

PROJECT MANUAL

**RFP/LOI# B2020004
FIRE ALARM UPGRADES**

**McGrath Judicial Complex
4800 Tower Hill Road
Wakefield, Rhode Island**



STATE OF RHODE ISLAND

RHODE ISLAND JUDICIARY

January 30, 2020

**EDWARD ROWSE ARCHITECTS, INC.
400 MASSASOIT AVENUE
SUITE 300, SECOND FLOOR
EAST PROVIDENCE, RI 02914
(401) 331-9200**

FIRE ALARM UPGRADES
McGRATH JUDICIAL COMPLEX

<u>SECTION NUMBER</u>	<u>TITLE</u>
00 01 10	Table of Contents
00 11 16	Bid Solicitation Form
00 01 17	List of Drawings
00 21 13	Instructions To Bidders (AIA - A701)
00 22 13	Supplementary Instructions To Bidders
00 42 13	Bid Form
00 43 13	Bid Bond (AIA - A310)
00 52 00	Form Of Agreement (AIA - A101)
00 52 13	Supplementary Form of Agreement
00 61 13	Performance and Payment Bonds (AIA - A312)
00 72 13	General Conditions (AIA - A201)
00 73 00	Supplementary General Conditions
00 73 46	Wage Determination Schedule
01 10 00	Summary
01 21 00	Allowances
01 31 00	Project Management and Coordination
01 32 00	Construction Progress Documentation
01 33 00	Submittal Procedures
01 40 00	Quality Requirements
01 60 00	Product Requirements
01 73 00	Execution
01 74 19	Construction Waste Management & Disposal
01 77 00	Closeout Procedures
01 78 39	Project Record Documents
26 00 00	Electrical
Appendix A	BCI Authorization Form
Appendix B	Rhode Island Judicial Purchasing Rules and Regulations and General Terms and Conditions of Purchase



STATE OF RHODE ISLAND AND PROVIDENCE PLANTATIONS

JUDICIAL PURCHASING OFFICE
 670 NEW LONDON AVENUE
 CRANSTON, RHODE ISLAND 02920
 TEL: 401-275-6527 FAX: 401-275-6530

BID SOLICITATION INFORMATION

DATE: 1/30/2020	RFP/LOI#: B2020004	Pre-Bid/Proposal Conference: Yes	Bonds Required: Performance ✓ Surety ✓
Project Name: Fire Alarm Upgrades – McGrath Judicial Complex		Pre-Bid attendance mandatory: Yes	
Opening Time & Date: 10:00a.m. March 3, 2020		Pre-Bid Time & Date: 7:30a.m. February 18, 2020	
Place: Purchasing Office, Room 1006 670 New London Ave. Cranston, RI 02920		Pre-Bid Location: Lobby	

The successful bidder will be required to furnish all insurance documentation as outlined in the attached Judicial Purchasing Rules & Regulations and General Terms & Conditions of Purchase which are available for inspection at <http://www.courts.ri.gov/PublicResources/purchasingrules/PDFs/Purchasing-Rules-Reg.pdf>.

This is a Request for Proposals ("RFP") for Fire Alarm Upgrades at the McGrath Judicial Complex located at 4800 Tower Hill Road, Wakefield, RI 02879. Specific bid solicitation information begins on page 3 of this document.

Proposals must be mailed or hand-delivered in a sealed envelope marked with the above RFP/LOI# and Project Name to: Rhode Island Traffic Tribunal
 Judicial Purchasing, Room 1006
 670 New London Avenue, Cranston RI, 02920

The Administrative Office of State Courts (the "AOSC") reserves the right to award a contract pursuant to this RFP on the basis of cost alone, to accept or reject any or all bids, and to act in its best interest including, but not limited to, directly negotiating with any vendor who submits a proposal in response to this RFP and to award a contract based upon the results of those negotiations alone. Proposals found to be technically or substantially nonresponsive at any point in the evaluation process will be rejected and not considered further. The AOSC may, at its sole option, elect to require presentations(s) by bidders in consideration for an award.

Questions concerning this solicitation may be e-mailed to the Supreme Court Purchasing Office at purchasing@courts.ri.gov no later than February 21, 2020. Please reference the RFP / LOI number on all correspondence. Answers to questions received, if any, will be posted on the internet as an Addendum to this bid solicitation.

Carla Ciccone
 Purchasing Agent
 Rhode Island Supreme Court

BIDDING DOCUMENTS

Bidding documents are available to view and print at <http://www.purchasing.ri.gov/bidding/ExternalBidListing.aspx> and/or <https://www.courts.ri.gov/PublicResources/purchasingrules/Pages/default.aspx>.

Bidders are required to provide Bid Security in the form of a Bid Bond, or a certified check payable to the State of Rhode Island, in the amount of a sum not less than five percent (5%) of the Bid Price. Bid surety must be attached to the Bid Form. Performance, labor and payment bonds will be required at time of award.

Questions concerning this RFP must be e-mailed to the office of the Architect at trowse@rowsearch.com no later than February 21, 2020. Please reference the RFP/LOI number on all correspondence. Answers to questions received, if any, will be discussed at the pre-bid/proposal conference and included in the meeting summary, which will be posted on the internet at: <http://www.purchasing.ri.gov/bidding/ExternalBidSearch.aspx> and <http://www.courts.ri.gov/>.

SECTION 00 01 17 – LIST OF DRAWINGS

GENERAL

The drawings for this project represent an integral part of the Contract Documents and they, along with the technical specifications, form a complete process of disseminating specific information required to perform the Work of this Project.

The following schedule indicates the Drawings of this Project, ordered for convenience only, and do not obligate the Contractor to perform the Work in any specific sequence, nor construed as specific Work for a specific trade, Subcontractor or supplier.

<u>DRAWING NUMBER</u>	<u>TITLE</u>
T1	Title Sheet
<u>ELECTRICAL</u>	
E0.01	Electrical Legend, Fixture Schedule and Notes
ED1.00	Lower Level Fire Alarm Demolition Plan
ED1.01	First Floor Fire Alarm Demolition Plan
E1.00	Lower Level Fire Alarm Plan
E1.01	First Floor Fire Alarm Plan

END OF SECTION 00 01 17

SECTION 00 21 13 – INSTRUCTIONS TO BIDDERS

AIA Document A701, Instructions to Bidders - 1997 Edition is included, following this page, as an integral part of the Bidding Documents. Provisions not amended or supplemented remain in full force and effect.

END OF SECTION 00 21 13

AIA[®] Document A701[™] – 1997

Instructions to Bidders

for the following PROJECT:
(Name and location or address)

THE OWNER:
(Name, legal status and address)

THE ARCHITECT:
(Name, legal status and address)

TABLE OF ARTICLES

- 1 DEFINITIONS
- 2 BIDDER'S REPRESENTATIONS
- 3 BIDDING DOCUMENTS
- 4 BIDDING PROCEDURES
- 5 CONSIDERATION OF BIDS
- 6 POST-BID INFORMATION
- 7 PERFORMANCE BOND AND PAYMENT BOND
- 8 FORM OF AGREEMENT BETWEEN OWNER AND CONTRACTOR

ADDITIONS AND DELETIONS:
The author of this document has added information needed for its completion. The author may also have revised the text of the original AIA standard form. An *Additions and Deletions Report* that notes added information as well as revisions to the standard form text is available from the author and should be reviewed. A vertical line in the left margin of this document indicates where the author has added necessary information and where the author has added to or deleted from the original AIA text.

This document has important legal consequences. Consultation with an attorney is encouraged with respect to its completion or modification.

ARTICLE 1 DEFINITIONS

§ 1.1 Bidding Documents include the Bidding Requirements and the proposed Contract Documents. The Bidding Requirements consist of the Advertisement or Invitation to Bid, Instructions to Bidders, Supplementary Instructions to Bidders, the bid form, and other sample bidding and contract forms. The proposed Contract Documents consist of the form of Agreement between the Owner and Contractor, Conditions of the Contract (General, Supplementary and other Conditions), Drawings, Specifications and all Addenda issued prior to execution of the Contract.

§ 1.2 Definitions set forth in the General Conditions of the Contract for Construction, AIA Document A201, or in other Contract Documents are applicable to the Bidding Documents.

§ 1.3 Addenda are written or graphic instruments issued by the Architect prior to the execution of the Contract which modify or interpret the Bidding Documents by additions, deletions, clarifications or corrections.

§ 1.4 A Bid is a complete and properly executed proposal to do the Work for the sums stipulated therein, submitted in accordance with the Bidding Documents.

§ 1.5 The Base Bid is the sum stated in the Bid for which the Bidder offers to perform the Work described in the Bidding Documents as the base, to which Work may be added or from which Work may be deleted for sums stated in Alternate Bids.

§ 1.6 An Alternate Bid (or Alternate) is an amount stated in the Bid to be added to or deducted from the amount of the Base Bid if the corresponding change in the Work, as described in the Bidding Documents, is accepted.

§ 1.7 A Unit Price is an amount stated in the Bid as a price per unit of measurement for materials, equipment or services or a portion of the Work as described in the Bidding Documents.

§ 1.8 A Bidder is a person or entity who submits a Bid and who meets the requirements set forth in the Bidding Documents.

§ 1.9 A Sub-bidder is a person or entity who submits a bid to a Bidder for materials, equipment or labor for a portion of the Work.

ARTICLE 2 BIDDER'S REPRESENTATIONS

§ 2.1 The Bidder by making a Bid represents that:

§ 2.1.1 The Bidder has read and understands the Bidding Documents or Contract Documents, to the extent that such documentation relates to the Work for which the Bid is submitted, and for other portions of the Project, if any, being bid concurrently or presently under construction.

§ 2.1.2 The Bid is made in compliance with the Bidding Documents.

§ 2.1.3 The Bidder has visited the site, become familiar with local conditions under which the Work is to be performed and has correlated the Bidder's personal observations with the requirements of the proposed Contract Documents.

§ 2.1.4 The Bid is based upon the materials, equipment and systems required by the Bidding Documents without exception.

ARTICLE 3 BIDDING DOCUMENTS

§ 3.1 COPIES

§ 3.1.1 Bidders may obtain complete sets of the Bidding Documents from the issuing office designated in the Advertisement or Invitation to Bid in the number and for the deposit sum, if any, stated therein. The deposit will be refunded to Bidders who submit a bona fide Bid and return the Bidding Documents in good condition within ten days after receipt of Bids. The cost of replacement of missing or damaged documents will be deducted from the deposit. A Bidder receiving a Contract award may retain the Bidding Documents and the Bidder's deposit will be refunded.

§ 3.1.2 Bidding Documents will not be issued directly to Sub-bidders unless specifically offered in the Advertisement or Invitation to Bid, or in supplementary instructions to bidders.

§ 3.1.3 Bidders shall use complete sets of Bidding Documents in preparing Bids; neither the Owner nor Architect assumes responsibility for errors or misinterpretations resulting from the use of incomplete sets of Bidding Documents.

§ 3.1.4 The Owner and Architect may make copies of the Bidding Documents available on the above terms for the purpose of obtaining Bids on the Work. No license or grant of use is conferred by issuance of copies of the Bidding Documents.

§ 3.2 INTERPRETATION OR CORRECTION OF BIDDING DOCUMENTS

§ 3.2.1 The Bidder shall carefully study and compare the Bidding Documents with each other, and with other work being bid concurrently or presently under construction to the extent that it relates to the Work for which the Bid is submitted, shall examine the site and local conditions, and shall at once report to the Architect errors, inconsistencies or ambiguities discovered.

§ 3.2.2 Bidders and Sub-bidders requiring clarification or interpretation of the Bidding Documents shall make a written request which shall reach the Architect at least seven days prior to the date for receipt of Bids.

§ 3.2.3 Interpretations, corrections and changes of the Bidding Documents will be made by Addendum. Interpretations, corrections and changes of the Bidding Documents made in any other manner will not be binding, and Bidders shall not rely upon them.

§ 3.3 SUBSTITUTIONS

§ 3.3.1 The materials, products and equipment described in the Bidding Documents establish a standard of required function, dimension, appearance and quality to be met by any proposed substitution.

§ 3.3.2 No substitution will be considered prior to receipt of Bids unless written request for approval has been received by the Architect at least ten days prior to the date for receipt of Bids. Such requests shall include the name of the material or equipment for which it is to be substituted and a complete description of the proposed substitution including drawings, performance and test data, and other information necessary for an evaluation. A statement setting forth changes in other materials, equipment or other portions of the Work, including changes in the work of other contracts that incorporation of the proposed substitution would require, shall be included. The burden of proof of the merit of the proposed substitution is upon the proposer. The Architect's decision of approval or disapproval of a proposed substitution shall be final.

§ 3.3.3 If the Architect approves a proposed substitution prior to receipt of Bids, such approval will be set forth in an Addendum. Bidders shall not rely upon approvals made in any other manner.

§ 3.3.4 No substitutions will be considered after the Contract award unless specifically provided for in the Contract Documents.

§ 3.4 ADDENDA

§ 3.4.1 Addenda will be transmitted to all who are known by the issuing office to have received a complete set of Bidding Documents.

§ 3.4.2 Copies of Addenda will be made available for inspection wherever Bidding Documents are on file for that purpose.

§ 3.4.3 Addenda will be issued no later than four days prior to the date for receipt of Bids except an Addendum withdrawing the request for Bids or one which includes postponement of the date for receipt of Bids.

§ 3.4.4 Each Bidder shall ascertain prior to submitting a Bid that the Bidder has received all Addenda issued, and the Bidder shall acknowledge their receipt in the Bid.

ARTICLE 4 BIDDING PROCEDURES

§ 4.1 PREPARATION OF BIDS

§ 4.1.1 Bids shall be submitted on the forms included with the Bidding Documents.

§ 4.1.2 All blanks on the bid form shall be legibly executed in a non-erasable medium.

§ 4.1.3 Sums shall be expressed in both words and figures. In case of discrepancy, the amount written in words shall govern.

§ 4.1.4 Interlineations, alterations and erasures must be initialed by the signer of the Bid.

§ 4.1.5 All requested Alternates shall be bid. If no change in the Base Bid is required, enter "No Change."

§ 4.1.6 Where two or more Bids for designated portions of the Work have been requested, the Bidder may, without forfeiture of the bid security, state the Bidder's refusal to accept award of less than the combination of Bids stipulated by the Bidder. The Bidder shall make no additional stipulations on the bid form nor qualify the Bid in any other manner.

§ 4.1.7 Each copy of the Bid shall state the legal name of the Bidder and the nature of legal form of the Bidder. The Bidder shall provide evidence of legal authority to perform within the jurisdiction of the Work. Each copy shall be signed by the person or persons legally authorized to bind the Bidder to a contract. A Bid by a corporation shall further give the state of incorporation and have the corporate seal affixed. A Bid submitted by an agent shall have a current power of attorney attached certifying the agent's authority to bind the Bidder.

§ 4.2 BID SECURITY

§ 4.2.1 Each Bid shall be accompanied by a bid security in the form and amount required if so stipulated in the Instructions to Bidders. The Bidder pledges to enter into a Contract with the Owner on the terms stated in the Bid and will, if required, furnish bonds covering the faithful performance of the Contract and payment of all obligations arising thereunder. Should the Bidder refuse to enter into such Contract or fail to furnish such bonds if required, the amount of the bid security shall be forfeited to the Owner as liquidated damages, not as a penalty. The amount of the bid security shall not be forfeited to the Owner in the event the Owner fails to comply with Section 6.2.

§ 4.2.2 If a surety bond is required, it shall be written on AIA Document A310, Bid Bond, unless otherwise provided in the Bidding Documents, and the attorney-in-fact who executes the bond on behalf of the surety shall affix to the bond a certified and current copy of the power of attorney.

§ 4.2.3 The Owner will have the right to retain the bid security of Bidders to whom an award is being considered until either (a) the Contract has been executed and bonds, if required, have been furnished, or (b) the specified time has elapsed so that Bids may be withdrawn or (c) all Bids have been rejected.

§ 4.3 SUBMISSION OF BIDS

§ 4.3.1 All copies of the Bid, the bid security, if any, and any other documents required to be submitted with the Bid shall be enclosed in a sealed opaque envelope. The envelope shall be addressed to the party receiving the Bids and shall be identified with the Project name, the Bidder's name and address and, if applicable, the designated portion of the Work for which the Bid is submitted. If the Bid is sent by mail, the sealed envelope shall be enclosed in a separate mailing envelope with the notation "SEALED BID ENCLOSED" on the face thereof.

§ 4.3.2 Bids shall be deposited at the designated location prior to the time and date for receipt of Bids. Bids received after the time and date for receipt of Bids will be returned unopened.

§ 4.3.3 The Bidder shall assume full responsibility for timely delivery at the location designated for receipt of Bids.

§ 4.3.4 Oral, telephonic, telegraphic, facsimile or other electronically transmitted bids will not be considered.

§ 4.4 MODIFICATION OR WITHDRAWAL OF BID

§ 4.4.1 A Bid may not be modified, withdrawn or canceled by the Bidder during the stipulated time period following the time and date designated for the receipt of Bids, and each Bidder so agrees in submitting a Bid.

§ 4.4.2 Prior to the time and date designated for receipt of Bids, a Bid submitted may be modified or withdrawn by notice to the party receiving Bids at the place designated for receipt of Bids. Such notice shall be in writing over the

signature of the Bidder. Written confirmation over the signature of the Bidder shall be received, and date- and time-stamped by the receiving party on or before the date and time set for receipt of Bids. A change shall be so worded as not to reveal the amount of the original Bid.

§ 4.4.3 Withdrawn Bids may be resubmitted up to the date and time designated for the receipt of Bids provided that they are then fully in conformance with these Instructions to Bidders.

§ 4.4.4 Bid security, if required, shall be in an amount sufficient for the Bid as resubmitted.

ARTICLE 5 CONSIDERATION OF BIDS

§ 5.1 OPENING OF BIDS

At the discretion of the Owner, if stipulated in the Advertisement or Invitation to Bid, the properly identified Bids received on time will be publicly opened and will be read aloud. An abstract of the Bids may be made available to Bidders.

§ 5.2 REJECTION OF BIDS

The Owner shall have the right to reject any or all Bids. A Bid not accompanied by a required bid security or by other data required by the Bidding Documents, or a Bid which is in any way incomplete or irregular is subject to rejection.

§ 5.3 ACCEPTANCE OF BID (AWARD)

§ 5.3.1 It is the intent of the Owner to award a Contract to the lowest qualified Bidder provided the Bid has been submitted in accordance with the requirements of the Bidding Documents and does not exceed the funds available.

The Owner shall have the right to waive informalities and irregularities in a Bid received and to accept the Bid which, in the Owner's judgment, is in the Owner's own best interests.

§ 5.3.2 The Owner shall have the right to accept Alternates in any order or combination, unless otherwise specifically provided in the Bidding Documents, and to determine the low Bidder on the basis of the sum of the Base Bid and Alternates accepted.

ARTICLE 6 POST-BID INFORMATION

§ 6.1 CONTRACTOR'S QUALIFICATION STATEMENT

Bidders to whom award of a Contract is under consideration shall submit to the Architect, upon request, a properly executed AIA Document A305, Contractor's Qualification Statement, unless such a Statement has been previously required and submitted as a prerequisite to the issuance of Bidding Documents.

§ 6.2 OWNER'S FINANCIAL CAPABILITY

The Owner shall, at the request of the Bidder to whom award of a Contract is under consideration and no later than seven days prior to the expiration of the time for withdrawal of Bids, furnish to the Bidder reasonable evidence that financial arrangements have been made to fulfill the Owner's obligations under the Contract. Unless such reasonable evidence is furnished, the Bidder will not be required to execute the Agreement between the Owner and Contractor.

§ 6.3 SUBMITTALS

§ 6.3.1 The Bidder shall, as soon as practicable or as stipulated in the Bidding Documents, after notification of selection for the award of a Contract, furnish to the Owner through the Architect in writing:

- .1 a designation of the Work to be performed with the Bidder's own forces;
- .2 names of the manufacturers, products, and the suppliers of principal items or systems of materials and equipment proposed for the Work; and
- .3 names of persons or entities (including those who are to furnish materials or equipment fabricated to a special design) proposed for the principal portions of the Work.

§ 6.3.2 The Bidder will be required to establish to the satisfaction of the Architect and Owner the reliability and responsibility of the persons or entities proposed to furnish and perform the Work described in the Bidding Documents.

§ 6.3.3 Prior to the execution of the Contract, the Architect will notify the Bidder in writing if either the Owner or Architect, after due investigation, has reasonable objection to a person or entity proposed by the Bidder. If the Owner or Architect has reasonable objection to a proposed person or entity, the Bidder may, at the Bidder's option, (1)

withdraw the Bid or (2) submit an acceptable substitute person or entity with an adjustment in the Base Bid or Alternate Bid to cover the difference in cost occasioned by such substitution. The Owner may accept the adjusted bid price or disqualify the Bidder. In the event of either withdrawal or disqualification, bid security will not be forfeited.

§ 6.3.4 Persons and entities proposed by the Bidder and to whom the Owner and Architect have made no reasonable objection must be used on the Work for which they were proposed and shall not be changed except with the written consent of the Owner and Architect.

ARTICLE 7 PERFORMANCE BOND AND PAYMENT BOND

§ 7.1 BOND REQUIREMENTS

§ 7.1.1 If stipulated in the Bidding Documents, the Bidder shall furnish bonds covering the faithful performance of the Contract and payment of all obligations arising thereunder. Bonds may be secured through the Bidder's usual sources.

§ 7.1.2 If the furnishing of such bonds is stipulated in the Bidding Documents, the cost shall be included in the Bid. If the furnishing of such bonds is required after receipt of bids and before execution of the Contract, the cost of such bonds shall be added to the Bid in determining the Contract Sum.

§ 7.1.3 If the Owner requires that bonds be secured from other than the Bidder's usual sources, changes in cost will be adjusted as provided in the Contract Documents.

§ 7.2 TIME OF DELIVERY AND FORM OF BONDS

§ 7.2.1 The Bidder shall deliver the required bonds to the Owner not later than three days following the date of execution of the Contract. If the Work is to be commenced prior thereto in response to a letter of intent, the Bidder shall, prior to commencement of the Work, submit evidence satisfactory to the Owner that such bonds will be furnished and delivered in accordance with this Section 7.2.1.

§ 7.2.2 Unless otherwise provided, the bonds shall be written on AIA Document A312, Performance Bond and Payment Bond. Both bonds shall be written in the amount of the Contract Sum.

§ 7.2.3 The bonds shall be dated on or after the date of the Contract.

§ 7.2.4 The Bidder shall require the attorney-in-fact who executes the required bonds on behalf of the surety to affix thereto a certified and current copy of the power of attorney.

ARTICLE 8 FORM OF AGREEMENT BETWEEN OWNER AND CONTRACTOR

Unless otherwise required in the Bidding Documents, the Agreement for the Work will be written on AIA Document A101, Standard Form of Agreement Between Owner and Contractor Where the Basis of Payment Is a Stipulated Sum.

SECTION 00 22 13 – SUPPLEMENTARY INSTRUCTIONS TO BIDDERS

The following supplements modify, change, delete from or add to "Instructions to Bidders," AIA Document A701, Fifth Edition, 1997. Where any Article is modified or any Paragraph or Subparagraph is modified or deleted, the unaltered provisions of that Article, Paragraph, or Subparagraph shall remain in effect.

- 1.1 Add the following:
The proposed Bidding Documents also include the Rhode Island Judicial Purchasing Rules and Regulations and General Terms and Conditions of Purchase along with any Judicial Purchasing Orders issued for the Project.

ARTICLE 3 BIDDING DOCUMENTS

- 3.1.1 Delete in its entirety and substitute the following:

3.1.1 Bidding documents are available to view and print at <http://www.purchasing.ri.gov/bidding/ExternalBidListing.aspx> and/or <https://www.courts.ri.gov/PublicResources/purchasingrules/Pages/default.aspx>. The bidder shall be responsible for all costs associated with printing hard copies of bidding documents.

Bidders are required to provide Bid Security in the form of a Bid Bond, or a certified check payable to the State of Rhode Island, in the amount of a sum not less than five percent (5%) of the Bid Price. Bid surety must be attached to the Bid Form. Performance, labor and payment bonds will be required prior to the date of execution of the contract.

Other bidding requirements are set forth in the Instructions to Bidders section of the Bidding Documents.

- 3.1.2 Delete in its entirety without substitution.

- 3.2.4 Add the following:
A MANDATORY pre-bid conference will be held by the Owner.

Date, Time and Location:	Per Bid Solicitation Form, Section 00 11 16
Contact Person:	Stephen J. Kerr, Asst. State Court Administrator For Facilities, Operations and Security Licht Judicial Complex 250 Benefit Street Providence, RI 02903 401-222-4999 skerr@courts.ri.gov

ARTICLE 4 BIDDING PROCEDURES

Add the following sub-paragraphs to 4.3 Submission of Bids

4.3.5 Bids will be evaluated on the basis of the relative merits of the proposal, in addition to price. There will be no public opening and reading of responses received by the Owner pursuant to this request, other than to name those Bidders who have submitted proposals.

4.3.6 Potential Bidders are advised to review all sections of this Request carefully and to completely comply with all instructions as failure to provide a complete submission as described herein may result in rejection of the proposal as incomplete and nonresponsive.

4.3.7 All costs associated with developing or submitting a proposal in response to this Request, or to provide oral or written clarification of its content, shall be borne by the Bidder. The AOSC (Administrative Office of State Courts) assumes no responsibility for these costs.

4.3.8 All pricing submitted will be considered firm and fixed unless otherwise indicated herein.

4.3.9 Bids misdirected to other Judiciary locations or which are for whatever reason otherwise not received by the Judicial Purchasing Office by the time for opening, will be deemed late and will not be considered. The time clock in the Judicial Purchasing Office shall be the point of reference for purposes of this requirement.

4.3.10 It is intended that an award pursuant to this Request will be made to a prime contractor, who will assume responsibility for all aspects of the Work. Joint venture and cooperative proposals will not be considered, but subcontracts are permitted, provided that their use is clearly indicated in the Bid, and the subcontractor(s) proposed are clearly identified therein.

ARTICLE 5 CONSIDERATION OF BIDS

Delete 5.1 in its entirety and substitute the following:

5.1 There will be no public opening and reading of the Bids received by the Judicial Purchasing Office Pursuant to this request. A list of the Bidders will be made available upon request.

Add the following Clause to 5.3.1:

5.3.1 Delete 5.3.1 in its entirety and substitute the following:

All submissions will be evaluated by a review committee. The contract shall be awarded on the basis of the highest evaluated Bid. Bids will be evaluated on a percentage basis as follows:

Ability to meet specifications	25%
Experience	40%
Price	<u>35%</u>
Total	100%

ARTICLE 6 POST-BID INFORMATION

6.2 Delete in its entirety without substitution.

ARTICLE 7 PERFORMANCE BOND AND PAYMENT BOND

7.1.1 through 7.1.3 Delete in its entirety, and substitute the following:

7.1.1 The Bidder shall furnish bonds covering the faithful performance of the Contract and payment of all obligations arising thereunder. Bonds must be secured through a surety company licensed to do business in the State of Rhode Island. Their costs shall be included in the Bid.

7.2.1 Delete in its entirety, and substitute the following:

7.2.1 The Bidder shall deliver the required bonds to the Owner prior to the date of execution of the Contract.

ADD ARTICLE 9 SPECIAL PROJECT BID INFORMATION AND CONDITIONS

9.1 Field Observations and Measurements

9.1.1 Bidders are solely responsible to conduct field observations and to take all field measurements of all conditions that may affect the Work to be performed.

9.1.1.1 Bidders shall survey all site conditions and shall thoroughly familiarize themselves with the Work to be performed prior to submitting a Bid. Contractors will be responsible for providing all materials and labor, at no additional cost, when existing conditions or systems require modifications and the required modifications are in locations which were available for inspection prior to Bid or in locations which could reasonably have been inspected prior to bid.

9.1.2 Bidders shall be responsible for field measurement. The dimensions shown on Drawings provided by owner or Architect are to be used as a guide only and are not to be relied upon by Bidders for any purpose whatsoever including, but not limited to, estimates and/or final measurements.

9.2 BIDDER'S REPRESENTATIONS

9.2.1 By submitting a Bid, the Bidder warrants that it has inspected the site, has completely familiarized itself with all site conditions, has correlated this information with the requirements of the Bidding Documents, has full knowledge of the work required, and assumes full responsibility for the same.

9.2.2 By submitting a Bid, the Bidder and all proposed subcontractors warrant that they have carefully and thoroughly reviewed all Bidding Documents and have found them to be complete and free from errors, inconsistencies and/or ambiguities and are sufficient for the purpose intended. Bidder assumes full responsibility for any errors, inconsistencies and/or ambiguities in the Bidding Documents and agrees to hold harmless the Owner and Architect for any and all damages or injuries that may result from the same.

9.2.3 By submitting a Bid, the Bidder warrants that its employees, agents, and subcontractors are all adequately trained, skilled and experienced in the type of Work to be performed.

9.2.4 Neither the Bidder nor any of its employees, agents, suppliers or contractors have relied upon any verbal representations from the Owner, its employees or agents including architects, engineers or consultants, in assembling the Bid figure.

9.2.5 The Bid figure is based solely upon the Bidding Documents and properly issued written Addenda and not upon any other representations, written or oral.

9.2.6 After award of the Contract, no claim(s) for additional compensation resulting from any misunderstanding of the Bidding Documents, any errors, inconsistencies, or ambiguities in the Bidding Documents, or conditions at the site, will be entertained.

9.3 DUPLICATION OF ITEMS OF WORK

9.3.1 Where items of work have been duplicated in portions of the Drawings and Specifications, it will be assumed that the Bidders have specifically included the duplicated items in their Bid, unless the Owner has been notified, in writing, prior to submittal of Bids that duplication exists and the Owner issues instruction to establish limits of work and allocation of responsibility.

9.3.2 In the event that the Owner does not receive notification pertaining to duplication of items prior to Bidding and such duplications do occur after submittal of a Bid, the Owner shall then assign the duplicated items of Work to one of the parties and the Owner shall then be entitled to full credit for the items of work from the other party.

9.3.3 In the event that materials and/or equipment have been specified in the Bidding Documents with more than one standard of quality, it will be assumed that the Bidder concerned included

materials and or equipment with the higher quality standards in their Bid, unless the Owner agreed otherwise in writing.

9.4 ACCEPTANCE OF CONDITIONS

9.4.1 The submission of a Bid Proposal will be considered by the Owner as acceptance by the Bidder of all requirements and stipulations contained in the Bidding Documents, and any and all site conditions.

9.5 SITE INSPECTION INFORMATION

9.5.1 The site is available for inspection and must be scheduled in advance. Contractors must set up a time for inspection with Stephen J. Kerr, Asst. State Court Administrator for Facilities, Operations and Security, Rhode Island Administrative Office of State Courts, Licht Judicial Complex, 250 Benefit Street, Providence, RI 02903, 401-222-4999.

9.6 CONTRACT PERIOD AND LIQUIDATED DAMAGES

9.6.1 Bidder must agree to commence work within 10 days after issuance of a written "Notice to Proceed" with the Owner and to substantially complete the project within the time limit indicated on the proposal form.

9.6.2 If the Contractor fails to complete the work within the specified time the Contractor shall pay the Owner as liquidated damages, the sum of \$250 dollars per day for each day of delay.

END OF SECTION 00 22 13

SECTION 00 42 13 – BID FORM

TO: State of Rhode Island
Judicial Purchasing Office
Rhode Island Traffic Tribunal
670 New London Avenue, Room 1006
Cranston, RI 02920

PROJECT: Fire Alarm Upgrades
McGrath Judicial Complex
4800 Tower Hill Road
Wakefield, Rhode Island 02879

DATE: _____

SUBMITTED BY: _____
(include address _____
tel. no., and _____
license no. as _____
applicable) _____

1. BID

Having examined the Site and all matters referred to in the Bid Information Sheet, the Instructions to Bidders, and the Bidding Documents, we, the undersigned, hereby propose to enter into a Contract to perform the Work for the sum of:

Base Bid

\$,					.		
----	--	--	--	--	---	--	--	--	--	---	--	--

(Numeric)

(Written)

We have included the required Bid Security in compliance with the Instructions to Bidders and the allowance of ten thousand dollars (\$10,000) in the base Bid.

2. ACCEPTANCE

This Bid shall be irrevocable for ninety (90) days from the Bid closing date. If this Bid is accepted by the Owner within ninety (90) days, we will:

- a. execute an Agreement subject to compliance with required state regulatory agency approvals as described in the Instructions to Bidders;
- b. furnish the required bonds in compliance with the amended provisions of the Instructions to Bidders; and
- c. commence work within seven (7) days from the issuance date of the Judicial Purchase Order for the Project.

If we fail to comply with any of the above we immediately forfeit the Bid Security while preserving any additional damages, remedies or rights available to the Owner at law.

In the event our Bid is not accepted within the ninety (90) day period, the Bid Security shall be returned to the undersigned in accordance with the Instructions to Bidders; unless a mutually satisfactory arrangement is made in writing for its retention and validity for an extended period of time.

3. CONTRACT TIME

If this Bid is accepted, we will fully complete the Work in ninety (90) calendar days from the issuance date of the Judicial Purchase Order. The work hours shall be from 5:00 PM to 12:00 AM Monday through Friday. Saturday work may be allowed if requested in writing to Stephen Kerr, Asst. State Court Administrator for Facilities, Operations and Security, Rhode Island Administrative Office of State Courts, Licht Judicial Complex, 250 Benefit Street, Providence, RI 02903.

The Contract completion time may be extended only by written agreement of the parties.

4. ADDENDA

The following Addenda have been received. The noted modifications to the Bidding Documents have been considered and all costs are included in the Bid Sum.

Addendum No. 1, dated _____

Addendum No. 2, dated _____

5. ALLOWANCES

The Bidder shall include in its Base Bid Price an allowance of ten thousand dollars (**\$10,000**) for additional work that may be required and approved by Owner and Architect. Funds will be drawn from allowances only by a properly executed and approved Change Order. At the closeout of the Contract, funds remaining in allowances will be credited to Owner by Change Order.

LICENSE NUMBER REQUIREMENT:

As required by Section 5-65-23 of the Rhode Island General Laws my Rhode Island license number for the work to be performed by this firm as prime contractor is:

LICENSE NUMBER: _____

6. REFERENCES

Please submit a list of references with whom you have contracted to do similar work including the dates of service. A minimum of four (4) references are required. Please list all information below:

Company Name	Contact Person	Telephone #	Dates of Service

Have you or your firm been subject to suspension, debarment or criminal conviction by the AOSC, the State of Rhode Island, or any other jurisdiction?

Yes: _____ No: _____

Has the AOSC and/or the State of Rhode Island ever terminated contracts with your firm for cause?

Yes: _____ No: _____

Has your firm ever withdrawn from a contract with the AOSC and/or the State of Rhode Island during its performance?

Yes: _____ No: _____

Have you or your firm been involved in litigation against the AOSC and/or the State of Rhode Island?

Yes: _____ No: _____

If you answered yes to any of the foregoing, please explain the circumstances below. If you or your firm have been involved in litigation against the AOSC and/or the State of Rhode Island, please include the case caption, case number and status. (If more space is needed, please attach separate sheet and submit with the bid.)

7. BID FORM SIGNATURES

(Bidder's Printed Name)

CORPORATE SEAL

By: _____
(Signature)

Title: _____

Date: _____

END OF SECTION 00 42 13

SECTION 00 43 13 – BID BOND

1. BID BOND

AIA Document A310, Bid Bond - 2010 Edition, as amended, which appears on the following page is an integral part of the Bidding Documents. Provisions not amended or supplemented remain in full force and effect.

END OF SECTION 00 43 13



AIA[®] Document A310[™] – 2010

Bid Bond

CONTRACTOR:
(Name, legal status and address)

SURETY:
(Name, legal status and principal place of business)

OWNER:
(Name, legal status and address)

BOND AMOUNT: \$

PROJECT:
(Name, location or address, and Project number, if any)

ADDITIONS AND DELETIONS:
The author of this document has added information needed for its completion. The author may also have revised the text of the original AIA standard form. An *Additions and Deletions Report* that notes added information as well as revisions to the standard form text is available from the author and should be reviewed. A vertical line in the left margin of this document indicates where the author has added necessary information and where the author has added to or deleted from the original AIA text.

This document has important legal consequences. Consultation with an attorney is encouraged with respect to its completion or modification.

Any singular reference to Contractor, Surety, Owner or other party shall be considered plural where applicable.

The Contractor and Surety are bound to the Owner in the amount set forth above, for the payment of which the Contractor and Surety bind themselves, their heirs, executors, administrators, successors and assigns, jointly and severally, as provided herein. The conditions of this Bond are such that if the Owner accepts the bid of the Contractor within the time specified in the bid documents, or within such time period as may be agreed to by the Owner and Contractor, and the Contractor either (1) enters into a contract with the Owner in accordance with the terms of such bid, and gives such bond or bonds as may be specified in the bidding or Contract Documents, with a surety admitted in the jurisdiction of the Project and otherwise acceptable to the Owner, for the faithful performance of such Contract and for the prompt payment of labor and material furnished in the prosecution thereof; or (2) pays to the Owner the difference, not to exceed the amount of this Bond, between the amount specified in said bid and such larger amount for which the Owner may in good faith contract with another party to perform the work covered by said bid, then this obligation shall be null and void, otherwise to remain in full force and effect. The Surety hereby waives any notice of an agreement between the Owner and Contractor to extend the time in which the Owner may accept the bid. Waiver of notice by the Surety shall not apply to any extension exceeding sixty (60) days in the aggregate beyond the time for acceptance of bids specified in the bid documents, and the Owner and Contractor shall obtain the Surety's consent for an extension beyond sixty (60) days.

If this Bond is issued in connection with a subcontractor's bid to a Contractor, the term Contractor in this Bond shall be deemed to be Subcontractor and the term Owner shall be deemed to be Contractor.

When this Bond has been furnished to comply with a statutory or other legal requirement in the location of the Project, any provision in this Bond conflicting with said statutory or legal requirement shall be deemed deleted herefrom and provisions conforming to such statutory or other legal requirement shall be deemed incorporated herein. When so furnished, the intent is that this Bond shall be construed as a statutory bond and not as a common law bond.

Init.

Signed and sealed this day of ,

(Contractor as Principal) (Seal)

(Witness)

(Title)

(Surety) (Seal)

(Witness)

(Title)

SECTION 00 52 00 – FORM OF AGREEMENT

1. AGREEMENT

AIA Document A101, Standard Form of Agreement Between Owner and Contractor - 2007 Edition, as amended, forms the basis of the Contract between the Owner and Contractor, in addition to the Rhode Island Judicial Purchasing Rules and Regulations and General Terms and Conditions of Purchase, as well as the Judicial Purchase Order issued for the project. Those documents are included on the following pages and are an integral part of the Bidding Documents. Provisions not amended or supplemented remain in full force and effect.

END OF SECTION 00 52 13

AIA[®] Document A101[™] – 2007

Standard Form of Agreement Between Owner and Contractor where the basis of payment is a Stipulated Sum

AGREEMENT made as of the day of in the year
(In words, indicate day, month and year.)

BETWEEN the Owner:
(Name, legal status, address and other information)

and the Contractor:
(Name, legal status, address and other information)

for the following Project:
(Name, location and detailed description)

The Architect:
(Name, legal status, address and other information)

The Owner and Contractor agree as follows.

ADDITIONS AND DELETIONS:
The author of this document has added information needed for its completion. The author may also have revised the text of the original AIA standard form. An *Additions and Deletions Report* that notes added information as well as revisions to the standard form text is available from the author and should be reviewed. A vertical line in the left margin of this document indicates where the author has added necessary information and where the author has added to or deleted from the original AIA text.

This document has important legal consequences. Consultation with an attorney is encouraged with respect to its completion or modification.

AIA Document A201[™]–2007, General Conditions of the Contract for Construction, is adopted in this document by reference. Do not use with other general conditions unless this document is modified.

Init.

AIA Document A101[™] – 2007. Copyright © 1915, 1918, 1925, 1937, 1951, 1958, 1961, 1963, 1967, 1974, 1977, 1987, 1991, 1997 and 2007 by The American Institute of Architects. All rights reserved. **WARNING: This AIA[®] Document is protected by U.S. Copyright Law and International Treaties. Unauthorized reproduction or distribution of this AIA[®] Document, or any portion of it, may result in severe civil and criminal penalties, and will be prosecuted to the maximum extent possible under the law.** This document was produced by AIA software at 14:42:13 on 05/27/2016 under Order No.9505439256_1 which expires on 03/28/2017, and is not for resale.

User Notes:

(1148340554)

TABLE OF ARTICLES

1	THE CONTRACT DOCUMENTS
2	THE WORK OF THIS CONTRACT
3	DATE OF COMMENCEMENT AND SUBSTANTIAL COMPLETION
4	CONTRACT SUM
5	PAYMENTS
6	DISPUTE RESOLUTION
7	TERMINATION OR SUSPENSION
8	MISCELLANEOUS PROVISIONS
9	ENUMERATION OF CONTRACT DOCUMENTS
10	INSURANCE AND BONDS

ARTICLE 1 THE CONTRACT DOCUMENTS

The Contract Documents consist of this Agreement, Conditions of the Contract (General, Supplementary and other Conditions), Drawings, Specifications, Addenda issued prior to execution of this Agreement, other documents listed in this Agreement and Modifications issued after execution of this Agreement, all of which form the Contract, and are as fully a part of the Contract as if attached to this Agreement or repeated herein. The Contract represents the entire and integrated agreement between the parties hereto and supersedes prior negotiations, representations or agreements, either written or oral. An enumeration of the Contract Documents, other than a Modification, appears in Article 9.

ARTICLE 2 THE WORK OF THIS CONTRACT

The Contractor shall fully execute the Work described in the Contract Documents, except as specifically indicated in the Contract Documents to be the responsibility of others.

ARTICLE 3 DATE OF COMMENCEMENT AND SUBSTANTIAL COMPLETION

§ 3.1 The date of commencement of the Work shall be the date of this Agreement unless a different date is stated below or provision is made for the date to be fixed in a notice to proceed issued by the Owner.

(Insert the date of commencement if it differs from the date of this Agreement or, if applicable, state that the date will be fixed in a notice to proceed.)

If, prior to the commencement of the Work, the Owner requires time to file mortgages and other security interests, the Owner's time requirement shall be as follows:

§ 3.2 The Contract Time shall be measured from the date of commencement.

§ 3.3 The Contractor shall achieve Substantial Completion of the entire Work not later than () days from the date of commencement, or as follows:

(Insert number of calendar days. Alternatively, a calendar date may be used when coordinated with the date of commencement. If appropriate, insert requirements for earlier Substantial Completion of certain portions of the Work.)

Init.

Portion of Work

Substantial Completion Date

, subject to adjustments of this Contract Time as provided in the Contract Documents.
(Insert provisions, if any, for liquidated damages relating to failure to achieve Substantial Completion on time or for bonus payments for early completion of the Work.)

ARTICLE 4 CONTRACT SUM

§ 4.1 The Owner shall pay the Contractor the Contract Sum in current funds for the Contractor’s performance of the Contract. The Contract Sum shall be (\$), subject to additions and deductions as provided in the Contract Documents.

§ 4.2 The Contract Sum is based upon the following alternates, if any, which are described in the Contract Documents and are hereby accepted by the Owner:

(State the numbers or other identification of accepted alternates. If the bidding or proposal documents permit the Owner to accept other alternates subsequent to the execution of this Agreement, attach a schedule of such other alternates showing the amount for each and the date when that amount expires.)

§ 4.3 Unit prices, if any:

(Identify and state the unit price; state quantity limitations, if any, to which the unit price will be applicable.)

Item	Units and Limitations	Price Per Unit (\$0.00)
------	-----------------------	-------------------------

§ 4.4 Allowances included in the Contract Sum, if any:

(Identify allowance and state exclusions, if any, from the allowance price.)

Item	Price
------	-------

ARTICLE 5 PAYMENTS

§ 5.1 PROGRESS PAYMENTS

§ 5.1.1 Based upon Applications for Payment submitted to the Architect by the Contractor and Certificates for Payment issued by the Architect, the Owner shall make progress payments on account of the Contract Sum to the Contractor as provided below and elsewhere in the Contract Documents.

§ 5.1.2 The period covered by each Application for Payment shall be one calendar month ending on the last day of the month, or as follows:

§ 5.1.3 Provided that an Application for Payment is received by the Architect not later than the day of a month, the Owner shall make payment of the certified amount to the Contractor not later than the day of the month. If an Application for Payment is received by the Architect after the application date fixed above, payment shall be made by the Owner not later than () days after the Architect receives the Application for Payment.

(Federal, state or local laws may require payment within a certain period of time.)

§ 5.1.4 Each Application for Payment shall be based on the most recent schedule of values submitted by the Contractor in accordance with the Contract Documents. The schedule of values shall allocate the entire Contract Sum among the various portions of the Work. The schedule of values shall be prepared in such form and supported by such data to substantiate its accuracy as the Architect may require. This schedule, unless objected to by the Architect, shall be used as a basis for reviewing the Contractor’s Applications for Payment.

§ 5.1.5 Applications for Payment shall show the percentage of completion of each portion of the Work as of the end of the period covered by the Application for Payment.

§ 5.1.6 Subject to other provisions of the Contract Documents, the amount of each progress payment shall be computed as follows:

- .1 Take that portion of the Contract Sum properly allocable to completed Work as determined by multiplying the percentage completion of each portion of the Work by the share of the Contract Sum allocated to that portion of the Work in the schedule of values, less retainage of percent (%). Pending final determination of cost to the Owner of changes in the Work, amounts not in dispute shall be included as provided in Section 7.3.9 of AIA Document A201™–2007, General Conditions of the Contract for Construction;
- .2 Add that portion of the Contract Sum properly allocable to materials and equipment delivered and suitably stored at the site for subsequent incorporation in the completed construction (or, if approved in advance by the Owner, suitably stored off the site at a location agreed upon in writing), less retainage of percent (%);
- .3 Subtract the aggregate of previous payments made by the Owner; and
- .4 Subtract amounts, if any, for which the Architect has withheld or nullified a Certificate for Payment as provided in Section 9.5 of AIA Document A201–2007.

§ 5.1.7 The progress payment amount determined in accordance with Section 5.1.6 shall be further modified under the following circumstances:

- .1 Add, upon Substantial Completion of the Work, a sum sufficient to increase the total payments to the full amount of the Contract Sum, less such amounts as the Architect shall determine for incomplete Work, retainage applicable to such work and unsettled claims; and
(Section 9.8.5 of AIA Document A201–2007 requires release of applicable retainage upon Substantial Completion of Work with consent of surety, if any.)
- .2 Add, if final completion of the Work is thereafter materially delayed through no fault of the Contractor, any additional amounts payable in accordance with Section 9.10.3 of AIA Document A201–2007.

§ 5.1.8 Reduction or limitation of retainage, if any, shall be as follows:

(If it is intended, prior to Substantial Completion of the entire Work, to reduce or limit the retainage resulting from the percentages inserted in Sections 5.1.6.1 and 5.1.6.2 above, and this is not explained elsewhere in the Contract Documents, insert here provisions for such reduction or limitation.)

§ 5.1.9 Except with the Owner's prior approval, the Contractor shall not make advance payments to suppliers for materials or equipment which have not been delivered and stored at the site.

§ 5.2 FINAL PAYMENT

§ 5.2.1 Final payment, constituting the entire unpaid balance of the Contract Sum, shall be made by the Owner to the Contractor when

- .1 the Contractor has fully performed the Contract except for the Contractor's responsibility to correct Work as provided in Section 12.2.2 of AIA Document A201–2007, and to satisfy other requirements, if any, which extend beyond final payment; and
- .2 a final Certificate for Payment has been issued by the Architect.

§ 5.2.2 The Owner's final payment to the Contractor shall be made no later than 30 days after the issuance of the Architect's final Certificate for Payment, or as follows:

ARTICLE 6 DISPUTE RESOLUTION

§ 6.1 INITIAL DECISION MAKER

The Architect will serve as Initial Decision Maker pursuant to Section 15.2 of AIA Document A201–2007, unless the parties appoint below another individual, not a party to this Agreement, to serve as Initial Decision Maker.

Init.

AIA Document A101™ – 2007. Copyright © 1915, 1918, 1925, 1937, 1951, 1958, 1961, 1963, 1967, 1974, 1977, 1987, 1991, 1997 and 2007 by The American Institute of Architects. All rights reserved. **WARNING: This AIA® Document is protected by U.S. Copyright Law and International Treaties. Unauthorized reproduction or distribution of this AIA® Document, or any portion of it, may result in severe civil and criminal penalties, and will be prosecuted to the maximum extent possible under the law.** This document was produced by AIA software at 14:42:13 on 05/27/2016 under Order No.9505439256_1 which expires on 03/28/2017, and is not for resale.

User Notes:

(1148340554)

(If the parties mutually agree, insert the name, address and other contact information of the Initial Decision Maker, if other than the Architect.)

§ 6.2 BINDING DISPUTE RESOLUTION

For any Claim subject to, but not resolved by, mediation pursuant to Section 15.3 of AIA Document A201–2007, the method of binding dispute resolution shall be as follows:

(Check the appropriate box. If the Owner and Contractor do not select a method of binding dispute resolution below, or do not subsequently agree in writing to a binding dispute resolution method other than litigation, Claims will be resolved by litigation in a court of competent jurisdiction.)

- Arbitration pursuant to Section 15.4 of AIA Document A201–2007
- Litigation in a court of competent jurisdiction
- Other *(Specify)*

ARTICLE 7 TERMINATION OR SUSPENSION

§ 7.1 The Contract may be terminated by the Owner or the Contractor as provided in Article 14 of AIA Document A201–2007.

§ 7.2 The Work may be suspended by the Owner as provided in Article 14 of AIA Document A201–2007.

ARTICLE 8 MISCELLANEOUS PROVISIONS

§ 8.1 Where reference is made in this Agreement to a provision of AIA Document A201–2007 or another Contract Document, the reference refers to that provision as amended or supplemented by other provisions of the Contract Documents.

§ 8.2 Payments due and unpaid under the Contract shall bear interest from the date payment is due at the rate stated below, or in the absence thereof, at the legal rate prevailing from time to time at the place where the Project is located.
(Insert rate of interest agreed upon, if any.)

%

§ 8.3 The Owner's representative:
(Name, address and other information)

§ 8.4 The Contractor's representative:
(Name, address and other information)

§ 8.5 Neither the Owner's nor the Contractor's representative shall be changed without ten days written notice to the other party.

§ 8.6 Other provisions:

ARTICLE 9 ENUMERATION OF CONTRACT DOCUMENTS

§ 9.1 The Contract Documents, except for Modifications issued after execution of this Agreement, are enumerated in the sections below.

§ 9.1.1 The Agreement is this executed AIA Document A101-2007, Standard Form of Agreement Between Owner and Contractor.

§ 9.1.2 The General Conditions are AIA Document A201-2007, General Conditions of the Contract for Construction.

§ 9.1.3 The Supplementary and other Conditions of the Contract:

Document	Title	Date	Pages
----------	-------	------	-------

§ 9.1.4 The Specifications:

(Either list the Specifications here or refer to an exhibit attached to this Agreement.)

Section	Title	Date	Pages
---------	-------	------	-------

§ 9.1.5 The Drawings:

(Either list the Drawings here or refer to an exhibit attached to this Agreement.)

Number	Title	Date
--------	-------	------

§ 9.1.6 The Addenda, if any:

Number	Date	Pages
--------	------	-------

Portions of Addenda relating to bidding requirements are not part of the Contract Documents unless the bidding requirements are also enumerated in this Article 9.

§ 9.1.7 Additional documents, if any, forming part of the Contract Documents:

- .1 AIA Document E201™-2007, Digital Data Protocol Exhibit, if completed by the parties, or the following:
- .2 Other documents, if any, listed below:
(List here any additional documents that are intended to form part of the Contract Documents. AIA Document A201-2007 provides that bidding requirements such as advertisement or invitation to bid, Instructions to Bidders, sample forms and the Contractor's bid are not part of the Contract Documents)

Init.

unless enumerated in this Agreement. They should be listed here only if intended to be part of the Contract Documents.)

ARTICLE 10 INSURANCE AND BONDS

The Contractor shall purchase and maintain insurance and provide bonds as set forth in Article 11 of AIA Document A201–2007.

(State bonding requirements, if any, and limits of liability for insurance required in Article 11 of AIA Document A201–2007.)

Type of insurance or bond	Limit of liability or bond amount (\$0.00)
----------------------------------	---

This Agreement entered into as of the day and year first written above.

OWNER *(Signature)*

CONTRACTOR *(Signature)*

(Printed name and title)

(Printed name and title)

Init.

SECTION 00 52 13 – SUPPLEMENTARY FORM OF AGREEMENT

The following supplements modify the "Standard Form of Agreement Between Owner and Contractor," AIA Document A101, 2007. Where any Article is modified or any Paragraph or Subparagraph is modified or deleted, the unaltered provisions of that Article, Paragraph, or Subparagraph shall remain in effect.

ARTICLE 1 – THE CONTRACT DOCUMENTS

Add the following paragraph 1.1:

- 1.1 The proposed Bidding Documents also include the Rhode Island Judicial Purchasing Rules and Regulations and General Terms and Conditions of Purchase along with any Judicial Purchasing Orders issued for the Project.

END OF SECTION 00 52 13

SECTION 00 61 13 – PERFORMANCE AND PAYMENT BONDS

1. PERFORMANCE AND PAYMENT BONDS

AIA Document A312, Performance and Payment Bond - 2010 Edition, as amended, is included on the following page and is an integral part of the Bidding Documents. Provisions not amended or supplemented remain in full force and effect.

END OF SECTION 00 61 13

AIA[®] Document A312™ – 2010

Performance Bond

CONTRACTOR:
(Name, legal status and address)

SURETY:
(Name, legal status and principal place of business)

OWNER:
(Name, legal status and address)

CONSTRUCTION CONTRACT

Date:
Amount: \$
Description:
(Name and location)

BOND

Date:
(Not earlier than Construction Contract Date)

Amount: \$
Modifications to this Bond: None See Section 16

CONTRACTOR AS PRINCIPAL
Company: *(Corporate Seal)*

SURETY
Company: *(Corporate Seal)*

Signature: _____
Name and
Title:

Signature: _____
Name and
Title:

(Any additional signatures appear on the last page of this Performance Bond.)

(FOR INFORMATION ONLY — Name, address and telephone)

AGENT or BROKER:

OWNER'S REPRESENTATIVE:
(Architect, Engineer or other party:)

ADDITIONS AND DELETIONS:

The author of this document has added information needed for its completion. The author may also have revised the text of the original AIA standard form. An *Additions and Deletions Report* that notes added information as well as revisions to the standard form text is available from the author and should be reviewed. A vertical line in the left margin of this document indicates where the author has added necessary information and where the author has added to or deleted from the original AIA text.

This document has important legal consequences. Consultation with an attorney is encouraged with respect to its completion or modification.

Any singular reference to Contractor, Surety, Owner or other party shall be considered plural where applicable.

§ 1 The Contractor and Surety, jointly and severally, bind themselves, their heirs, executors, administrators, successors and assigns to the Owner for the performance of the Construction Contract, which is incorporated herein by reference.

§ 2 If the Contractor performs the Construction Contract, the Surety and the Contractor shall have no obligation under this Bond, except when applicable to participate in a conference as provided in Section 3.

§ 3 If there is no Owner Default under the Construction Contract, the Surety's obligation under this Bond shall arise after

- .1 the Owner first provides notice to the Contractor and the Surety that the Owner is considering declaring a Contractor Default. Such notice shall indicate whether the Owner is requesting a conference among the Owner, Contractor and Surety to discuss the Contractor's performance. If the Owner does not request a conference, the Surety may, within five (5) business days after receipt of the Owner's notice, request such a conference. If the Surety timely requests a conference, the Owner shall attend. Unless the Owner agrees otherwise, any conference requested under this Section 3.1 shall be held within ten (10) business days of the Surety's receipt of the Owner's notice. If the Owner, the Contractor and the Surety agree, the Contractor shall be allowed a reasonable time to perform the Construction Contract, but such an agreement shall not waive the Owner's right, if any, subsequently to declare a Contractor Default;
- .2 the Owner declares a Contractor Default, terminates the Construction Contract and notifies the Surety; and
- .3 the Owner has agreed to pay the Balance of the Contract Price in accordance with the terms of the Construction Contract to the Surety or to a contractor selected to perform the Construction Contract.

§ 4 Failure on the part of the Owner to comply with the notice requirement in Section 3.1 shall not constitute a failure to comply with a condition precedent to the Surety's obligations, or release the Surety from its obligations, except to the extent the Surety demonstrates actual prejudice.

§ 5 When the Owner has satisfied the conditions of Section 3, the Surety shall promptly and at the Surety's expense take one of the following actions:

§ 5.1 Arrange for the Contractor, with the consent of the Owner, to perform and complete the Construction Contract;

§ 5.2 Undertake to perform and complete the Construction Contract itself, through its agents or independent contractors;

§ 5.3 Obtain bids or negotiated proposals from qualified contractors acceptable to the Owner for a contract for performance and completion of the Construction Contract, arrange for a contract to be prepared for execution by the Owner and a contractor selected with the Owner's concurrence, to be secured with performance and payment bonds executed by a qualified surety equivalent to the bonds issued on the Construction Contract, and pay to the Owner the amount of damages as described in Section 7 in excess of the Balance of the Contract Price incurred by the Owner as a result of the Contractor Default; or

§ 5.4 Waive its right to perform and complete, arrange for completion, or obtain a new contractor and with reasonable promptness under the circumstances:

- .1 After investigation, determine the amount for which it may be liable to the Owner and, as soon as practicable after the amount is determined, make payment to the Owner; or
- .2 Deny liability in whole or in part and notify the Owner, citing the reasons for denial.

§ 6 If the Surety does not proceed as provided in Section 5 with reasonable promptness, the Surety shall be deemed to be in default on this Bond seven days after receipt of an additional written notice from the Owner to the Surety demanding that the Surety perform its obligations under this Bond, and the Owner shall be entitled to enforce any remedy available to the Owner. If the Surety proceeds as provided in Section 5.4, and the Owner refuses the payment or the Surety has denied liability, in whole or in part, without further notice the Owner shall be entitled to enforce any remedy available to the Owner.

§ 7 If the Surety elects to act under Section 5.1, 5.2 or 5.3, then the responsibilities of the Surety to the Owner shall not be greater than those of the Contractor under the Construction Contract, and the responsibilities of the Owner to the Surety shall not be greater than those of the Owner under the Construction Contract. Subject to the commitment by the Owner to pay the Balance of the Contract Price, the Surety is obligated, without duplication, for

- .1 the responsibilities of the Contractor for correction of defective work and completion of the Construction Contract;
- .2 additional legal, design professional and delay costs resulting from the Contractor's Default, and resulting from the actions or failure to act of the Surety under Section 5; and
- .3 liquidated damages, or if no liquidated damages are specified in the Construction Contract, actual damages caused by delayed performance or non-performance of the Contractor.

§ 8 If the Surety elects to act under Section 5.1, 5.3 or 5.4, the Surety's liability is limited to the amount of this Bond.

§ 9 The Surety shall not be liable to the Owner or others for obligations of the Contractor that are unrelated to the Construction Contract, and the Balance of the Contract Price shall not be reduced or set off on account of any such unrelated obligations. No right of action shall accrue on this Bond to any person or entity other than the Owner or its heirs, executors, administrators, successors and assigns.

§ 10 The Surety hereby waives notice of any change, including changes of time, to the Construction Contract or to related subcontracts, purchase orders and other obligations.

§ 11 Any proceeding, legal or equitable, under this Bond may be instituted in any court of competent jurisdiction in the location in which the work or part of the work is located and shall be instituted within two years after a declaration of Contractor Default or within two years after the Contractor ceased working or within two years after the Surety refuses or fails to perform its obligations under this Bond, whichever occurs first. If the provisions of this Paragraph are void or prohibited by law, the minimum period of limitation available to sureties as a defense in the jurisdiction of the suit shall be applicable.

§ 12 Notice to the Surety, the Owner or the Contractor shall be mailed or delivered to the address shown on the page on which their signature appears.

§ 13 When this Bond has been furnished to comply with a statutory or other legal requirement in the location where the construction was to be performed, any provision in this Bond conflicting with said statutory or legal requirement shall be deemed deleted herefrom and provisions conforming to such statutory or other legal requirement shall be deemed incorporated herein. When so furnished, the intent is that this Bond shall be construed as a statutory bond and not as a common law bond.

§ 14 Definitions

§ 14.1 **Balance of the Contract Price.** The total amount payable by the Owner to the Contractor under the Construction Contract after all proper adjustments have been made, including allowance to the Contractor of any amounts received or to be received by the Owner in settlement of insurance or other claims for damages to which the Contractor is entitled, reduced by all valid and proper payments made to or on behalf of the Contractor under the Construction Contract.

§ 14.2 **Construction Contract.** The agreement between the Owner and Contractor identified on the cover page, including all Contract Documents and changes made to the agreement and the Contract Documents.

§ 14.3 **Contractor Default.** Failure of the Contractor, which has not been remedied or waived, to perform or otherwise to comply with a material term of the Construction Contract.

§ 14.4 **Owner Default.** Failure of the Owner, which has not been remedied or waived, to pay the Contractor as required under the Construction Contract or to perform and complete or comply with the other material terms of the Construction Contract.

§ 14.5 **Contract Documents.** All the documents that comprise the agreement between the Owner and Contractor.

Init.

§ 15 If this Bond is issued for an agreement between a Contractor and subcontractor, the term Contractor in this Bond shall be deemed to be Subcontractor and the term Owner shall be deemed to be Contractor.

§ 16 Modifications to this bond are as follows:

(Space is provided below for additional signatures of added parties, other than those appearing on the cover page.)

CONTRACTOR AS PRINCIPAL

Company: _____
(Corporate Seal)

Signature: _____

Name and Title: _____

Address: _____

SURETY

Company: _____
(Corporate Seal)

Signature: _____

Name and Title: _____

Address: _____

Init.

User Notes:

(1165649729)



AIA[®] Document A312[™] – 2010

Payment Bond

CONTRACTOR:
(Name, legal status and address)

SURETY:
(Name, legal status and principal place of business)

OWNER:
(Name, legal status and address)

CONSTRUCTION CONTRACT

Date:
Amount: \$
Description:
(Name and location)

BOND

Date:
(Not earlier than Construction Contract Date)

Amount: \$
Modifications to this Bond: None See Section 18

CONTRACTOR AS PRINCIPAL
Company: *(Corporate Seal)*

SURETY
Company: *(Corporate Seal)*

Signature: _____
Name and
Title:

Signature: _____
Name and
Title:

(Any additional signatures appear on the last page of this Payment Bond.)

(FOR INFORMATION ONLY — Name, address and telephone)

AGENT or BROKER:

OWNER'S REPRESENTATIVE:
(Architect, Engineer or other party:)

ADDITIONS AND DELETIONS:

The author of this document has added information needed for its completion. The author may also have revised the text of the original AIA standard form. An *Additions and Deletions Report* that notes added information as well as revisions to the standard form text is available from the author and should be reviewed. A vertical line in the left margin of this document indicates where the author has added necessary information and where the author has added to or deleted from the original AIA text.

This document has important legal consequences. Consultation with an attorney is encouraged with respect to its completion or modification.

Any singular reference to Contractor, Surety, Owner or other party shall be considered plural where applicable.

Init.

§ 1 The Contractor and Surety, jointly and severally, bind themselves, their heirs, executors, administrators, successors and assigns to the Owner to pay for labor, materials and equipment furnished for use in the performance of the Construction Contract, which is incorporated herein by reference, subject to the following terms.

§ 2 If the Contractor promptly makes payment of all sums due to Claimants, and defends, indemnifies and holds harmless the Owner from claims, demands, liens or suits by any person or entity seeking payment for labor, materials or equipment furnished for use in the performance of the Construction Contract, then the Surety and the Contractor shall have no obligation under this Bond.

§ 3 If there is no Owner Default under the Construction Contract, the Surety's obligation to the Owner under this Bond shall arise after the Owner has promptly notified the Contractor and the Surety (at the address described in Section 13) of claims, demands, liens or suits against the Owner or the Owner's property by any person or entity seeking payment for labor, materials or equipment furnished for use in the performance of the Construction Contract and tendered defense of such claims, demands, liens or suits to the Contractor and the Surety.

§ 4 When the Owner has satisfied the conditions in Section 3, the Surety shall promptly and at the Surety's expense defend, indemnify and hold harmless the Owner against a duly tendered claim, demand, lien or suit.

§ 5 The Surety's obligations to a Claimant under this Bond shall arise after the following:

§ 5.1 Claimants, who do not have a direct contract with the Contractor,

- .1 have furnished a written notice of non-payment to the Contractor, stating with substantial accuracy the amount claimed and the name of the party to whom the materials were, or equipment was, furnished or supplied or for whom the labor was done or performed, within ninety (90) days after having last performed labor or last furnished materials or equipment included in the Claim; and
- .2 have sent a Claim to the Surety (at the address described in Section 13).

§ 5.2 Claimants, who are employed by or have a direct contract with the Contractor, have sent a Claim to the Surety (at the address described in Section 13).

§ 6 If a notice of non-payment required by Section 5.1.1 is given by the Owner to the Contractor, that is sufficient to satisfy a Claimant's obligation to furnish a written notice of non-payment under Section 5.1.1.

§ 7 When a Claimant has satisfied the conditions of Sections 5.1 or 5.2, whichever is applicable, the Surety shall promptly and at the Surety's expense take the following actions:

§ 7.1 Send an answer to the Claimant, with a copy to the Owner, within sixty (60) days after receipt of the Claim, stating the amounts that are undisputed and the basis for challenging any amounts that are disputed; and

§ 7.2 Pay or arrange for payment of any undisputed amounts.

§ 7.3 The Surety's failure to discharge its obligations under Section 7.1 or Section 7.2 shall not be deemed to constitute a waiver of defenses the Surety or Contractor may have or acquire as to a Claim, except as to undisputed amounts for which the Surety and Claimant have reached agreement. If, however, the Surety fails to discharge its obligations under Section 7.1 or Section 7.2, the Surety shall indemnify the Claimant for the reasonable attorney's fees the Claimant incurs thereafter to recover any sums found to be due and owing to the Claimant.

§ 8 The Surety's total obligation shall not exceed the amount of this Bond, plus the amount of reasonable attorney's fees provided under Section 7.3, and the amount of this Bond shall be credited for any payments made in good faith by the Surety.

§ 9 Amounts owed by the Owner to the Contractor under the Construction Contract shall be used for the performance of the Construction Contract and to satisfy claims, if any, under any construction performance bond. By the Contractor furnishing and the Owner accepting this Bond, they agree that all funds earned by the Contractor in the performance of the Construction Contract are dedicated to satisfy obligations of the Contractor and Surety under this Bond, subject to the Owner's priority to use the funds for the completion of the work.

§ 10 The Surety shall not be liable to the Owner, Claimants or others for obligations of the Contractor that are unrelated to the Construction Contract. The Owner shall not be liable for the payment of any costs or expenses of any Claimant under this Bond, and shall have under this Bond no obligation to make payments to, or give notice on behalf of, Claimants or otherwise have any obligations to Claimants under this Bond.

§ 11 The Surety hereby waives notice of any change, including changes of time, to the Construction Contract or to related subcontracts, purchase orders and other obligations.

§ 12 No suit or action shall be commenced by a Claimant under this Bond other than in a court of competent jurisdiction in the state in which the project that is the subject of the Construction Contract is located or after the expiration of one year from the date (1) on which the Claimant sent a Claim to the Surety pursuant to Section 5.1.2 or 5.2, or (2) on which the last labor or service was performed by anyone or the last materials or equipment were furnished by anyone under the Construction Contract, whichever of (1) or (2) first occurs. If the provisions of this Paragraph are void or prohibited by law, the minimum period of limitation available to sureties as a defense in the jurisdiction of the suit shall be applicable.

§ 13 Notice and Claims to the Surety, the Owner or the Contractor shall be mailed or delivered to the address shown on the page on which their signature appears. Actual receipt of notice or Claims, however accomplished, shall be sufficient compliance as of the date received.

§ 14 When this Bond has been furnished to comply with a statutory or other legal requirement in the location where the construction was to be performed, any provision in this Bond conflicting with said statutory or legal requirement shall be deemed deleted herefrom and provisions conforming to such statutory or other legal requirement shall be deemed incorporated herein. When so furnished, the intent is that this Bond shall be construed as a statutory bond and not as a common law bond.

§ 15 Upon request by any person or entity appearing to be a potential beneficiary of this Bond, the Contractor and Owner shall promptly furnish a copy of this Bond or shall permit a copy to be made.

§ 16 Definitions

§ 16.1 Claim. A written statement by the Claimant including at a minimum:

- .1 the name of the Claimant;
- .2 the name of the person for whom the labor was done, or materials or equipment furnished;
- .3 a copy of the agreement or purchase order pursuant to which labor, materials or equipment was furnished for use in the performance of the Construction Contract;
- .4 a brief description of the labor, materials or equipment furnished;
- .5 the date on which the Claimant last performed labor or last furnished materials or equipment for use in the performance of the Construction Contract;
- .6 the total amount earned by the Claimant for labor, materials or equipment furnished as of the date of the Claim;
- .7 the total amount of previous payments received by the Claimant; and
- .8 the total amount due and unpaid to the Claimant for labor, materials or equipment furnished as of the date of the Claim.

§ 16.2 Claimant. An individual or entity having a direct contract with the Contractor or with a subcontractor of the Contractor to furnish labor, materials or equipment for use in the performance of the Construction Contract. The term Claimant also includes any individual or entity that has rightfully asserted a claim under an applicable mechanic's lien or similar statute against the real property upon which the Project is located. The intent of this Bond shall be to include without limitation in the terms "labor, materials or equipment" that part of water, gas, power, light, heat, oil, gasoline, telephone service or rental equipment used in the Construction Contract, architectural and engineering services required for performance of the work of the Contractor and the Contractor's subcontractors, and all other items for which a mechanic's lien may be asserted in the jurisdiction where the labor, materials or equipment were furnished.

§ 16.3 Construction Contract. The agreement between the Owner and Contractor identified on the cover page, including all Contract Documents and all changes made to the agreement and the Contract Documents.

§ 16.4 **Owner Default.** Failure of the Owner, which has not been remedied or waived, to pay the Contractor as required under the Construction Contract or to perform and complete or comply with the other material terms of the Construction Contract.

§ 16.5 **Contract Documents.** All the documents that comprise the agreement between the Owner and Contractor.

§ 17 If this Bond is issued for an agreement between a Contractor and subcontractor, the term Contractor in this Bond shall be deemed to be Subcontractor and the term Owner shall be deemed to be Contractor.

§ 18 Modifications to this bond are as follows:

(Space is provided below for additional signatures of added parties, other than those appearing on the cover page.)

CONTRACTOR AS PRINCIPAL

Company: _____
(Corporate Seal)

SURETY

Company: _____
(Corporate Seal)

Signature: _____
Name and Title: _____
Address: _____

Signature: _____
Name and Title: _____
Address: _____

Init.

SECTION 00 72 13 – GENERAL CONDITIONS

1. GENERAL CONDITIONS

AIA Document A201, General Conditions of the Contract for Construction – 2007 Edition, as amended, is included on the following page and is an integral part of the Bidding Documents. Provisions not amended or supplemented remain in full force and effect.

END OF SECTION 00 72 13

AIA[®] Document A201[™] – 2007

General Conditions of the Contract for Construction

for the following PROJECT:
(Name and location or address)

THE OWNER:
(Name, legal status and address)

THE ARCHITECT:
(Name, legal status and address)

TABLE OF ARTICLES

- 1 GENERAL PROVISIONS
- 2 OWNER
- 3 CONTRACTOR
- 4 ARCHITECT
- 5 SUBCONTRACTORS
- 6 CONSTRUCTION BY OWNER OR BY SEPARATE CONTRACTORS
- 7 CHANGES IN THE WORK
- 8 TIME
- 9 PAYMENTS AND COMPLETION
- 10 PROTECTION OF PERSONS AND PROPERTY
- 11 INSURANCE AND BONDS
- 12 UNCOVERING AND CORRECTION OF WORK
- 13 MISCELLANEOUS PROVISIONS
- 14 TERMINATION OR SUSPENSION OF THE CONTRACT
- 15 CLAIMS AND DISPUTES

ADDITIONS AND DELETIONS:

The author of this document has added information needed for its completion. The author may also have revised the text of the original AIA standard form. An *Additions and Deletions Report* that notes added information as well as revisions to the standard form text is available from the author and should be reviewed. A vertical line in the left margin of this document indicates where the author has added necessary information and where the author has added to or deleted from the original AIA text.

This document has important legal consequences. Consultation with an attorney is encouraged with respect to its completion or modification.

INDEX

(Topics and numbers in bold are section headings.)

Acceptance of Nonconforming Work

9.6.6, 9.9.3, **12.3**

Acceptance of Work

9.6.6, 9.8.2, 9.9.3, 9.10.1, 9.10.3, 12.3

Access to Work

3.16, 6.2.1, 12.1

Accident Prevention

10

Acts and Omissions

3.2, 3.3.2, 3.12.8, 3.18, 4.2.3, 8.3.1, 9.5.1, 10.2.5, 10.2.8, 13.4.2, 13.7, 14.1, 15.2

Addenda

1.1.1, 3.11

Additional Costs, Claims for

3.7.4, 3.7.5, 6.1.1, 7.3.7.5, 10.3, 15.1.4

Additional Inspections and Testing

9.4.2, 9.8.3, 12.2.1, **13.5**

Additional Insured

11.1.4

Additional Time, Claims for

3.2.4, 3.7.4, 3.7.5, 3.10.2, 8.3.2, **15.1.5**

Administration of the Contract

3.1.3, **4.2**, 9.4, 9.5

Advertisement or Invitation to Bid

1.1.1

Aesthetic Effect

4.2.13

Allowances

3.8, 7.3.8

All-risk Insurance

11.3.1, 11.3.1.1

Applications for Payment

4.2.5, 7.3.9, 9.2, **9.3**, 9.4, 9.5.1, 9.6.3, 9.7, 9.10, 11.1.3

Approvals

2.1.1, 2.2.2, 2.4, 3.1.3, 3.10.2, 3.12.8, 3.12.9, 3.12.10, 4.2.7, 9.3.2, 13.5.1

Arbitration

8.3.1, 11.3.10, 13.1, 15.3.2, **15.4**

ARCHITECT

4

Architect, Definition of

4.1.1

Architect, Extent of Authority

2.4, 3.12.7, 4.1, 4.2, 5.2, 6.3, 7.1.2, 7.3.7, 7.4, 9.2, 9.3.1, 9.4, 9.5, 9.6.3, 9.8, 9.10.1, 9.10.3, 12.1, 12.2.1, 13.5.1, 13.5.2, 14.2.2, 14.2.4, 15.1.3, 15.2.1

Architect, Limitations of Authority and Responsibility

2.1.1, 3.12.4, 3.12.8, 3.12.10, 4.1.2, 4.2.1, 4.2.2, 4.2.3, 4.2.6, 4.2.7, 4.2.10, 4.2.12, 4.2.13, 5.2.1, 7.4, 9.4.2, 9.5.3, 9.6.4, 15.1.3, 15.2

Architect's Additional Services and Expenses

2.4, 11.3.1.1, 12.2.1, 13.5.2, 13.5.3, 14.2.4

Architect's Administration of the Contract

3.1.3, 4.2, 3.7.4, 15.2, 9.4.1, 9.5

Architect's Approvals

2.4, 3.1.3, 3.5, 3.10.2, 4.2.7

Architect's Authority to Reject Work

3.5, 4.2.6, 12.1.2, 12.2.1

Architect's Copyright

1.1.7, 1.5

Architect's Decisions

3.7.4, 4.2.6, 4.2.7, 4.2.11, 4.2.12, 4.2.13, 4.2.14, 6.3, 7.3.7, 7.3.9, 8.1.3, 8.3.1, 9.2, 9.4.1, 9.5, 9.8.4, 9.9.1, 13.5.2, 15.2, 15.3

Architect's Inspections

3.7.4, 4.2.2, 4.2.9, 9.4.2, 9.8.3, 9.9.2, 9.10.1, 13.5

Architect's Instructions

3.2.4, 3.3.1, 4.2.6, 4.2.7, 13.5.2

Architect's Interpretations

4.2.11, 4.2.12

Architect's Project Representative

4.2.10

Architect's Relationship with Contractor

1.1.2, 1.5, 3.1.3, 3.2.2, 3.2.3, 3.2.4, 3.3.1, 3.4.2, 3.5, 3.7.4, 3.7.5, 3.9.2, 3.9.3, 3.10, 3.11, 3.12, 3.16, 3.18, 4.1.2, 4.1.3, 4.2, 5.2, 6.2.2, 7, 8.3.1, 9.2, 9.3, 9.4, 9.5, 9.7, 9.8, 9.9, 10.2.6, 10.3, 11.3.7, 12, 13.4.2, 13.5, 15.2

Architect's Relationship with Subcontractors

1.1.2, 4.2.3, 4.2.4, 4.2.6, 9.6.3, 9.6.4, 11.3.7

Architect's Representations

9.4.2, 9.5.1, 9.10.1

Architect's Site Visits

3.7.4, 4.2.2, 4.2.9, 9.4.2, 9.5.1, 9.9.2, 9.10.1, 13.5

Asbestos

10.3.1

Attorneys' Fees

3.18.1, 9.10.2, 10.3.3

Award of Separate Contracts

6.1.1, 6.1.2

Award of Subcontracts and Other Contracts for Portions of the Work

5.2

Basic Definitions

1.1

Bidding Requirements

1.1.1, 5.2.1, 11.4.1

Binding Dispute Resolution

9.7, 11.3.9, 11.3.10, 13.1, 15.2.5, 15.2.6.1, 15.3.1, 15.3.2, 15.4.1

Boiler and Machinery Insurance

11.3.2

Bonds, Lien

7.3.7.4, 9.10.2, 9.10.3

Bonds, Performance, and Payment

7.3.7.4, 9.6.7, 9.10.3, 11.3.9, **11.4**

Building Permit

3.7.1

Init.

AIA Document A201™ – 2007. Copyright © 1911, 1915, 1918, 1925, 1937, 1951, 1958, 1961, 1963, 1966, 1970, 1976, 1987, 1997 and 2007 by The American Institute of Architects. All rights reserved. **WARNING: This AIA® Document is protected by U.S. Copyright Law and International Treaties. Unauthorized reproduction or distribution of this AIA® Document, or any portion of it, may result in severe civil and criminal penalties, and will be prosecuted to the maximum extent possible under the law.** This document was produced by AIA software at 14:46:57 on 05/27/2016 under Order No.9505439256_1 which expires on 03/28/2017, and is not for resale.

User Notes:

(728182638)

Capitalization

1.3

Certificate of Substantial Completion

9.8.3, 9.8.4, 9.8.5

Certificates for Payment

4.2.1, 4.2.5, 4.2.9, 9.3.3, 9.4, 9.5, 9.6.1, 9.6.6, 9.7,

9.10.1, 9.10.3, 14.1.1.3, 14.2.4, 15.1.3

Certificates of Inspection, Testing or Approval

13.5.4

Certificates of Insurance

9.10.2, 11.1.3

Change Orders

1.1.1, 2.4, 3.4.2, 3.7.4, 3.8.2.3, 3.11, 3.12.8, 4.2.8,

5.2.3, 7.1.2, 7.1.3, 7.2, 7.3.2, 7.3.6, 7.3.9, 7.3.10, 8.3.1,

9.3.1.1, 9.10.3, 10.3.2, 11.3.1.2, 11.3.4, 11.3.9, 12.1.2,

15.1.3

Change Orders, Definition of

7.2.1

CHANGES IN THE WORK

2.2.1, 3.11, 4.2.8, 7, 7.2.1, 7.3.1, 7.4, 8.3.1, 9.3.1.1,

11.3.9

Claims, Definition of

15.1.1

CLAIMS AND DISPUTES

3.2.4, 6.1.1, 6.3, 7.3.9, 9.3.3, 9.10.4, 10.3.3, 15, 15.4

Claims and Timely Assertion of Claims

15.4.1

Claims for Additional Cost

3.2.4, 3.7.4, 6.1.1, 7.3.9, 10.3.2, 15.1.4

Claims for Additional Time

3.2.4, 3.7.4, 6.1.1, 8.3.2, 10.3.2, 15.1.5

Concealed or Unknown Conditions, Claims for

3.7.4

Claims for Damages

3.2.4, 3.18, 6.1.1, 8.3.3, 9.5.1, 9.6.7, 10.3.3, 11.1.1,

11.3.5, 11.3.7, 14.1.3, 14.2.4, 15.1.6

Claims Subject to Arbitration

15.3.1, 15.4.1

Cleaning Up

3.15, 6.3

Commencement of the Work, Conditions Relating to

2.2.1, 3.2.2, 3.4.1, 3.7.1, 3.10.1, 3.12.6, 5.2.1, 5.2.3,

6.2.2, 8.1.2, 8.2.2, 8.3.1, 11.1, 11.3.1, 11.3.6, 11.4.1,

15.1.4

Commencement of the Work, Definition of

8.1.2

Communications Facilitating Contract

Administration

3.9.1, 4.2.4

Completion, Conditions Relating to

3.4.1, 3.11, 3.15, 4.2.2, 4.2.9, 8.2, 9.4.2, 9.8, 9.9.1,

9.10, 12.2, 13.7, 14.1.2

COMPLETION, PAYMENTS AND

9

Completion, Substantial

4.2.9, 8.1.1, 8.1.3, 8.2.3, 9.4.2, 9.8, 9.9.1, 9.10.3, 12.2,

13.7

Compliance with Laws

1.6, 3.2.3, 3.6, 3.7, 3.12.10, 3.13, 4.1.1, 9.6.4, 10.2.2,

11.1, 11.3, 13.1, 13.4, 13.5.1, 13.5.2, 13.6, 14.1.1,

14.2.1.3, 15.2.8, 15.4.2, 15.4.3

Concealed or Unknown Conditions

3.7.4, 4.2.8, 8.3.1, 10.3

Conditions of the Contract

1.1.1, 6.1.1, 6.1.4

Consent, Written

3.4.2, 3.7.4, 3.12.8, 3.14.2, 4.1.2, 9.3.2, 9.8.5, 9.9.1,

9.10.2, 9.10.3, 11.3.1, 13.2, 13.4.2, 15.4.4.2

Consolidation or Joinder

15.4.4

CONSTRUCTION BY OWNER OR BY

SEPARATE CONTRACTORS

1.1.4, 6

Construction Change Directive, Definition of

7.3.1

Construction Change Directives

1.1.1, 3.4.2, 3.12.8, 4.2.8, 7.1.1, 7.1.2, 7.1.3, 7.3,

9.3.1.1

Construction Schedules, Contractor's

3.10, 3.12.1, 3.12.2, 6.1.3, 15.1.5.2

Contingent Assignment of Subcontracts

5.4, 14.2.2.2

Continuing Contract Performance

15.1.3

Contract, Definition of

1.1.2

CONTRACT, TERMINATION OR

SUSPENSION OF THE

5.4.1.1, 11.3.9, 14

Contract Administration

3.1.3, 4, 9.4, 9.5

Contract Award and Execution, Conditions Relating

to

3.7.1, 3.10, 5.2, 6.1, 11.1.3, 11.3.6, 11.4.1

Contract Documents, Copies Furnished and Use of

1.5.2, 2.2.5, 5.3

Contract Documents, Definition of

1.1.1

Contract Sum

3.7.4, 3.8, 5.2.3, 7.2, 7.3, 7.4, 9.1, 9.4.2, 9.5.1.4, 9.6.7,

9.7, 10.3.2, 11.3.1, 14.2.4, 14.3.2, 15.1.4, 15.2.5

Contract Sum, Definition of

9.1

Contract Time

3.7.4, 3.7.5, 3.10.2, 5.2.3, 7.2.1.3, 7.3.1, 7.3.5, 7.4,

8.1.1, 8.2.1, 8.3.1, 9.5.1, 9.7, 10.3.2, 12.1.1, 14.3.2,

15.1.5.1, 15.2.5

Contract Time, Definition of

8.1.1

CONTRACTOR

3

Contractor, Definition of

3.1, 6.1.2

Contractor's Construction Schedules

3.10, 3.12.1, 3.12.2, 6.1.3, 15.1.5.2

Contractor's Employees

3.3.2, 3.4.3, 3.8.1, 3.9, 3.18.2, 4.2.3, 4.2.6, 10.2, 10.3, 11.1.1, 11.3.7, 14.1, 14.2.1.1

Contractor's Liability Insurance

11.1

Contractor's Relationship with Separate Contractors and Owner's Forces

3.12.5, 3.14.2, 4.2.4, 6, 11.3.7, 12.1.2, 12.2.4

Contractor's Relationship with Subcontractors

1.2.2, 3.3.2, 3.18.1, 3.18.2, 5, 9.6.2, 9.6.7, 9.10.2, 11.3.1.2, 11.3.7, 11.3.8

Contractor's Relationship with the Architect

1.1.2, 1.5, 3.1.3, 3.2.2, 3.2.3, 3.2.4, 3.3.1, 3.4.2, 3.5, 3.7.4, 3.10, 3.11, 3.12, 3.16, 3.18, 4.1.3, 4.2, 5.2, 6.2.2, 7, 8.3.1, 9.2, 9.3, 9.4, 9.5, 9.7, 9.8, 9.9, 10.2.6, 10.3, 11.3.7, 12, 13.5, 15.1.2, 15.2.1

Contractor's Representations

3.2.1, 3.2.2, 3.5, 3.12.6, 6.2.2, 8.2.1, 9.3.3, 9.8.2

Contractor's Responsibility for Those Performing the Work

3.3.2, 3.18, 5.3, 6.1.3, 6.2, 9.5.1, 10.2.8

Contractor's Review of Contract Documents

3.2

Contractor's Right to Stop the Work

9.7

Contractor's Right to Terminate the Contract

14.1, 15.1.6

Contractor's Submittals

3.10, 3.11, 3.12.4, 4.2.7, 5.2.1, 5.2.3, 9.2, 9.3, 9.8.2, 9.8.3, 9.9.1, 9.10.2, 9.10.3, 11.1.3, 11.4.2

Contractor's Superintendent

3.9, 10.2.6

Contractor's Supervision and Construction

Procedures

1.2.2, 3.3, 3.4, 3.12.10, 4.2.2, 4.2.7, 6.1.3, 6.2.4, 7.1.3, 7.3.5, 7.3.7, 8.2, 10, 12, 14, 15.1.3

Contractual Liability Insurance

11.1.1.8, 11.2

Coordination and Correlation

1.2, 3.2.1, 3.3.1, 3.10, 3.12.6, 6.1.3, 6.2.1

Copies Furnished of Drawings and Specifications

1.5, 2.2.5, 3.11

Copyrights

1.5, 3.17

Correction of Work

2.3, 2.4, 3.7.3, 9.4.2, 9.8.2, 9.8.3, 9.9.1, 12.1.2, 12.2

Correlation and Intent of the Contract Documents

1.2

Cost, Definition of

7.3.7

Costs

2.4, 3.2.4, 3.7.3, 3.8.2, 3.15.2, 5.4.2, 6.1.1, 6.2.3, 7.3.3.3, 7.3.7, 7.3.8, 7.3.9, 9.10.2, 10.3.2, 10.3.6, 11.3, 12.1.2, 12.2.1, 12.2.4, 13.5, 14

Cutting and Patching

3.14, 6.2.5

Damage to Construction of Owner or Separate Contractors

3.14.2, 6.2.4, 10.2.1.2, 10.2.5, 10.4, 11.1.1, 11.3, 12.2.4

Damage to the Work

3.14.2, 9.9.1, 10.2.1.2, 10.2.5, 10.4, 11.3.1, 12.2.4

Damages, Claims for

3.2.4, 3.18, 6.1.1, 8.3.3, 9.5.1, 9.6.7, 10.3.3, 11.1.1, 11.3.5, 11.3.7, 14.1.3, 14.2.4, 15.1.6

Damages for Delay

6.1.1, 8.3.3, 9.5.1.6, 9.7, 10.3.2

Date of Commencement of the Work, Definition of

8.1.2

Date of Substantial Completion, Definition of

8.1.3

Day, Definition of

8.1.4

Decisions of the Architect

3.7.4, 4.2.6, 4.2.7, 4.2.11, 4.2.12, 4.2.13, 15.2, 6.3, 7.3.7, 7.3.9, 8.1.3, 8.3.1, 9.2, 9.4, 9.5.1, 9.8.4, 9.9.1, 13.5.2, 14.2.2, 14.2.4, 15.1, 15.2

Decisions to Withhold Certification

9.4.1, 9.5, 9.7, 14.1.1.3

Defective or Nonconforming Work, Acceptance, Rejection and Correction of

2.3, 2.4, 3.5, 4.2.6, 6.2.5, 9.5.1, 9.5.2, 9.6.6, 9.8.2, 9.9.3, 9.10.4, 12.2.1

Definitions

1.1, 2.1.1, 3.1.1, 3.5, 3.12.1, 3.12.2, 3.12.3, 4.1.1, 15.1.1, 5.1, 6.1.2, 7.2.1, 7.3.1, 8.1, 9.1, 9.8.1

Delays and Extensions of Time

3.2, 3.7.4, 5.2.3, 7.2.1, 7.3.1, 7.4, 8.3, 9.5.1, 9.7, 10.3.2, 10.4, 14.3.2, 15.1.5, 15.2.5

Disputes

6.3, 7.3.9, 15.1, 15.2

Documents and Samples at the Site

3.11

Drawings, Definition of

1.1.5

Drawings and Specifications, Use and Ownership of

3.11

Effective Date of Insurance

8.2.2, 11.1.2

Emergencies

10.4, 14.1.1.2, 15.1.4

Employees, Contractor's

3.3.2, 3.4.3, 3.8.1, 3.9, 3.18.2, 4.2.3, 4.2.6, 10.2, 10.3.3, 11.1.1, 11.3.7, 14.1, 14.2.1.1

Equipment, Labor, Materials or

1.1.3, 1.1.6, 3.4, 3.5, 3.8.2, 3.8.3, 3.12, 3.13, 3.15.1, 4.2.6, 4.2.7, 5.2.1, 6.2.1, 7.3.7, 9.3.2, 9.3.3, 9.5.1.3, 9.10.2, 10.2.1, 10.2.4, 14.2.1.1, 14.2.1.2

Init.

AIA Document A201™ – 2007. Copyright © 1911, 1915, 1918, 1925, 1937, 1951, 1958, 1961, 1963, 1966, 1970, 1976, 1987, 1997 and 2007 by The American Institute of Architects. All rights reserved. **WARNING: This AIA® Document is protected by U.S. Copyright Law and International Treaties. Unauthorized reproduction or distribution of this AIA® Document, or any portion of it, may result in severe civil and criminal penalties, and will be prosecuted to the maximum extent possible under the law.** This document was produced by AIA software at 14:46:57 on 05/27/2016 under Order No.9505439256_1 which expires on 03/28/2017, and is not for resale.

User Notes:

(728182638)

Execution and Progress of the Work
 1.1.3, 1.2.1, 1.2.2, 2.2.3, 2.2.5, 3.1, 3.3.1, 3.4.1, 3.5,
 3.7.1, 3.10.1, 3.12, 3.14, 4.2, 6.2.2, 7.1.3, 7.3.5, 8.2,
 9.5.1, 9.9.1, 10.2, 10.3, 12.2, 14.2, 14.3.1, 15.1.3
 Extensions of Time
 3.2.4, 3.7.4, 5.2.3, 7.2.1, 7.3, 7.4, 9.5.1, 9.7, 10.3.2,
 10.4, 14.3, 15.1.5, 15.2.5
Failure of Payment
 9.5.1.3, 9.7, 9.10.2, 13.6, 14.1.1.3, 14.2.1.2
 Faulty Work
 (See Defective or Nonconforming Work)
Final Completion and Final Payment
 4.2.1, 4.2.9, 9.8.2, 9.10, 11.1.2, 11.1.3, 11.3.1, 11.3.5,
 12.3, 14.2.4, 14.4.3
 Financial Arrangements, Owner's
 2.2.1, 13.2.2, 14.1.1.4
 Fire and Extended Coverage Insurance
 11.3.1.1
GENERAL PROVISIONS
1
Governing Law
13.1
 Guarantees (See Warranty)
Hazardous Materials
 10.2.4, 10.3
 Identification of Subcontractors and Suppliers
 5.2.1
Indemnification
 3.17, 3.18, 9.10.2, 10.3.3, 10.3.5, 10.3.6, 11.3.1.2,
 11.3.7
Information and Services Required of the Owner
 2.1.2, 2.2, 3.2.2, 3.12.4, 3.12.10, 6.1.3, 6.1.4, 6.2.5,
 9.6.1, 9.6.4, 9.9.2, 9.10.3, 10.3.3, 11.2, 11.4, 13.5.1,
 13.5.2, 14.1.1.4, 14.1.4, 15.1.3
Initial Decision
15.2
Initial Decision Maker, Definition of
 1.1.8
 Initial Decision Maker, Decisions
 14.2.2, 14.2.4, 15.2.1, 15.2.2, 15.2.3, 15.2.4, 15.2.5
 Initial Decision Maker, Extent of Authority
 14.2.2, 14.2.4, 15.1.3, 15.2.1, 15.2.2, 15.2.3, 15.2.4,
 15.2.5
Injury or Damage to Person or Property
10.2.8, 10.4
 Inspections
 3.1.3, 3.3.3, 3.7.1, 4.2.2, 4.2.6, 4.2.9, 9.4.2, 9.8.3,
 9.9.2, 9.10.1, 12.2.1, 13.5
 Instructions to Bidders
 1.1.1
 Instructions to the Contractor
 3.2.4, 3.3.1, 3.8.1, 5.2.1, 7, 8.2.2, 12, 13.5.2
Instruments of Service, Definition of
1.1.7
 Insurance
 3.18.1, 6.1.1, 7.3.7, 9.3.2, 9.8.4, 9.9.1, 9.10.2, 11

Insurance, Boiler and Machinery
11.3.2
Insurance, Contractor's Liability
11.1
 Insurance, Effective Date of
 8.2.2, 11.1.2
Insurance, Loss of Use
11.3.3
Insurance, Owner's Liability
11.2
Insurance, Property
 10.2.5, 11.3
 Insurance, Stored Materials
 9.3.2
INSURANCE AND BONDS
11
 Insurance Companies, Consent to Partial Occupancy
 9.9.1
 Intent of the Contract Documents
 1.2.1, 4.2.7, 4.2.12, 4.2.13, 7.4
Interest
13.6
Interpretation
 1.2.3, 1.4, 4.1.1, 5.1, 6.1.2, 15.1.1
 Interpretations, Written
 4.2.11, 4.2.12, 15.1.4
 Judgment on Final Award
 15.4.2
Labor and Materials, Equipment
 1.1.3, 1.1.6, 3.4, 3.5, 3.8.2, 3.8.3, 3.12, 3.13, 3.15.1,
 4.2.6, 4.2.7, 5.2.1, 6.2.1, 7.3.7, 9.3.2, 9.3.3, 9.5.1.3,
 9.10.2, 10.2.1, 10.2.4, 14.2.1.1, 14.2.1.2
 Labor Disputes
 8.3.1
 Laws and Regulations
 1.5, 3.2.3, 3.6, 3.7, 3.12.10, 3.13, 4.1.1, 9.6.4, 9.9.1,
 10.2.2, 11.1.1, 11.3, 13.1, 13.4, 13.5.1, 13.5.2, 13.6,
 14, 15.2.8, 15.4
 Liens
 2.1.2, 9.3.3, 9.10.2, 9.10.4, 15.2.8
 Limitations, Statutes of
 12.2.5, 13.7, 15.4.1.1
 Limitations of Liability
 2.3, 3.2.2, 3.5, 3.12.10, 3.17, 3.18.1, 4.2.6, 4.2.7,
 4.2.12, 6.2.2, 9.4.2, 9.6.4, 9.6.7, 10.2.5, 10.3.3, 11.1.2,
 11.2, 11.3.7, 12.2.5, 13.4.2
 Limitations of Time
 2.1.2, 2.2, 2.4, 3.2.2, 3.10, 3.11, 3.12.5, 3.15.1, 4.2.7,
 5.2, 5.3, 5.4.1, 6.2.4, 7.3, 7.4, 8.2, 9.2, 9.3.1, 9.3.3,
 9.4.1, 9.5, 9.6, 9.7, 9.8, 9.9, 9.10, 11.1.3, 11.3.1.5,
 11.3.6, 11.3.10, 12.2, 13.5, 13.7, 14, 15
Loss of Use Insurance
11.3.3
 Material Suppliers
 1.5, 3.12.1, 4.2.4, 4.2.6, 5.2.1, 9.3, 9.4.2, 9.6, 9.10.5
Materials, Hazardous
10.2.4, 10.3

Materials, Labor, Equipment and
 1.1.3, 1.1.6, 1.5.1, 3.4.1, 3.5, 3.8.2, 3.8.3, 3.12, 3.13,
 3.15.1, 4.2.6, 4.2.7, 5.2.1, 6.2.1, 7.3.7, 9.3.2, 9.3.3,
 9.5.1.3, 9.10.2, 10.2.1.2, 10.2.4, 14.2.1.1, 14.2.1.2
 Means, Methods, Techniques, Sequences and
 Procedures of Construction
 3.3.1, 3.12.10, 4.2.2, 4.2.7, 9.4.2
 Mechanic's Lien
 2.1.2, 15.2.8
Mediation
 8.3.1, 10.3.5, 10.3.6, 15.2.1, 15.2.5, 15.2.6, **15.3**,
 15.4.1
Minor Changes in the Work
 1.1.1, 3.12.8, 4.2.8, 7.1, 7.4
MISCELLANEOUS PROVISIONS
13
Modifications, Definition of
1.1.1
 Modifications to the Contract
 1.1.1, 1.1.2, 3.11, 4.1.2, 4.2.1, 5.2.3, 7, 8.3.1, 9.7,
 10.3.2, 11.3.1
Mutual Responsibility
6.2
Nonconforming Work, Acceptance of
 9.6.6, 9.9.3, **12.3**
 Nonconforming Work, Rejection and Correction of
 2.3, 2.4, 3.5, 4.2.6, 6.2.4, 9.5.1, 9.8.2, 9.9.3, 9.10.4,
 12.2.1
 Notice
 2.2.1, 2.3, 2.4, 3.2.4, 3.3.1, 3.7.2, 3.12.9, 5.2.1, 9.7,
 9.10, 10.2.2, 11.1.3, 12.2.2.1, 13.3, 13.5.1, 13.5.2,
 14.1, 14.2, 15.2.8, 15.4.1
Notice, Written
 2.3, 2.4, 3.3.1, 3.9.2, 3.12.9, 3.12.10, 5.2.1, 9.7, 9.10,
 10.2.2, 10.3, 11.1.3, 11.3.6, 12.2.2.1, **13.3**, 14, 15.2.8,
 15.4.1
Notice of Claims
 3.7.4, 10.2.8, **15.1.2**, 15.4
 Notice of Testing and Inspections
 13.5.1, 13.5.2
 Observations, Contractor's
 3.2, 3.7.4
 Occupancy
 2.2.2, 9.6.6, 9.8, 11.3.1.5
 Orders, Written
 1.1.1, 2.3, 3.9.2, 7, 8.2.2, 11.3.9, 12.1, 12.2.2.1, 13.5.2,
 14.3.1
OWNER
2
Owner, Definition of
2.1.1
Owner, Information and Services Required of the
 2.1.2, **2.2**, 3.2.2, 3.12.10, 6.1.3, 6.1.4, 6.2.5, 9.3.2,
 9.6.1, 9.6.4, 9.9.2, 9.10.3, 10.3.3, 11.2, 11.3, 13.5.1,
 13.5.2, 14.1.1.4, 14.1.4, 15.1.3

Owner's Authority
 1.5, 2.1.1, 2.3, 2.4, 3.4.2, 3.8.1, 3.12.10, 3.14.2, 4.1.2,
 4.1.3, 4.2.4, 4.2.9, 5.2.1, 5.2.4, 5.4.1, 6.1, 6.3, 7.2.1,
 7.3.1, 8.2.2, 8.3.1, 9.3.1, 9.3.2, 9.5.1, 9.6.4, 9.9.1,
 9.10.2, 10.3.2, 11.1.3, 11.3.3, 11.3.10, 12.2.2, 12.3,
 13.2.2, 14.3, 14.4, 15.2.7
 Owner's Financial Capability
 2.2.1, 13.2.2, 14.1.1.4
Owner's Liability Insurance
11.2
 Owner's Relationship with Subcontractors
 1.1.2, 5.2, 5.3, 5.4, 9.6.4, 9.10.2, 14.2.2
Owner's Right to Carry Out the Work
 2.4, 14.2.2
Owner's Right to Clean Up
6.3
Owner's Right to Perform Construction and to
Award Separate Contracts
6.1
Owner's Right to Stop the Work
2.3
 Owner's Right to Suspend the Work
 14.3
 Owner's Right to Terminate the Contract
 14.2
Ownership and Use of Drawings, Specifications
and Other Instruments of Service
 1.1.1, 1.1.6, 1.1.7, **1.5**, 2.2.5, 3.2.2, 3.11, 3.17, 4.2.12,
 5.3
Partial Occupancy or Use
 9.6.6, **9.9**, 11.3.1.5
Patching, Cutting and
3.14, 6.2.5
 Patents
 3.17
Payment, Applications for
 4.2.5, 7.3.9, 9.2, **9.3**, 9.4, 9.5, 9.6.3, 9.7, 9.8.5, 9.10.1,
 14.2.3, 14.2.4, 14.4.3
Payment, Certificates for
 4.2.5, 4.2.9, 9.3.3, **9.4**, 9.5, 9.6.1, 9.6.6, 9.7, 9.10.1,
 9.10.3, 13.7, 14.1.1.3, 14.2.4
Payment, Failure of
 9.5.1.3, **9.7**, 9.10.2, 13.6, 14.1.1.3, 14.2.1.2
 Payment, Final
 4.2.1, 4.2.9, 9.8.2, 9.10, 11.1.2, 11.1.3, 11.4.1, 12.3,
 13.7, 14.2.4, 14.4.3
Payment Bond, Performance Bond and
 7.3.7.4, 9.6.7, 9.10.3, **11.4**
Payments, Progress
 9.3, **9.6**, 9.8.5, 9.10.3, 13.6, 14.2.3, 15.1.3
PAYMENTS AND COMPLETION
9
 Payments to Subcontractors
 5.4.2, 9.5.1.3, 9.6.2, 9.6.3, 9.6.4, 9.6.7, 14.2.1.2
 PCB
 10.3.1

Performance Bond and Payment Bond
7.3.7.4, 9.6.7, 9.10.3, 11.4

Permits, Fees, Notices and Compliance with Laws
2.2.2, 3.7, 3.13, 7.3.7.4, 10.2.2

PERSONS AND PROPERTY, PROTECTION OF
10

Polychlorinated Biphenyl
10.3.1

Product Data, Definition of
3.12.2

Product Data and Samples, Shop Drawings
3.11, 3.12, 4.2.7

Progress and Completion
4.2.2, 8.2, 9.8, 9.9.1, 14.1.4, 15.1.3

Progress Payments
9.3, 9.6, 9.8.5, 9.10.3, 13.6, 14.2.3, 15.1.3

Project, Definition of
1.1.4

Project Representatives
4.2.10

Property Insurance
10.2.5, 11.3

PROTECTION OF PERSONS AND PROPERTY
10

Regulations and Laws
1.5, 3.2.3, 3.6, 3.7, 3.12.10, 3.13, 4.1.1, 9.6.4, 9.9.1,
10.2.2, 11.1, 11.4, 13.1, 13.4, 13.5.1, 13.5.2, 13.6, 14,
15.2.8, 15.4

Rejection of Work
3.5, 4.2.6, 12.2.1

Releases and Waivers of Liens
9.10.2

Representations
3.2.1, 3.5, 3.12.6, 6.2.2, 8.2.1, 9.3.3, 9.4.2, 9.5.1, 9.8.2,
9.10.1

Representatives
2.1.1, 3.1.1, 3.9, 4.1.1, 4.2.1, 4.2.2, 4.2.10, 5.1.1, 5.1.2,
13.2.1

Responsibility for Those Performing the Work
3.3.2, 3.18, 4.2.3, 5.3, 6.1.3, 6.2, 6.3, 9.5.1, 10

Retainage
9.3.1, 9.6.2, 9.8.5, 9.9.1, 9.10.2, 9.10.3

Review of Contract Documents and Field
Conditions by Contractor
3.2, 3.12.7, 6.1.3

Review of Contractor's Submittals by Owner and
Architect
3.10.1, 3.10.2, 3.11, 3.12, 4.2, 5.2, 6.1.3, 9.2, 9.8.2

Review of Shop Drawings, Product Data and Samples
by Contractor
3.12

Rights and Remedies
1.1.2, 2.3, 2.4, 3.5, 3.7.4, 3.15.2, 4.2.6, 5.3, 5.4, 6.1,
6.3, 7.3.1, 8.3, 9.5.1, 9.7, 10.2.5, 10.3, 12.2.2, 12.2.4,
13.4, 14, 15.4

Royalties, Patents and Copyrights
3.17

Rules and Notices for Arbitration
15.4.1

Safety of Persons and Property
10.2, 10.4

Safety Precautions and Programs
3.3.1, 4.2.2, 4.2.7, 5.3, 10.1, 10.2, 10.4

Samples, Definition of
3.12.3

Samples, Shop Drawings, Product Data and
3.11, 3.12, 4.2.7

Samples at the Site, Documents and
3.11

Schedule of Values
9.2, 9.3.1

Schedules, Construction
3.10, 3.12.1, 3.12.2, 6.1.3, 15.1.5.2

Separate Contracts and Contractors
1.1.4, 3.12.5, 3.14.2, 4.2.4, 4.2.7, 6, 8.3.1, 12.1.2

Shop Drawings, Definition of
3.12.1

Shop Drawings, Product Data and Samples
3.11, 3.12, 4.2.7

Site, Use of
3.13, 6.1.1, 6.2.1

Site Inspections
3.2.2, 3.3.3, 3.7.1, 3.7.4, 4.2, 9.4.2, 9.10.1, 13.5

Site Visits, Architect's
3.7.4, 4.2.2, 4.2.9, 9.4.2, 9.5.1, 9.9.2, 9.10.1, 13.5

Special Inspections and Testing
4.2.6, 12.2.1, 13.5

Specifications, Definition of
1.1.6

Specifications
1.1.1, 1.1.6, 1.2.2, 1.5, 3.11, 3.12.10, 3.17, 4.2.14

Statute of Limitations
13.7, 15.4.1.1

Stopping the Work
2.3, 9.7, 10.3, 14.1

Stored Materials
6.2.1, 9.3.2, 10.2.1.2, 10.2.4

Subcontractor, Definition of
5.1.1

SUBCONTRACTORS
5

Subcontractors, Work by
1.2.2, 3.3.2, 3.12.1, 4.2.3, 5.2.3, 5.3, 5.4, 9.3.1.2, 9.6.7

Subcontractual Relations
5.3, 5.4, 9.3.1.2, 9.6, 9.10, 10.2.1, 14.1, 14.2.1

Submittals
3.10, 3.11, 3.12, 4.2.7, 5.2.1, 5.2.3, 7.3.7, 9.2, 9.3, 9.8,
9.9.1, 9.10.2, 9.10.3, 11.1.3

Submittal Schedule
3.10.2, 3.12.5, 4.2.7

Subrogation, Waivers of
6.1.1, 11.3.7

Init.

Substantial Completion
4.2.9, 8.1.1, 8.1.3, 8.2.3, 9.4.2, **9.8**, 9.9.1, 9.10.3, 12.2, 13.7

Substantial Completion, Definition of
9.8.1

Substitution of Subcontractors
5.2.3, 5.2.4

Substitution of Architect
4.1.3

Substitutions of Materials
3.4.2, 3.5, 7.3.8

Sub-subcontractor, Definition of
5.1.2

Subsurface Conditions
3.7.4

Successors and Assigns
13.2

Superintendent
3.9, 10.2.6

Supervision and Construction Procedures
1.2.2, **3.3**, 3.4, 3.12.10, 4.2.2, 4.2.7, 6.1.3, 6.2.4, 7.1.3, 7.3.7, 8.2, 8.3.1, 9.4.2, 10, 12, 14, 15.1.3

Surety
5.4.1.2, 9.8.5, 9.10.2, 9.10.3, 14.2.2, 15.2.7

Surety, Consent of
9.10.2, 9.10.3

Surveys
2.2.3

Suspension by the Owner for Convenience
14.3

Suspension of the Work
5.4.2, 14.3

Suspension or Termination of the Contract
5.4.1.1, 14

Taxes
3.6, 3.8.2.1, 7.3.7.4

Termination by the Contractor
14.1, 15.1.6

Termination by the Owner for Cause
5.4.1.1, **14.2**, 15.1.6

Termination by the Owner for Convenience
14.4

Termination of the Architect
4.1.3

Termination of the Contractor
14.2.2

TERMINATION OR SUSPENSION OF THE CONTRACT
14

Tests and Inspections
3.1.3, 3.3.3, 4.2.2, 4.2.6, 4.2.9, 9.4.2, 9.8.3, 9.9.2, 9.10.1, 10.3.2, 11.4.1, 12.2.1, **13.5**

TIME
8

Time, Delays and Extensions of
3.2.4, 3.7.4, 5.2.3, 7.2.1, 7.3.1, 7.4, **8.3**, 9.5.1, 9.7, 10.3.2, 10.4, 14.3.2, 15.1.5, 15.2.5

Time Limits
2.1.2, 2.2, 2.4, 3.2.2, 3.10, 3.11, 3.12.5, 3.15.1, 4.2, 5.2, 5.3, 5.4, 6.2.4, 7.3, 7.4, 8.2, 9.2, 9.3.1, 9.3.3, 9.4.1, 9.5, 9.6, 9.7, 9.8, 9.9, 9.10, 11.1.3, 12.2, 13.5, 13.7, 14, 15.1.2, 15.4

Time Limits on Claims
3.7.4, 10.2.8, **13.7**, 15.1.2

Title to Work
9.3.2, 9.3.3

Transmission of Data in Digital Form
1.6

UNCOVERING AND CORRECTION OF WORK
12

Uncovering of Work
12.1

Unforeseen Conditions, Concealed or Unknown
3.7.4, 8.3.1, 10.3

Unit Prices
7.3.3.2, 7.3.4

Use of Documents
1.1.1, 1.5, 2.2.5, 3.12.6, 5.3

Use of Site
3.13, 6.1.1, 6.2.1

Values, Schedule of
9.2, 9.3.1

Waiver of Claims by the Architect
13.4.2

Waiver of Claims by the Contractor
9.10.5, 13.4.2, 15.1.6

Waiver of Claims by the Owner
9.9.3, 9.10.3, 9.10.4, 12.2.2.1, 13.4.2, 14.2.4, 15.1.6

Waiver of Consequential Damages
14.2.4, 15.1.6

Waiver of Liens
9.10.2, 9.10.4

Waivers of Subrogation
6.1.1, **11.3.7**

Warranty
3.5, 4.2.9, 9.3.3, 9.8.4, 9.9.1, 9.10.4, 12.2.2, 13.7

Weather Delays
15.1.5.2

Work, Definition of
1.1.3

Written Consent
1.5.2, 3.4.2, 3.7.4, 3.12.8, 3.14.2, 4.1.2, 9.3.2, 9.8.5, 9.9.1, 9.10.2, 9.10.3, 11.4.1, 13.2, 13.4.2, 15.4.4.2

Written Interpretations
4.2.11, 4.2.12

Written Notice
2.3, 2.4, 3.3.1, 3.9, 3.12.9, 3.12.10, 5.2.1, 8.2.2, 9.7, 9.10, 10.2.2, 10.3, 11.1.3, 12.2.2, 12.2.4, **13.3**, 14, 15.4.1

Written Orders
1.1.1, 2.3, 3.9, 7, 8.2.2, 12.1, 12.2, 13.5.2, 14.3.1, 15.1.2

ARTICLE 1 GENERAL PROVISIONS

§ 1.1 BASIC DEFINITIONS

§ 1.1.1 THE CONTRACT DOCUMENTS

The Contract Documents are enumerated in the Agreement between the Owner and Contractor (hereinafter the Agreement) and consist of the Agreement, Conditions of the Contract (General, Supplementary and other Conditions), Drawings, Specifications, Addenda issued prior to execution of the Contract, other documents listed in the Agreement and Modifications issued after execution of the Contract. A Modification is (1) a written amendment to the Contract signed by both parties, (2) a Change Order, (3) a Construction Change Directive or (4) a written order for a minor change in the Work issued by the Architect. Unless specifically enumerated in the Agreement, the Contract Documents do not include the advertisement or invitation to bid, Instructions to Bidders, sample forms, other information furnished by the Owner in anticipation of receiving bids or proposals, the Contractor's bid or proposal, or portions of Addenda relating to bidding requirements.

§ 1.1.2 THE CONTRACT

The Contract Documents form the Contract for Construction. The Contract represents the entire and integrated agreement between the parties hereto and supersedes prior negotiations, representations or agreements, either written or oral. The Contract may be amended or modified only by a Modification. The Contract Documents shall not be construed to create a contractual relationship of any kind (1) between the Contractor and the Architect or the Architect's consultants, (2) between the Owner and a Subcontractor or a Sub-subcontractor, (3) between the Owner and the Architect or the Architect's consultants or (4) between any persons or entities other than the Owner and the Contractor. The Architect shall, however, be entitled to performance and enforcement of obligations under the Contract intended to facilitate performance of the Architect's duties.

§ 1.1.3 THE WORK

The term "Work" means the construction and services required by the Contract Documents, whether completed or partially completed, and includes all other labor, materials, equipment and services provided or to be provided by the Contractor to fulfill the Contractor's obligations. The Work may constitute the whole or a part of the Project.

§ 1.1.4 THE PROJECT

The Project is the total construction of which the Work performed under the Contract Documents may be the whole or a part and which may include construction by the Owner and by separate contractors.

§ 1.1.5 THE DRAWINGS

The Drawings are the graphic and pictorial portions of the Contract Documents showing the design, location and dimensions of the Work, generally including plans, elevations, sections, details, schedules and diagrams.

§ 1.1.6 THE SPECIFICATIONS

The Specifications are that portion of the Contract Documents consisting of the written requirements for materials, equipment, systems, standards and workmanship for the Work, and performance of related services.

§ 1.1.7 INSTRUMENTS OF SERVICE

Instruments of Service are representations, in any medium of expression now known or later developed, of the tangible and intangible creative work performed by the Architect and the Architect's consultants under their respective professional services agreements. Instruments of Service may include, without limitation, studies, surveys, models, sketches, drawings, specifications, and other similar materials.

§ 1.1.8 INITIAL DECISION MAKER

The Initial Decision Maker is the person identified in the Agreement to render initial decisions on Claims in accordance with Section 15.2 and certify termination of the Agreement under Section 14.2.2.

§ 1.2 CORRELATION AND INTENT OF THE CONTRACT DOCUMENTS

§ 1.2.1 The intent of the Contract Documents is to include all items necessary for the proper execution and completion of the Work by the Contractor. The Contract Documents are complementary, and what is required by one shall be as binding as if required by all; performance by the Contractor shall be required only to the extent consistent with the Contract Documents and reasonably inferable from them as being necessary to produce the indicated results.

§ 1.2.2 Organization of the Specifications into divisions, sections and articles, and arrangement of Drawings shall not control the Contractor in dividing the Work among Subcontractors or in establishing the extent of Work to be performed by any trade.

§ 1.2.3 Unless otherwise stated in the Contract Documents, words that have well-known technical or construction industry meanings are used in the Contract Documents in accordance with such recognized meanings.

§ 1.3 CAPITALIZATION

Terms capitalized in these General Conditions include those that are (1) specifically defined, (2) the titles of numbered articles or (3) the titles of other documents published by the American Institute of Architects.

§ 1.4 INTERPRETATION

In the interest of brevity the Contract Documents frequently omit modifying words such as "all" and "any" and articles such as "the" and "an," but the fact that a modifier or an article is absent from one statement and appears in another is not intended to affect the interpretation of either statement.

§ 1.5 OWNERSHIP AND USE OF DRAWINGS, SPECIFICATIONS AND OTHER INSTRUMENTS OF SERVICE

§ 1.5.1 The Architect and the Architect's consultants shall be deemed the authors and owners of their respective Instruments of Service, including the Drawings and Specifications, and will retain all common law, statutory and other reserved rights, including copyrights. The Contractor, Subcontractors, Sub-subcontractors, and material or equipment suppliers shall not own or claim a copyright in the Instruments of Service. Submittal or distribution to meet official regulatory requirements or for other purposes in connection with this Project is not to be construed as publication in derogation of the Architect's or Architect's consultants' reserved rights.

§ 1.5.2 The Contractor, Subcontractors, Sub-subcontractors and material or equipment suppliers are authorized to use and reproduce the Instruments of Service provided to them solely and exclusively for execution of the Work. All copies made under this authorization shall bear the copyright notice, if any, shown on the Instruments of Service. The Contractor, Subcontractors, Sub-subcontractors, and material or equipment suppliers may not use the Instruments of Service on other projects or for additions to this Project outside the scope of the Work without the specific written consent of the Owner, Architect and the Architect's consultants.

§ 1.6 TRANSMISSION OF DATA IN DIGITAL FORM

If the parties intend to transmit Instruments of Service or any other information or documentation in digital form, they shall endeavor to establish necessary protocols governing such transmissions, unless otherwise already provided in the Agreement or the Contract Documents.

ARTICLE 2 OWNER

§ 2.1 GENERAL

§ 2.1.1 The Owner is the person or entity identified as such in the Agreement and is referred to throughout the Contract Documents as if singular in number. The Owner shall designate in writing a representative who shall have express authority to bind the Owner with respect to all matters requiring the Owner's approval or authorization. Except as otherwise provided in Section 4.2.1, the Architect does not have such authority. The term "Owner" means the Owner or the Owner's authorized representative.

§ 2.1.2 The Owner shall furnish to the Contractor within fifteen days after receipt of a written request, information necessary and relevant for the Contractor to evaluate, give notice of or enforce mechanic's lien rights. Such information shall include a correct statement of the record legal title to the property on which the Project is located, usually referred to as the site, and the Owner's interest therein.

§ 2.2 INFORMATION AND SERVICES REQUIRED OF THE OWNER

§ 2.2.1 Prior to commencement of the Work, the Contractor may request in writing that the Owner provide reasonable evidence that the Owner has made financial arrangements to fulfill the Owner's obligations under the Contract. Thereafter, the Contractor may only request such evidence if (1) the Owner fails to make payments to the Contractor as the Contract Documents require; (2) a change in the Work materially changes the Contract Sum; or (3) the Contractor identifies in writing a reasonable concern regarding the Owner's ability to make payment when due. The Owner shall furnish such evidence as a condition precedent to commencement or continuation of the Work or the

portion of the Work affected by a material change. After the Owner furnishes the evidence, the Owner shall not materially vary such financial arrangements without prior notice to the Contractor.

§ 2.2.2 Except for permits and fees that are the responsibility of the Contractor under the Contract Documents, including those required under Section 3.7.1, the Owner shall secure and pay for necessary approvals, easements, assessments and charges required for construction, use or occupancy of permanent structures or for permanent changes in existing facilities.

§ 2.2.3 The Owner shall furnish surveys describing physical characteristics, legal limitations and utility locations for the site of the Project, and a legal description of the site. The Contractor shall be entitled to rely on the accuracy of information furnished by the Owner but shall exercise proper precautions relating to the safe performance of the Work.

§ 2.2.4 The Owner shall furnish information or services required of the Owner by the Contract Documents with reasonable promptness. The Owner shall also furnish any other information or services under the Owner's control and relevant to the Contractor's performance of the Work with reasonable promptness after receiving the Contractor's written request for such information or services.

§ 2.2.5 Unless otherwise provided in the Contract Documents, the Owner shall furnish to the Contractor one copy of the Contract Documents for purposes of making reproductions pursuant to Section 1.5.2.

§ 2.3 OWNER'S RIGHT TO STOP THE WORK

If the Contractor fails to correct Work that is not in accordance with the requirements of the Contract Documents as required by Section 12.2 or repeatedly fails to carry out Work in accordance with the Contract Documents, the Owner may issue a written order to the Contractor to stop the Work, or any portion thereof, until the cause for such order has been eliminated; however, the right of the Owner to stop the Work shall not give rise to a duty on the part of the Owner to exercise this right for the benefit of the Contractor or any other person or entity, except to the extent required by Section 6.1.3.

§ 2.4 OWNER'S RIGHT TO CARRY OUT THE WORK

If the Contractor defaults or neglects to carry out the Work in accordance with the Contract Documents and fails within a ten-day period after receipt of written notice from the Owner to commence and continue correction of such default or neglect with diligence and promptness, the Owner may, without prejudice to other remedies the Owner may have, correct such deficiencies. In such case an appropriate Change Order shall be issued deducting from payments then or thereafter due the Contractor the reasonable cost of correcting such deficiencies, including Owner's expenses and compensation for the Architect's additional services made necessary by such default, neglect or failure. Such action by the Owner and amounts charged to the Contractor are both subject to prior approval of the Architect. If payments then or thereafter due the Contractor are not sufficient to cover such amounts, the Contractor shall pay the difference to the Owner.

ARTICLE 3 CONTRACTOR

§ 3.1 GENERAL

§ 3.1.1 The Contractor is the person or entity identified as such in the Agreement and is referred to throughout the Contract Documents as if singular in number. The Contractor shall be lawfully licensed, if required in the jurisdiction where the Project is located. The Contractor shall designate in writing a representative who shall have express authority to bind the Contractor with respect to all matters under this Contract. The term "Contractor" means the Contractor or the Contractor's authorized representative.

§ 3.1.2 The Contractor shall perform the Work in accordance with the Contract Documents.

§ 3.1.3 The Contractor shall not be relieved of obligations to perform the Work in accordance with the Contract Documents either by activities or duties of the Architect in the Architect's administration of the Contract, or by tests, inspections or approvals required or performed by persons or entities other than the Contractor.

§ 3.2 REVIEW OF CONTRACT DOCUMENTS AND FIELD CONDITIONS BY CONTRACTOR

§ 3.2.1 Execution of the Contract by the Contractor is a representation that the Contractor has visited the site, become generally familiar with local conditions under which the Work is to be performed and correlated personal observations with requirements of the Contract Documents.

§ 3.2.2 Because the Contract Documents are complementary, the Contractor shall, before starting each portion of the Work, carefully study and compare the various Contract Documents relative to that portion of the Work, as well as the information furnished by the Owner pursuant to Section 2.2.3, shall take field measurements of any existing conditions related to that portion of the Work, and shall observe any conditions at the site affecting it. These obligations are for the purpose of facilitating coordination and construction by the Contractor and are not for the purpose of discovering errors, omissions, or inconsistencies in the Contract Documents; however, the Contractor shall promptly report to the Architect any errors, inconsistencies or omissions discovered by or made known to the Contractor as a request for information in such form as the Architect may require. It is recognized that the Contractor's review is made in the Contractor's capacity as a contractor and not as a licensed design professional, unless otherwise specifically provided in the Contract Documents.

§ 3.2.3 The Contractor is not required to ascertain that the Contract Documents are in accordance with applicable laws, statutes, ordinances, codes, rules and regulations, or lawful orders of public authorities, but the Contractor shall promptly report to the Architect any nonconformity discovered by or made known to the Contractor as a request for information in such form as the Architect may require.

§ 3.2.4 If the Contractor believes that additional cost or time is involved because of clarifications or instructions the Architect issues in response to the Contractor's notices or requests for information pursuant to Sections 3.2.2 or 3.2.3, the Contractor shall make Claims as provided in Article 15. If the Contractor fails to perform the obligations of Sections 3.2.2 or 3.2.3, the Contractor shall pay such costs and damages to the Owner as would have been avoided if the Contractor had performed such obligations. If the Contractor performs those obligations, the Contractor shall not be liable to the Owner or Architect for damages resulting from errors, inconsistencies or omissions in the Contract Documents, for differences between field measurements or conditions and the Contract Documents, or for nonconformities of the Contract Documents to applicable laws, statutes, ordinances, codes, rules and regulations, and lawful orders of public authorities.

§ 3.3 SUPERVISION AND CONSTRUCTION PROCEDURES

§ 3.3.1 The Contractor shall supervise and direct the Work, using the Contractor's best skill and attention. The Contractor shall be solely responsible for, and have control over, construction means, methods, techniques, sequences and procedures and for coordinating all portions of the Work under the Contract, unless the Contract Documents give other specific instructions concerning these matters. If the Contract Documents give specific instructions concerning construction means, methods, techniques, sequences or procedures, the Contractor shall evaluate the jobsite safety thereof and, except as stated below, shall be fully and solely responsible for the jobsite safety of such means, methods, techniques, sequences or procedures. If the Contractor determines that such means, methods, techniques, sequences or procedures may not be safe, the Contractor shall give timely written notice to the Owner and Architect and shall not proceed with that portion of the Work without further written instructions from the Architect. If the Contractor is then instructed to proceed with the required means, methods, techniques, sequences or procedures without acceptance of changes proposed by the Contractor, the Owner shall be solely responsible for any loss or damage arising solely from those Owner-required means, methods, techniques, sequences or procedures.

§ 3.3.2 The Contractor shall be responsible to the Owner for acts and omissions of the Contractor's employees, Subcontractors and their agents and employees, and other persons or entities performing portions of the Work for, or on behalf of, the Contractor or any of its Subcontractors.

§ 3.3.3 The Contractor shall be responsible for inspection of portions of Work already performed to determine that such portions are in proper condition to receive subsequent Work.

§ 3.4 LABOR AND MATERIALS

§ 3.4.1 Unless otherwise provided in the Contract Documents, the Contractor shall provide and pay for labor, materials, equipment, tools, construction equipment and machinery, water, heat, utilities, transportation, and other facilities and services necessary for proper execution and completion of the Work, whether temporary or permanent and whether or not incorporated or to be incorporated in the Work.

Init.

§ 3.4.2 Except in the case of minor changes in the Work authorized by the Architect in accordance with Sections 3.12.8 or 7.4, the Contractor may make substitutions only with the consent of the Owner, after evaluation by the Architect and in accordance with a Change Order or Construction Change Directive.

§ 3.4.3 The Contractor shall enforce strict discipline and good order among the Contractor's employees and other persons carrying out the Work. The Contractor shall not permit employment of unfit persons or persons not properly skilled in tasks assigned to them.

§ 3.5 WARRANTY

The Contractor warrants to the Owner and Architect that materials and equipment furnished under the Contract will be of good quality and new unless the Contract Documents require or permit otherwise. The Contractor further warrants that the Work will conform to the requirements of the Contract Documents and will be free from defects, except for those inherent in the quality of the Work the Contract Documents require or permit. Work, materials, or equipment not conforming to these requirements may be considered defective. The Contractor's warranty excludes remedy for damage or defect caused by abuse, alterations to the Work not executed by the Contractor, improper or insufficient maintenance, improper operation, or normal wear and tear and normal usage. If required by the Architect, the Contractor shall furnish satisfactory evidence as to the kind and quality of materials and equipment.

§ 3.6 TAXES

The Contractor shall pay sales, consumer, use and similar taxes for the Work provided by the Contractor that are legally enacted when bids are received or negotiations concluded, whether or not yet effective or merely scheduled to go into effect.

§ 3.7 PERMITS, FEES, NOTICES AND COMPLIANCE WITH LAWS

§ 3.7.1 Unless otherwise provided in the Contract Documents, the Contractor shall secure and pay for the building permit as well as for other permits, fees, licenses, and inspections by government agencies necessary for proper execution and completion of the Work that are customarily secured after execution of the Contract and legally required at the time bids are received or negotiations concluded.

§ 3.7.2 The Contractor shall comply with and give notices required by applicable laws, statutes, ordinances, codes, rules and regulations, and lawful orders of public authorities applicable to performance of the Work.

§ 3.7.3 If the Contractor performs Work knowing it to be contrary to applicable laws, statutes, ordinances, codes, rules and regulations, or lawful orders of public authorities, the Contractor shall assume appropriate responsibility for such Work and shall bear the costs attributable to correction.

§ 3.7.4 **Concealed or Unknown Conditions.** If the Contractor encounters conditions at the site that are (1) subsurface or otherwise concealed physical conditions that differ materially from those indicated in the Contract Documents or (2) unknown physical conditions of an unusual nature, that differ materially from those ordinarily found to exist and generally recognized as inherent in construction activities of the character provided for in the Contract Documents, the Contractor shall promptly provide notice to the Owner and the Architect before conditions are disturbed and in no event later than 21 days after first observance of the conditions. The Architect will promptly investigate such conditions and, if the Architect determines that they differ materially and cause an increase or decrease in the Contractor's cost of, or time required for, performance of any part of the Work, will recommend an equitable adjustment in the Contract Sum or Contract Time, or both. If the Architect determines that the conditions at the site are not materially different from those indicated in the Contract Documents and that no change in the terms of the Contract is justified, the Architect shall promptly notify the Owner and Contractor in writing, stating the reasons. If either party disputes the Architect's determination or recommendation, that party may proceed as provided in Article 15.

§ 3.7.5 If, in the course of the Work, the Contractor encounters human remains or recognizes the existence of burial markers, archaeological sites or wetlands not indicated in the Contract Documents, the Contractor shall immediately suspend any operations that would affect them and shall notify the Owner and Architect. Upon receipt of such notice, the Owner shall promptly take any action necessary to obtain governmental authorization required to resume the operations. The Contractor shall continue to suspend such operations until otherwise instructed by the Owner but shall continue with all other operations that do not affect those remains or features. Requests for adjustments in the Contract Sum and Contract Time arising from the existence of such remains or features may be made as provided in Article 15.

Init.

§ 3.8 ALLOWANCES

§ 3.8.1 The Contractor shall include in the Contract Sum all allowances stated in the Contract Documents. Items covered by allowances shall be supplied for such amounts and by such persons or entities as the Owner may direct, but the Contractor shall not be required to employ persons or entities to whom the Contractor has reasonable objection.

§ 3.8.2 Unless otherwise provided in the Contract Documents,

- .1 Allowances shall cover the cost to the Contractor of materials and equipment delivered at the site and all required taxes, less applicable trade discounts;
- .2 Contractor's costs for unloading and handling at the site, labor, installation costs, overhead, profit and other expenses contemplated for stated allowance amounts shall be included in the Contract Sum but not in the allowances; and
- .3 Whenever costs are more than or less than allowances, the Contract Sum shall be adjusted accordingly by Change Order. The amount of the Change Order shall reflect (1) the difference between actual costs and the allowances under Section 3.8.2.1 and (2) changes in Contractor's costs under Section 3.8.2.2.

§ 3.8.3 Materials and equipment under an allowance shall be selected by the Owner with reasonable promptness.

§ 3.9 SUPERINTENDENT

§ 3.9.1 The Contractor shall employ a competent superintendent and necessary assistants who shall be in attendance at the Project site during performance of the Work. The superintendent shall represent the Contractor, and communications given to the superintendent shall be as binding as if given to the Contractor.

§ 3.9.2 The Contractor, as soon as practicable after award of the Contract, shall furnish in writing to the Owner through the Architect the name and qualifications of a proposed superintendent. The Architect may reply within 14 days to the Contractor in writing stating (1) whether the Owner or the Architect has reasonable objection to the proposed superintendent or (2) that the Architect requires additional time to review. Failure of the Architect to reply within the 14 day period shall constitute notice of no reasonable objection.

§ 3.9.3 The Contractor shall not employ a proposed superintendent to whom the Owner or Architect has made reasonable and timely objection. The Contractor shall not change the superintendent without the Owner's consent, which shall not unreasonably be withheld or delayed.

§ 3.10 CONTRACTOR'S CONSTRUCTION SCHEDULES

§ 3.10.1 The Contractor, promptly after being awarded the Contract, shall prepare and submit for the Owner's and Architect's information a Contractor's construction schedule for the Work. The schedule shall not exceed time limits current under the Contract Documents, shall be revised at appropriate intervals as required by the conditions of the Work and Project, shall be related to the entire Project to the extent required by the Contract Documents, and shall provide for expeditious and practicable execution of the Work.

§ 3.10.2 The Contractor shall prepare a submittal schedule, promptly after being awarded the Contract and thereafter as necessary to maintain a current submittal schedule, and shall submit the schedule(s) for the Architect's approval. The Architect's approval shall not unreasonably be delayed or withheld. The submittal schedule shall (1) be coordinated with the Contractor's construction schedule, and (2) allow the Architect reasonable time to review submittals. If the Contractor fails to submit a submittal schedule, the Contractor shall not be entitled to any increase in Contract Sum or extension of Contract Time based on the time required for review of submittals.

§ 3.10.3 The Contractor shall perform the Work in general accordance with the most recent schedules submitted to the Owner and Architect.

§ 3.11 DOCUMENTS AND SAMPLES AT THE SITE

The Contractor shall maintain at the site for the Owner one copy of the Drawings, Specifications, Addenda, Change Orders and other Modifications, in good order and marked currently to indicate field changes and selections made during construction, and one copy of approved Shop Drawings, Product Data, Samples and similar required submittals. These shall be available to the Architect and shall be delivered to the Architect for submittal to the Owner upon completion of the Work as a record of the Work as constructed.

§ 3.12 SHOP DRAWINGS, PRODUCT DATA AND SAMPLES

§ 3.12.1 Shop Drawings are drawings, diagrams, schedules and other data specially prepared for the Work by the Contractor or a Subcontractor, Sub-subcontractor, manufacturer, supplier or distributor to illustrate some portion of the Work.

§ 3.12.2 Product Data are illustrations, standard schedules, performance charts, instructions, brochures, diagrams and other information furnished by the Contractor to illustrate materials or equipment for some portion of the Work.

§ 3.12.3 Samples are physical examples that illustrate materials, equipment or workmanship and establish standards by which the Work will be judged.

§ 3.12.4 Shop Drawings, Product Data, Samples and similar submittals are not Contract Documents. Their purpose is to demonstrate the way by which the Contractor proposes to conform to the information given and the design concept expressed in the Contract Documents for those portions of the Work for which the Contract Documents require submittals. Review by the Architect is subject to the limitations of Section 4.2.7. Informational submittals upon which the Architect is not expected to take responsive action may be so identified in the Contract Documents. Submittals that are not required by the Contract Documents may be returned by the Architect without action.

§ 3.12.5 The Contractor shall review for compliance with the Contract Documents, approve and submit to the Architect Shop Drawings, Product Data, Samples and similar submittals required by the Contract Documents in accordance with the submittal schedule approved by the Architect or, in the absence of an approved submittal schedule, with reasonable promptness and in such sequence as to cause no delay in the Work or in the activities of the Owner or of separate contractors.

§ 3.12.6 By submitting Shop Drawings, Product Data, Samples and similar submittals, the Contractor represents to the Owner and Architect that the Contractor has (1) reviewed and approved them, (2) determined and verified materials, field measurements and field construction criteria related thereto, or will do so and (3) checked and coordinated the information contained within such submittals with the requirements of the Work and of the Contract Documents.

§ 3.12.7 The Contractor shall perform no portion of the Work for which the Contract Documents require submittal and review of Shop Drawings, Product Data, Samples or similar submittals until the respective submittal has been approved by the Architect.

§ 3.12.8 The Work shall be in accordance with approved submittals except that the Contractor shall not be relieved of responsibility for deviations from requirements of the Contract Documents by the Architect's approval of Shop Drawings, Product Data, Samples or similar submittals unless the Contractor has specifically informed the Architect in writing of such deviation at the time of submittal and (1) the Architect has given written approval to the specific deviation as a minor change in the Work, or (2) a Change Order or Construction Change Directive has been issued authorizing the deviation. The Contractor shall not be relieved of responsibility for errors or omissions in Shop Drawings, Product Data, Samples or similar submittals by the Architect's approval thereof.

§ 3.12.9 The Contractor shall direct specific attention, in writing or on resubmitted Shop Drawings, Product Data, Samples or similar submittals, to revisions other than those requested by the Architect on previous submittals. In the absence of such written notice, the Architect's approval of a resubmission shall not apply to such revisions.

§ 3.12.10 The Contractor shall not be required to provide professional services that constitute the practice of architecture or engineering unless such services are specifically required by the Contract Documents for a portion of the Work or unless the Contractor needs to provide such services in order to carry out the Contractor's responsibilities for construction means, methods, techniques, sequences and procedures. The Contractor shall not be required to provide professional services in violation of applicable law. If professional design services or certifications by a design professional related to systems, materials or equipment are specifically required of the Contractor by the Contract Documents, the Owner and the Architect will specify all performance and design criteria that such services must satisfy. The Contractor shall cause such services or certifications to be provided by a properly licensed design professional, whose signature and seal shall appear on all drawings, calculations, specifications, certifications, Shop Drawings and other submittals prepared by such professional. Shop Drawings and other submittals related to the Work designed or certified by such professional, if prepared by others, shall bear such professional's written approval when submitted to the Architect. The Owner and the Architect shall be entitled to rely upon the adequacy, accuracy and

Init.

completeness of the services, certifications and approvals performed or provided by such design professionals, provided the Owner and Architect have specified to the Contractor all performance and design criteria that such services must satisfy. Pursuant to this Section 3.12.10, the Architect will review, approve or take other appropriate action on submittals only for the limited purpose of checking for conformance with information given and the design concept expressed in the Contract Documents. The Contractor shall not be responsible for the adequacy of the performance and design criteria specified in the Contract Documents.

§ 3.13 USE OF SITE

The Contractor shall confine operations at the site to areas permitted by applicable laws, statutes, ordinances, codes, rules and regulations, and lawful orders of public authorities and the Contract Documents and shall not unreasonably encumber the site with materials or equipment.

§ 3.14 CUTTING AND PATCHING

§ 3.14.1 The Contractor shall be responsible for cutting, fitting or patching required to complete the Work or to make its parts fit together properly. All areas requiring cutting, fitting and patching shall be restored to the condition existing prior to the cutting, fitting and patching, unless otherwise required by the Contract Documents.

§ 3.14.2 The Contractor shall not damage or endanger a portion of the Work or fully or partially completed construction of the Owner or separate contractors by cutting, patching or otherwise altering such construction, or by excavation. The Contractor shall not cut or otherwise alter such construction by the Owner or a separate contractor except with written consent of the Owner and of such separate contractor; such consent shall not be unreasonably withheld. The Contractor shall not unreasonably withhold from the Owner or a separate contractor the Contractor's consent to cutting or otherwise altering the Work.

§ 3.15 CLEANING UP

§ 3.15.1 The Contractor shall keep the premises and surrounding area free from accumulation of waste materials or rubbish caused by operations under the Contract. At completion of the Work, the Contractor shall remove waste materials, rubbish, the Contractor's tools, construction equipment, machinery and surplus materials from and about the Project.

§ 3.15.2 If the Contractor fails to clean up as provided in the Contract Documents, the Owner may do so and Owner shall be entitled to reimbursement from the Contractor.

§ 3.16 ACCESS TO WORK

The Contractor shall provide the Owner and Architect access to the Work in preparation and progress wherever located.

§ 3.17 ROYALTIES, PATENTS AND COPYRIGHTS

The Contractor shall pay all royalties and license fees. The Contractor shall defend suits or claims for infringement of copyrights and patent rights and shall hold the Owner and Architect harmless from loss on account thereof, but shall not be responsible for such defense or loss when a particular design, process or product of a particular manufacturer or manufacturers is required by the Contract Documents, or where the copyright violations are contained in Drawings, Specifications or other documents prepared by the Owner or Architect. However, if the Contractor has reason to believe that the required design, process or product is an infringement of a copyright or a patent, the Contractor shall be responsible for such loss unless such information is promptly furnished to the Architect.

§ 3.18 INDEMNIFICATION

§ 3.18.1 To the fullest extent permitted by law the Contractor shall indemnify and hold harmless the Owner, Architect, Architect's consultants, and agents and employees of any of them from and against claims, damages, losses and expenses, including but not limited to attorneys' fees, arising out of or resulting from performance of the Work, provided that such claim, damage, loss or expense is attributable to bodily injury, sickness, disease or death, or to injury to or destruction of tangible property (other than the Work itself), but only to the extent caused by the negligent acts or omissions of the Contractor, a Subcontractor, anyone directly or indirectly employed by them or anyone for whose acts they may be liable, regardless of whether or not such claim, damage, loss or expense is caused in part by a party indemnified hereunder. Such obligation shall not be construed to negate, abridge, or reduce other rights or obligations of indemnity that would otherwise exist as to a party or person described in this Section 3.18.

§ 3.18.2 In claims against any person or entity indemnified under this Section 3.18 by an employee of the Contractor, a Subcontractor, anyone directly or indirectly employed by them or anyone for whose acts they may be liable, the indemnification obligation under Section 3.18.1 shall not be limited by a limitation on amount or type of damages, compensation or benefits payable by or for the Contractor or a Subcontractor under workers' compensation acts, disability benefit acts or other employee benefit acts.

ARTICLE 4 ARCHITECT

§ 4.1 GENERAL

§ 4.1.1 The Owner shall retain an architect lawfully licensed to practice architecture or an entity lawfully practicing architecture in the jurisdiction where the Project is located. That person or entity is identified as the Architect in the Agreement and is referred to throughout the Contract Documents as if singular in number.

§ 4.1.2 Duties, responsibilities and limitations of authority of the Architect as set forth in the Contract Documents shall not be restricted, modified or extended without written consent of the Owner, Contractor and Architect. Consent shall not be unreasonably withheld.

§ 4.1.3 If the employment of the Architect is terminated, the Owner shall employ a successor architect as to whom the Contractor has no reasonable objection and whose status under the Contract Documents shall be that of the Architect.

§ 4.2 ADMINISTRATION OF THE CONTRACT

§ 4.2.1 The Architect will provide administration of the Contract as described in the Contract Documents and will be an Owner's representative during construction until the date the Architect issues the final Certificate for Payment. The Architect will have authority to act on behalf of the Owner only to the extent provided in the Contract Documents.

§ 4.2.2 The Architect will visit the site at intervals appropriate to the stage of construction, or as otherwise agreed with the Owner, to become generally familiar with the progress and quality of the portion of the Work completed, and to determine in general if the Work observed is being performed in a manner indicating that the Work, when fully completed, will be in accordance with the Contract Documents. However, the Architect will not be required to make exhaustive or continuous on-site inspections to check the quality or quantity of the Work. The Architect will not have control over, charge of, or responsibility for, the construction means, methods, techniques, sequences or procedures, or for the safety precautions and programs in connection with the Work, since these are solely the Contractor's rights and responsibilities under the Contract Documents, except as provided in Section 3.3.1.

§ 4.2.3 On the basis of the site visits, the Architect will keep the Owner reasonably informed about the progress and quality of the portion of the Work completed, and report to the Owner (1) known deviations from the Contract Documents and from the most recent construction schedule submitted by the Contractor, and (2) defects and deficiencies observed in the Work. The Architect will not be responsible for the Contractor's failure to perform the Work in accordance with the requirements of the Contract Documents. The Architect will not have control over or charge of and will not be responsible for acts or omissions of the Contractor, Subcontractors, or their agents or employees, or any other persons or entities performing portions of the Work.

§ 4.2.4 COMMUNICATIONS FACILITATING CONTRACT ADMINISTRATION

Except as otherwise provided in the Contract Documents or when direct communications have been specially authorized, the Owner and Contractor shall endeavor to communicate with each other through the Architect about matters arising out of or relating to the Contract. Communications by and with the Architect's consultants shall be through the Architect. Communications by and with Subcontractors and material suppliers shall be through the Contractor. Communications by and with separate contractors shall be through the Owner.

§ 4.2.5 Based on the Architect's evaluations of the Contractor's Applications for Payment, the Architect will review and certify the amounts due the Contractor and will issue Certificates for Payment in such amounts.

§ 4.2.6 The Architect has authority to reject Work that does not conform to the Contract Documents. Whenever the Architect considers it necessary or advisable, the Architect will have authority to require inspection or testing of the Work in accordance with Sections 13.5.2 and 13.5.3, whether or not such Work is fabricated, installed or completed. However, neither this authority of the Architect nor a decision made in good faith either to exercise or not to exercise such authority shall give rise to a duty or responsibility of the Architect to the Contractor, Subcontractors, material and equipment suppliers, their agents or employees, or other persons or entities performing portions of the Work.

Init.

§ 4.2.7 The Architect will review and approve, or take other appropriate action upon, the Contractor's submittals such as Shop Drawings, Product Data and Samples, but only for the limited purpose of checking for conformance with information given and the design concept expressed in the Contract Documents. The Architect's action will be taken in accordance with the submittal schedule approved by the Architect or, in the absence of an approved submittal schedule, with reasonable promptness while allowing sufficient time in the Architect's professional judgment to permit adequate review. Review of such submittals is not conducted for the purpose of determining the accuracy and completeness of other details such as dimensions and quantities, or for substantiating instructions for installation or performance of equipment or systems, all of which remain the responsibility of the Contractor as required by the Contract Documents. The Architect's review of the Contractor's submittals shall not relieve the Contractor of the obligations under Sections 3.3, 3.5 and 3.12. The Architect's review shall not constitute approval of safety precautions or, unless otherwise specifically stated by the Architect, of any construction means, methods, techniques, sequences or procedures. The Architect's approval of a specific item shall not indicate approval of an assembly of which the item is a component.

§ 4.2.8 The Architect will prepare Change Orders and Construction Change Directives, and may authorize minor changes in the Work as provided in Section 7.4. The Architect will investigate and make determinations and recommendations regarding concealed and unknown conditions as provided in Section 3.7.4.

§ 4.2.9 The Architect will conduct inspections to determine the date or dates of Substantial Completion and the date of final completion; issue Certificates of Substantial Completion pursuant to Section 9.8; receive and forward to the Owner, for the Owner's review and records, written warranties and related documents required by the Contract and assembled by the Contractor pursuant to Section 9.10; and issue a final Certificate for Payment pursuant to Section 9.10.

§ 4.2.10 If the Owner and Architect agree, the Architect will provide one or more project representatives to assist in carrying out the Architect's responsibilities at the site. The duties, responsibilities and limitations of authority of such project representatives shall be as set forth in an exhibit to be incorporated in the Contract Documents.

§ 4.2.11 The Architect will interpret and decide matters concerning performance under, and requirements of, the Contract Documents on written request of either the Owner or Contractor. The Architect's response to such requests will be made in writing within any time limits agreed upon or otherwise with reasonable promptness.

§ 4.2.12 Interpretations and decisions of the Architect will be consistent with the intent of, and reasonably inferable from, the Contract Documents and will be in writing or in the form of drawings. When making such interpretations and decisions, the Architect will endeavor to secure faithful performance by both Owner and Contractor, will not show partiality to either and will not be liable for results of interpretations or decisions rendered in good faith.

§ 4.2.13 The Architect's decisions on matters relating to aesthetic effect will be final if consistent with the intent expressed in the Contract Documents.

§ 4.2.14 The Architect will review and respond to requests for information about the Contract Documents. The Architect's response to such requests will be made in writing within any time limits agreed upon or otherwise with reasonable promptness. If appropriate, the Architect will prepare and issue supplemental Drawings and Specifications in response to the requests for information.

ARTICLE 5 SUBCONTRACTORS

§ 5.1 DEFINITIONS

§ 5.1.1 A Subcontractor is a person or entity who has a direct contract with the Contractor to perform a portion of the Work at the site. The term "Subcontractor" is referred to throughout the Contract Documents as if singular in number and means a Subcontractor or an authorized representative of the Subcontractor. The term "Subcontractor" does not include a separate contractor or subcontractors of a separate contractor.

§ 5.1.2 A Sub-subcontractor is a person or entity who has a direct or indirect contract with a Subcontractor to perform a portion of the Work at the site. The term "Sub-subcontractor" is referred to throughout the Contract Documents as if singular in number and means a Sub-subcontractor or an authorized representative of the Sub-subcontractor.

§ 5.2 AWARD OF SUBCONTRACTS AND OTHER CONTRACTS FOR PORTIONS OF THE WORK

§ 5.2.1 Unless otherwise stated in the Contract Documents or the bidding requirements, the Contractor, as soon as practicable after award of the Contract, shall furnish in writing to the Owner through the Architect the names of persons or entities (including those who are to furnish materials or equipment fabricated to a special design) proposed for each principal portion of the Work. The Architect may reply within 14 days to the Contractor in writing stating (1) whether the Owner or the Architect has reasonable objection to any such proposed person or entity or (2) that the Architect requires additional time for review. Failure of the Owner or Architect to reply within the 14-day period shall constitute notice of no reasonable objection.

§ 5.2.2 The Contractor shall not contract with a proposed person or entity to whom the Owner or Architect has made reasonable and timely objection. The Contractor shall not be required to contract with anyone to whom the Contractor has made reasonable objection.

§ 5.2.3 If the Owner or Architect has reasonable objection to a person or entity proposed by the Contractor, the Contractor shall propose another to whom the Owner or Architect has no reasonable objection. If the proposed but rejected Subcontractor was reasonably capable of performing the Work, the Contract Sum and Contract Time shall be increased or decreased by the difference, if any, occasioned by such change, and an appropriate Change Order shall be issued before commencement of the substitute Subcontractor's Work. However, no increase in the Contract Sum or Contract Time shall be allowed for such change unless the Contractor has acted promptly and responsively in submitting names as required.

§ 5.2.4 The Contractor shall not substitute a Subcontractor, person or entity previously selected if the Owner or Architect makes reasonable objection to such substitution.

§ 5.3 SUBCONTRACTUAL RELATIONS

By appropriate agreement, written where legally required for validity, the Contractor shall require each Subcontractor, to the extent of the Work to be performed by the Subcontractor, to be bound to the Contractor by terms of the Contract Documents, and to assume toward the Contractor all the obligations and responsibilities, including the responsibility for safety of the Subcontractor's Work, which the Contractor, by these Documents, assumes toward the Owner and Architect. Each subcontract agreement shall preserve and protect the rights of the Owner and Architect under the Contract Documents with respect to the Work to be performed by the Subcontractor so that subcontracting thereof will not prejudice such rights, and shall allow to the Subcontractor, unless specifically provided otherwise in the subcontract agreement, the benefit of all rights, remedies and redress against the Contractor that the Contractor, by the Contract Documents, has against the Owner. Where appropriate, the Contractor shall require each Subcontractor to enter into similar agreements with Sub-subcontractors. The Contractor shall make available to each proposed Subcontractor, prior to the execution of the subcontract agreement, copies of the Contract Documents to which the Subcontractor will be bound, and, upon written request of the Subcontractor, identify to the Subcontractor terms and conditions of the proposed subcontract agreement that may be at variance with the Contract Documents. Subcontractors will similarly make copies of applicable portions of such documents available to their respective proposed Sub-subcontractors.

§ 5.4 CONTINGENT ASSIGNMENT OF SUBCONTRACTS

§ 5.4.1 Each subcontract agreement for a portion of the Work is assigned by the Contractor to the Owner, provided that

- .1 assignment is effective only after termination of the Contract by the Owner for cause pursuant to Section 14.2 and only for those subcontract agreements that the Owner accepts by notifying the Subcontractor and Contractor in writing; and
- .2 assignment is subject to the prior rights of the surety, if any, obligated under bond relating to the Contract.

When the Owner accepts the assignment of a subcontract agreement, the Owner assumes the Contractor's rights and obligations under the subcontract.

§ 5.4.2 Upon such assignment, if the Work has been suspended for more than 30 days, the Subcontractor's compensation shall be equitably adjusted for increases in cost resulting from the suspension.

§ 5.4.3 Upon such assignment to the Owner under this Section 5.4, the Owner may further assign the subcontract to a successor contractor or other entity. If the Owner assigns the subcontract to a successor contractor or other entity, the

Init.

Owner shall nevertheless remain legally responsible for all of the successor contractor's obligations under the subcontract.

ARTICLE 6 CONSTRUCTION BY OWNER OR BY SEPARATE CONTRACTORS

§ 6.1 OWNER'S RIGHT TO PERFORM CONSTRUCTION AND TO AWARD SEPARATE CONTRACTS

§ 6.1.1 The Owner reserves the right to perform construction or operations related to the Project with the Owner's own forces, and to award separate contracts in connection with other portions of the Project or other construction or operations on the site under Conditions of the Contract identical or substantially similar to these including those portions related to insurance and waiver of subrogation. If the Contractor claims that delay or additional cost is involved because of such action by the Owner, the Contractor shall make such Claim as provided in Article 15.

§ 6.1.2 When separate contracts are awarded for different portions of the Project or other construction or operations on the site, the term "Contractor" in the Contract Documents in each case shall mean the Contractor who executes each separate Owner-Contractor Agreement.

§ 6.1.3 The Owner shall provide for coordination of the activities of the Owner's own forces and of each separate contractor with the Work of the Contractor, who shall cooperate with them. The Contractor shall participate with other separate contractors and the Owner in reviewing their construction schedules. The Contractor shall make any revisions to the construction schedule deemed necessary after a joint review and mutual agreement. The construction schedules shall then constitute the schedules to be used by the Contractor, separate contractors and the Owner until subsequently revised.

§ 6.1.4 Unless otherwise provided in the Contract Documents, when the Owner performs construction or operations related to the Project with the Owner's own forces, the Owner shall be deemed to be subject to the same obligations and to have the same rights that apply to the Contractor under the Conditions of the Contract, including, without excluding others, those stated in Article 3, this Article 6 and Articles 10, 11 and 12.

§ 6.2 MUTUAL RESPONSIBILITY

§ 6.2.1 The Contractor shall afford the Owner and separate contractors reasonable opportunity for introduction and storage of their materials and equipment and performance of their activities, and shall connect and coordinate the Contractor's construction and operations with theirs as required by the Contract Documents.

§ 6.2.2 If part of the Contractor's Work depends for proper execution or results upon construction or operations by the Owner or a separate contractor, the Contractor shall, prior to proceeding with that portion of the Work, promptly report to the Architect apparent discrepancies or defects in such other construction that would render it unsuitable for such proper execution and results. Failure of the Contractor so to report shall constitute an acknowledgment that the Owner's or separate contractor's completed or partially completed construction is fit and proper to receive the Contractor's Work, except as to defects not then reasonably discoverable.

§ 6.2.3 The Contractor shall reimburse the Owner for costs the Owner incurs that are payable to a separate contractor because of the Contractor's delays, improperly timed activities or defective construction. The Owner shall be responsible to the Contractor for costs the Contractor incurs because of a separate contractor's delays, improperly timed activities, damage to the Work or defective construction.

§ 6.2.4 The Contractor shall promptly remedy damage the Contractor wrongfully causes to completed or partially completed construction or to property of the Owner or separate contractors as provided in Section 10.2.5.

§ 6.2.5 The Owner and each separate contractor shall have the same responsibilities for cutting and patching as are described for the Contractor in Section 3.14.

§ 6.3 OWNER'S RIGHT TO CLEAN UP

If a dispute arises among the Contractor, separate contractors and the Owner as to the responsibility under their respective contracts for maintaining the premises and surrounding area free from waste materials and rubbish, the Owner may clean up and the Architect will allocate the cost among those responsible.

ARTICLE 7 CHANGES IN THE WORK

§ 7.1 GENERAL

§ 7.1.1 Changes in the Work may be accomplished after execution of the Contract, and without invalidating the Contract, by Change Order, Construction Change Directive or order for a minor change in the Work, subject to the limitations stated in this Article 7 and elsewhere in the Contract Documents.

§ 7.1.2 A Change Order shall be based upon agreement among the Owner, Contractor and Architect; a Construction Change Directive requires agreement by the Owner and Architect and may or may not be agreed to by the Contractor; an order for a minor change in the Work may be issued by the Architect alone.

§ 7.1.3 Changes in the Work shall be performed under applicable provisions of the Contract Documents, and the Contractor shall proceed promptly, unless otherwise provided in the Change Order, Construction Change Directive or order for a minor change in the Work.

§ 7.2 CHANGE ORDERS

§ 7.2.1 A Change Order is a written instrument prepared by the Architect and signed by the Owner, Contractor and Architect stating their agreement upon all of the following:

- .1 The change in the Work;
- .2 The amount of the adjustment, if any, in the Contract Sum; and
- .3 The extent of the adjustment, if any, in the Contract Time.

§ 7.3 CONSTRUCTION CHANGE DIRECTIVES

§ 7.3.1 A Construction Change Directive is a written order prepared by the Architect and signed by the Owner and Architect, directing a change in the Work prior to agreement on adjustment, if any, in the Contract Sum or Contract Time, or both. The Owner may by Construction Change Directive, without invalidating the Contract, order changes in the Work within the general scope of the Contract consisting of additions, deletions or other revisions, the Contract Sum and Contract Time being adjusted accordingly.

§ 7.3.2 A Construction Change Directive shall be used in the absence of total agreement on the terms of a Change Order.

§ 7.3.3 If the Construction Change Directive provides for an adjustment to the Contract Sum, the adjustment shall be based on one of the following methods:

- .1 Mutual acceptance of a lump sum properly itemized and supported by sufficient substantiating data to permit evaluation;
- .2 Unit prices stated in the Contract Documents or subsequently agreed upon;
- .3 Cost to be determined in a manner agreed upon by the parties and a mutually acceptable fixed or percentage fee; or
- .4 As provided in Section 7.3.7.

§ 7.3.4 If unit prices are stated in the Contract Documents or subsequently agreed upon, and if quantities originally contemplated are materially changed in a proposed Change Order or Construction Change Directive so that application of such unit prices to quantities of Work proposed will cause substantial inequity to the Owner or Contractor, the applicable unit prices shall be equitably adjusted.

§ 7.3.5 Upon receipt of a Construction Change Directive, the Contractor shall promptly proceed with the change in the Work involved and advise the Architect of the Contractor's agreement or disagreement with the method, if any, provided in the Construction Change Directive for determining the proposed adjustment in the Contract Sum or Contract Time.

§ 7.3.6 A Construction Change Directive signed by the Contractor indicates the Contractor's agreement therewith, including adjustment in Contract Sum and Contract Time or the method for determining them. Such agreement shall be effective immediately and shall be recorded as a Change Order.

§ 7.3.7 If the Contractor does not respond promptly or disagrees with the method for adjustment in the Contract Sum, the Architect shall determine the method and the adjustment on the basis of reasonable expenditures and savings of those performing the Work attributable to the change, including, in case of an increase in the Contract Sum, an amount

Init.

for overhead and profit as set forth in the Agreement, or if no such amount is set forth in the Agreement, a reasonable amount. In such case, and also under Section 7.3.3.3, the Contractor shall keep and present, in such form as the Architect may prescribe, an itemized accounting together with appropriate supporting data. Unless otherwise provided in the Contract Documents, costs for the purposes of this Section 7.3.7 shall be limited to the following:

- .1 Costs of labor, including social security, old age and unemployment insurance, fringe benefits required by agreement or custom, and workers' compensation insurance;
- .2 Costs of materials, supplies and equipment, including cost of transportation, whether incorporated or consumed;
- .3 Rental costs of machinery and equipment, exclusive of hand tools, whether rented from the Contractor or others;
- .4 Costs of premiums for all bonds and insurance, permit fees, and sales, use or similar taxes related to the Work; and
- .5 Additional costs of supervision and field office personnel directly attributable to the change.

§ 7.3.8 The amount of credit to be allowed by the Contractor to the Owner for a deletion or change that results in a net decrease in the Contract Sum shall be actual net cost as confirmed by the Architect. When both additions and credits covering related Work or substitutions are involved in a change, the allowance for overhead and profit shall be figured on the basis of net increase, if any, with respect to that change.

§ 7.3.9 Pending final determination of the total cost of a Construction Change Directive to the Owner, the Contractor may request payment for Work completed under the Construction Change Directive in Applications for Payment. The Architect will make an interim determination for purposes of monthly certification for payment for those costs and certify for payment the amount that the Architect determines, in the Architect's professional judgment, to be reasonably justified. The Architect's interim determination of cost shall adjust the Contract Sum on the same basis as a Change Order, subject to the right of either party to disagree and assert a Claim in accordance with Article 15.

§ 7.3.10 When the Owner and Contractor agree with a determination made by the Architect concerning the adjustments in the Contract Sum and Contract Time, or otherwise reach agreement upon the adjustments, such agreement shall be effective immediately and the Architect will prepare a Change Order. Change Orders may be issued for all or any part of a Construction Change Directive.

§ 7.4 MINOR CHANGES IN THE WORK

The Architect has authority to order minor changes in the Work not involving adjustment in the Contract Sum or extension of the Contract Time and not inconsistent with the intent of the Contract Documents. Such changes will be effected by written order signed by the Architect and shall be binding on the Owner and Contractor.

ARTICLE 8 TIME

§ 8.1 DEFINITIONS

§ 8.1.1 Unless otherwise provided, Contract Time is the period of time, including authorized adjustments, allotted in the Contract Documents for Substantial Completion of the Work.

§ 8.1.2 The date of commencement of the Work is the date established in the Agreement.

§ 8.1.3 The date of Substantial Completion is the date certified by the Architect in accordance with Section 9.8.

§ 8.1.4 The term "day" as used in the Contract Documents shall mean calendar day unless otherwise specifically defined.

§ 8.2 PROGRESS AND COMPLETION

§ 8.2.1 Time limits stated in the Contract Documents are of the essence of the Contract. By executing the Agreement the Contractor confirms that the Contract Time is a reasonable period for performing the Work.

§ 8.2.2 The Contractor shall not knowingly, except by agreement or instruction of the Owner in writing, prematurely commence operations on the site or elsewhere prior to the effective date of insurance required by Article 11 to be furnished by the Contractor and Owner. The date of commencement of the Work shall not be changed by the effective date of such insurance.

§ 8.2.3 The Contractor shall proceed expeditiously with adequate forces and shall achieve Substantial Completion within the Contract Time.

§ 8.3 DELAYS AND EXTENSIONS OF TIME

§ 8.3.1 If the Contractor is delayed at any time in the commencement or progress of the Work by an act or neglect of the Owner or Architect, or of an employee of either, or of a separate contractor employed by the Owner; or by changes ordered in the Work; or by labor disputes, fire, unusual delay in deliveries, unavoidable casualties or other causes beyond the Contractor's control; or by delay authorized by the Owner pending mediation and arbitration; or by other causes that the Architect determines may justify delay, then the Contract Time shall be extended by Change Order for such reasonable time as the Architect may determine.

§ 8.3.2 Claims relating to time shall be made in accordance with applicable provisions of Article 15.

§ 8.3.3 This Section 8.3 does not preclude recovery of damages for delay by either party under other provisions of the Contract Documents.

ARTICLE 9 PAYMENTS AND COMPLETION

§ 9.1 CONTRACT SUM

The Contract Sum is stated in the Agreement and, including authorized adjustments, is the total amount payable by the Owner to the Contractor for performance of the Work under the Contract Documents.

§ 9.2 SCHEDULE OF VALUES

Where the Contract is based on a stipulated sum or Guaranteed Maximum Price, the Contractor shall submit to the Architect, before the first Application for Payment, a schedule of values allocating the entire Contract Sum to the various portions of the Work and prepared in such form and supported by such data to substantiate its accuracy as the Architect may require. This schedule, unless objected to by the Architect, shall be used as a basis for reviewing the Contractor's Applications for Payment.

§ 9.3 APPLICATIONS FOR PAYMENT

§ 9.3.1 At least ten days before the date established for each progress payment, the Contractor shall submit to the Architect an itemized Application for Payment prepared in accordance with the schedule of values, if required under Section 9.2, for completed portions of the Work. Such application shall be notarized, if required, and supported by such data substantiating the Contractor's right to payment as the Owner or Architect may require, such as copies of requisitions from Subcontractors and material suppliers, and shall reflect retainage if provided for in the Contract Documents.

§ 9.3.1.1 As provided in Section 7.3.9, such applications may include requests for payment on account of changes in the Work that have been properly authorized by Construction Change Directives, or by interim determinations of the Architect, but not yet included in Change Orders.

§ 9.3.1.2 Applications for Payment shall not include requests for payment for portions of the Work for which the Contractor does not intend to pay a Subcontractor or material supplier, unless such Work has been performed by others whom the Contractor intends to pay.

§ 9.3.2 Unless otherwise provided in the Contract Documents, payments shall be made on account of materials and equipment delivered and suitably stored at the site for subsequent incorporation in the Work. If approved in advance by the Owner, payment may similarly be made for materials and equipment suitably stored off the site at a location agreed upon in writing. Payment for materials and equipment stored on or off the site shall be conditioned upon compliance by the Contractor with procedures satisfactory to the Owner to establish the Owner's title to such materials and equipment or otherwise protect the Owner's interest, and shall include the costs of applicable insurance, storage and transportation to the site for such materials and equipment stored off the site.

§ 9.3.3 The Contractor warrants that title to all Work covered by an Application for Payment will pass to the Owner no later than the time of payment. The Contractor further warrants that upon submittal of an Application for Payment all Work for which Certificates for Payment have been previously issued and payments received from the Owner shall, to the best of the Contractor's knowledge, information and belief, be free and clear of liens, claims, security interests or

encumbrances in favor of the Contractor, Subcontractors, material suppliers, or other persons or entities making a claim by reason of having provided labor, materials and equipment relating to the Work.

§ 9.4 CERTIFICATES FOR PAYMENT

§ 9.4.1 The Architect will, within seven days after receipt of the Contractor's Application for Payment, either issue to the Owner a Certificate for Payment, with a copy to the Contractor, for such amount as the Architect determines is properly due, or notify the Contractor and Owner in writing of the Architect's reasons for withholding certification in whole or in part as provided in Section 9.5.1.

§ 9.4.2 The issuance of a Certificate for Payment will constitute a representation by the Architect to the Owner, based on the Architect's evaluation of the Work and the data comprising the Application for Payment, that, to the best of the Architect's knowledge, information and belief, the Work has progressed to the point indicated and that the quality of the Work is in accordance with the Contract Documents. The foregoing representations are subject to an evaluation of the Work for conformance with the Contract Documents upon Substantial Completion, to results of subsequent tests and inspections, to correction of minor deviations from the Contract Documents prior to completion and to specific qualifications expressed by the Architect. The issuance of a Certificate for Payment will further constitute a representation that the Contractor is entitled to payment in the amount certified. However, the issuance of a Certificate for Payment will not be a representation that the Architect has (1) made exhaustive or continuous on-site inspections to check the quality or quantity of the Work, (2) reviewed construction means, methods, techniques, sequences or procedures, (3) reviewed copies of requisitions received from Subcontractors and material suppliers and other data requested by the Owner to substantiate the Contractor's right to payment, or (4) made examination to ascertain how or for what purpose the Contractor has used money previously paid on account of the Contract Sum.

§ 9.5 DECISIONS TO WITHHOLD CERTIFICATION

§ 9.5.1 The Architect may withhold a Certificate for Payment in whole or in part, to the extent reasonably necessary to protect the Owner, if in the Architect's opinion the representations to the Owner required by Section 9.4.2 cannot be made. If the Architect is unable to certify payment in the amount of the Application, the Architect will notify the Contractor and Owner as provided in Section 9.4.1. If the Contractor and Architect cannot agree on a revised amount, the Architect will promptly issue a Certificate for Payment for the amount for which the Architect is able to make such representations to the Owner. The Architect may also withhold a Certificate for Payment or, because of subsequently discovered evidence, may nullify the whole or a part of a Certificate for Payment previously issued, to such extent as may be necessary in the Architect's opinion to protect the Owner from loss for which the Contractor is responsible, including loss resulting from acts and omissions described in Section 3.3.2, because of

- .1 defective Work not remedied;
- .2 third party claims filed or reasonable evidence indicating probable filing of such claims unless security acceptable to the Owner is provided by the Contractor;
- .3 failure of the Contractor to make payments properly to Subcontractors or for labor, materials or equipment;
- .4 reasonable evidence that the Work cannot be completed for the unpaid balance of the Contract Sum;
- .5 damage to the Owner or a separate contractor;
- .6 reasonable evidence that the Work will not be completed within the Contract Time, and that the unpaid balance would not be adequate to cover actual or liquidated damages for the anticipated delay; or
- .7 repeated failure to carry out the Work in accordance with the Contract Documents.

§ 9.5.2 When the above reasons for withholding certification are removed, certification will be made for amounts previously withheld.

§ 9.5.3 If the Architect withholds certification for payment under Section 9.5.1.3, the Owner may, at its sole option, issue joint checks to the Contractor and to any Subcontractor or material or equipment suppliers to whom the Contractor failed to make payment for Work properly performed or material or equipment suitably delivered. If the Owner makes payments by joint check, the Owner shall notify the Architect and the Architect will reflect such payment on the next Certificate for Payment.

§ 9.6 PROGRESS PAYMENTS

§ 9.6.1 After the Architect has issued a Certificate for Payment, the Owner shall make payment in the manner and within the time provided in the Contract Documents, and shall so notify the Architect.

Init.

§ 9.6.2 The Contractor shall pay each Subcontractor no later than seven days after receipt of payment from the Owner the amount to which the Subcontractor is entitled, reflecting percentages actually retained from payments to the Contractor on account of the Subcontractor's portion of the Work. The Contractor shall, by appropriate agreement with each Subcontractor, require each Subcontractor to make payments to Sub-subcontractors in a similar manner.

§ 9.6.3 The Architect will, on request, furnish to a Subcontractor, if practicable, information regarding percentages of completion or amounts applied for by the Contractor and action taken thereon by the Architect and Owner on account of portions of the Work done by such Subcontractor.

§ 9.6.4 The Owner has the right to request written evidence from the Contractor that the Contractor has properly paid Subcontractors and material and equipment suppliers amounts paid by the Owner to the Contractor for subcontracted Work. If the Contractor fails to furnish such evidence within seven days, the Owner shall have the right to contact Subcontractors to ascertain whether they have been properly paid. Neither the Owner nor Architect shall have an obligation to pay or to see to the payment of money to a Subcontractor, except as may otherwise be required by law.

§ 9.6.5 Contractor payments to material and equipment suppliers shall be treated in a manner similar to that provided in Sections 9.6.2, 9.6.3 and 9.6.4.

§ 9.6.6 A Certificate for Payment, a progress payment, or partial or entire use or occupancy of the Project by the Owner shall not constitute acceptance of Work not in accordance with the Contract Documents.

§ 9.6.7 Unless the Contractor provides the Owner with a payment bond in the full penal sum of the Contract Sum, payments received by the Contractor for Work properly performed by Subcontractors and suppliers shall be held by the Contractor for those Subcontractors or suppliers who performed Work or furnished materials, or both, under contract with the Contractor for which payment was made by the Owner. Nothing contained herein shall require money to be placed in a separate account and not commingled with money of the Contractor, shall create any fiduciary liability or tort liability on the part of the Contractor for breach of trust or shall entitle any person or entity to an award of punitive damages against the Contractor for breach of the requirements of this provision.

§ 9.7 FAILURE OF PAYMENT

If the Architect does not issue a Certificate for Payment, through no fault of the Contractor, within seven days after receipt of the Contractor's Application for Payment, or if the Owner does not pay the Contractor within seven days after the date established in the Contract Documents the amount certified by the Architect or awarded by binding dispute resolution, then the Contractor may, upon seven additional days' written notice to the Owner and Architect, stop the Work until payment of the amount owing has been received. The Contract Time shall be extended appropriately and the Contract Sum shall be increased by the amount of the Contractor's reasonable costs of shut-down, delay and start-up, plus interest as provided for in the Contract Documents.

§ 9.8 SUBSTANTIAL COMPLETION

§ 9.8.1 Substantial Completion is the stage in the progress of the Work when the Work or designated portion thereof is sufficiently complete in accordance with the Contract Documents so that the Owner can occupy or utilize the Work for its intended use.

§ 9.8.2 When the Contractor considers that the Work, or a portion thereof which the Owner agrees to accept separately, is substantially complete, the Contractor shall prepare and submit to the Architect a comprehensive list of items to be completed or corrected prior to final payment. Failure to include an item on such list does not alter the responsibility of the Contractor to complete all Work in accordance with the Contract Documents.

§ 9.8.3 Upon receipt of the Contractor's list, the Architect will make an inspection to determine whether the Work or designated portion thereof is substantially complete. If the Architect's inspection discloses any item, whether or not included on the Contractor's list, which is not sufficiently complete in accordance with the Contract Documents so that the Owner can occupy or utilize the Work or designated portion thereof for its intended use, the Contractor shall, before issuance of the Certificate of Substantial Completion, complete or correct such item upon notification by the Architect. In such case, the Contractor shall then submit a request for another inspection by the Architect to determine Substantial Completion.

§ 9.8.4 When the Work or designated portion thereof is substantially complete, the Architect will prepare a Certificate of Substantial Completion that shall establish the date of Substantial Completion, shall establish responsibilities of the Owner and Contractor for security, maintenance, heat, utilities, damage to the Work and insurance, and shall fix the time within which the Contractor shall finish all items on the list accompanying the Certificate. Warranties required by the Contract Documents shall commence on the date of Substantial Completion of the Work or designated portion thereof unless otherwise provided in the Certificate of Substantial Completion.

§ 9.8.5 The Certificate of Substantial Completion shall be submitted to the Owner and Contractor for their written acceptance of responsibilities assigned to them in such Certificate. Upon such acceptance and consent of surety, if any, the Owner shall make payment of retainage applying to such Work or designated portion thereof. Such payment shall be adjusted for Work that is incomplete or not in accordance with the requirements of the Contract Documents.

§ 9.9 PARTIAL OCCUPANCY OR USE

§ 9.9.1 The Owner may occupy or use any completed or partially completed portion of the Work at any stage when such portion is designated by separate agreement with the Contractor, provided such occupancy or use is consented to by the insurer as required under Section 11.3.1.5 and authorized by public authorities having jurisdiction over the Project. Such partial occupancy or use may commence whether or not the portion is substantially complete, provided the Owner and Contractor have accepted in writing the responsibilities assigned to each of them for payments, retainage, if any, security, maintenance, heat, utilities, damage to the Work and insurance, and have agreed in writing concerning the period for correction of the Work and commencement of warranties required by the Contract Documents. When the Contractor considers a portion substantially complete, the Contractor shall prepare and submit a list to the Architect as provided under Section 9.8.2. Consent of the Contractor to partial occupancy or use shall not be unreasonably withheld. The stage of the progress of the Work shall be determined by written agreement between the Owner and Contractor or, if no agreement is reached, by decision of the Architect.

§ 9.9.2 Immediately prior to such partial occupancy or use, the Owner, Contractor and Architect shall jointly inspect the area to be occupied or portion of the Work to be used in order to determine and record the condition of the Work.

§ 9.9.3 Unless otherwise agreed upon, partial occupancy or use of a portion or portions of the Work shall not constitute acceptance of Work not complying with the requirements of the Contract Documents.

§ 9.10 FINAL COMPLETION AND FINAL PAYMENT

§ 9.10.1 Upon receipt of the Contractor's written notice that the Work is ready for final inspection and acceptance and upon receipt of a final Application for Payment, the Architect will promptly make such inspection and, when the Architect finds the Work acceptable under the Contract Documents and the Contract fully performed, the Architect will promptly issue a final Certificate for Payment stating that to the best of the Architect's knowledge, information and belief, and on the basis of the Architect's on-site visits and inspections, the Work has been completed in accordance with terms and conditions of the Contract Documents and that the entire balance found to be due the Contractor and noted in the final Certificate is due and payable. The Architect's final Certificate for Payment will constitute a further representation that conditions listed in Section 9.10.2 as precedent to the Contractor's being entitled to final payment have been fulfilled.

§ 9.10.2 Neither final payment nor any remaining retained percentage shall become due until the Contractor submits to the Architect (1) an affidavit that payrolls, bills for materials and equipment, and other indebtedness connected with the Work for which the Owner or the Owner's property might be responsible or encumbered (less amounts withheld by Owner) have been paid or otherwise satisfied, (2) a certificate evidencing that insurance required by the Contract Documents to remain in force after final payment is currently in effect and will not be canceled or allowed to expire until at least 30 days' prior written notice has been given to the Owner, (3) a written statement that the Contractor knows of no substantial reason that the insurance will not be renewable to cover the period required by the Contract Documents, (4) consent of surety, if any, to final payment and (5), if required by the Owner, other data establishing payment or satisfaction of obligations, such as receipts, releases and waivers of liens, claims, security interests or encumbrances arising out of the Contract, to the extent and in such form as may be designated by the Owner. If a Subcontractor refuses to furnish a release or waiver required by the Owner, the Contractor may furnish a bond satisfactory to the Owner to indemnify the Owner against such lien. If such lien remains unsatisfied after payments are made, the Contractor shall refund to the Owner all money that the Owner may be compelled to pay in discharging such lien, including all costs and reasonable attorneys' fees.

§ 9.10.3 If, after Substantial Completion of the Work, final completion thereof is materially delayed through no fault of the Contractor or by issuance of Change Orders affecting final completion, and the Architect so confirms, the Owner shall, upon application by the Contractor and certification by the Architect, and without terminating the Contract, make payment of the balance due for that portion of the Work fully completed and accepted. If the remaining balance for Work not fully completed or corrected is less than retainage stipulated in the Contract Documents, and if bonds have been furnished, the written consent of surety to payment of the balance due for that portion of the Work fully completed and accepted shall be submitted by the Contractor to the Architect prior to certification of such payment. Such payment shall be made under terms and conditions governing final payment, except that it shall not constitute a waiver of claims.

§ 9.10.4 The making of final payment shall constitute a waiver of Claims by the Owner except those arising from

- .1 liens, Claims, security interests or encumbrances arising out of the Contract and unsettled;
- .2 failure of the Work to comply with the requirements of the Contract Documents; or
- .3 terms of special warranties required by the Contract Documents.

§ 9.10.5 Acceptance of final payment by the Contractor, a Subcontractor or material supplier shall constitute a waiver of claims by that payee except those previously made in writing and identified by that payee as unsettled at the time of final Application for Payment.

ARTICLE 10 PROTECTION OF PERSONS AND PROPERTY

§ 10.1 SAFETY PRECAUTIONS AND PROGRAMS

The Contractor shall be responsible for initiating, maintaining and supervising all safety precautions and programs in connection with the performance of the Contract.

§ 10.2 SAFETY OF PERSONS AND PROPERTY

§ 10.2.1 The Contractor shall take reasonable precautions for safety of, and shall provide reasonable protection to prevent damage, injury or loss to

- .1 employees on the Work and other persons who may be affected thereby;
- .2 the Work and materials and equipment to be incorporated therein, whether in storage on or off the site, under care, custody or control of the Contractor or the Contractor's Subcontractors or Sub-subcontractors; and
- .3 other property at the site or adjacent thereto, such as trees, shrubs, lawns, walks, pavements, roadways, structures and utilities not designated for removal, relocation or replacement in the course of construction.

§ 10.2.2 The Contractor shall comply with and give notices required by applicable laws, statutes, ordinances, codes, rules and regulations, and lawful orders of public authorities bearing on safety of persons or property or their protection from damage, injury or loss.

§ 10.2.3 The Contractor shall erect and maintain, as required by existing conditions and performance of the Contract, reasonable safeguards for safety and protection, including posting danger signs and other warnings against hazards, promulgating safety regulations and notifying owners and users of adjacent sites and utilities.

§ 10.2.4 When use or storage of explosives or other hazardous materials or equipment or unusual methods are necessary for execution of the Work, the Contractor shall exercise utmost care and carry on such activities under supervision of properly qualified personnel.

§ 10.2.5 The Contractor shall promptly remedy damage and loss (other than damage or loss insured under property insurance required by the Contract Documents) to property referred to in Sections 10.2.1.2 and 10.2.1.3 caused in whole or in part by the Contractor, a Subcontractor, a Sub-subcontractor, or anyone directly or indirectly employed by any of them, or by anyone for whose acts they may be liable and for which the Contractor is responsible under Sections 10.2.1.2 and 10.2.1.3, except damage or loss attributable to acts or omissions of the Owner or Architect or anyone directly or indirectly employed by either of them, or by anyone for whose acts either of them may be liable, and not attributable to the fault or negligence of the Contractor. The foregoing obligations of the Contractor are in addition to the Contractor's obligations under Section 3.18.

Init.

§ 10.2.6 The Contractor shall designate a responsible member of the Contractor's organization at the site whose duty shall be the prevention of accidents. This person shall be the Contractor's superintendent unless otherwise designated by the Contractor in writing to the Owner and Architect.

§ 10.2.7 The Contractor shall not permit any part of the construction or site to be loaded so as to cause damage or create an unsafe condition.

§ 10.2.8 INJURY OR DAMAGE TO PERSON OR PROPERTY

If either party suffers injury or damage to person or property because of an act or omission of the other party, or of others for whose acts such party is legally responsible, written notice of such injury or damage, whether or not insured, shall be given to the other party within a reasonable time not exceeding 21 days after discovery. The notice shall provide sufficient detail to enable the other party to investigate the matter.

§ 10.3 HAZARDOUS MATERIALS

§ 10.3.1 The Contractor is responsible for compliance with any requirements included in the Contract Documents regarding hazardous materials. If the Contractor encounters a hazardous material or substance not addressed in the Contract Documents and if reasonable precautions will be inadequate to prevent foreseeable bodily injury or death to persons resulting from a material or substance, including but not limited to asbestos or polychlorinated biphenyl (PCB), encountered on the site by the Contractor, the Contractor shall, upon recognizing the condition, immediately stop Work in the affected area and report the condition to the Owner and Architect in writing.

§ 10.3.2 Upon receipt of the Contractor's written notice, the Owner shall obtain the services of a licensed laboratory to verify the presence or absence of the material or substance reported by the Contractor and, in the event such material or substance is found to be present, to cause it to be rendered harmless. Unless otherwise required by the Contract Documents, the Owner shall furnish in writing to the Contractor and Architect the names and qualifications of persons or entities who are to perform tests verifying the presence or absence of such material or substance or who are to perform the task of removal or safe containment of such material or substance. The Contractor and the Architect will promptly reply to the Owner in writing stating whether or not either has reasonable objection to the persons or entities proposed by the Owner. If either the Contractor or Architect has an objection to a person or entity proposed by the Owner, the Owner shall propose another to whom the Contractor and the Architect have no reasonable objection. When the material or substance has been rendered harmless, Work in the affected area shall resume upon written agreement of the Owner and Contractor. By Change Order, the Contract Time shall be extended appropriately and the Contract Sum shall be increased in the amount of the Contractor's reasonable additional costs of shut-down, delay and start-up.

§ 10.3.3 To the fullest extent permitted by law, the Owner shall indemnify and hold harmless the Contractor, Subcontractors, Architect, Architect's consultants and agents and employees of any of them from and against claims, damages, losses and expenses, including but not limited to attorneys' fees, arising out of or resulting from performance of the Work in the affected area if in fact the material or substance presents the risk of bodily injury or death as described in Section 10.3.1 and has not been rendered harmless, provided that such claim, damage, loss or expense is attributable to bodily injury, sickness, disease or death, or to injury to or destruction of tangible property (other than the Work itself), except to the extent that such damage, loss or expense is due to the fault or negligence of the party seeking indemnity.

§ 10.3.4 The Owner shall not be responsible under this Section 10.3 for materials or substances the Contractor brings to the site unless such materials or substances are required by the Contract Documents. The Owner shall be responsible for materials or substances required by the Contract Documents, except to the extent of the Contractor's fault or negligence in the use and handling of such materials or substances.

§ 10.3.5 The Contractor shall indemnify the Owner for the cost and expense the Owner incurs (1) for remediation of a material or substance the Contractor brings to the site and negligently handles, or (2) where the Contractor fails to perform its obligations under Section 10.3.1, except to the extent that the cost and expense are due to the Owner's fault or negligence.

§ 10.3.6 If, without negligence on the part of the Contractor, the Contractor is held liable by a government agency for the cost of remediation of a hazardous material or substance solely by reason of performing Work as required by the Contract Documents, the Owner shall indemnify the Contractor for all cost and expense thereby incurred.

Init.

§ 10.4 EMERGENCIES

In an emergency affecting safety of persons or property, the Contractor shall act, at the Contractor's discretion, to prevent threatened damage, injury or loss. Additional compensation or extension of time claimed by the Contractor on account of an emergency shall be determined as provided in Article 15 and Article 7.

ARTICLE 11 INSURANCE AND BONDS

§ 11.1 CONTRACTOR'S LIABILITY INSURANCE

§ 11.1.1 The Contractor shall purchase from and maintain in a company or companies lawfully authorized to do business in the jurisdiction in which the Project is located such insurance as will protect the Contractor from claims set forth below which may arise out of or result from the Contractor's operations and completed operations under the Contract and for which the Contractor may be legally liable, whether such operations be by the Contractor or by a Subcontractor or by anyone directly or indirectly employed by any of them, or by anyone for whose acts any of them may be liable:

- .1 Claims under workers' compensation, disability benefit and other similar employee benefit acts that are applicable to the Work to be performed;
- .2 Claims for damages because of bodily injury, occupational sickness or disease, or death of the Contractor's employees;
- .3 Claims for damages because of bodily injury, sickness or disease, or death of any person other than the Contractor's employees;
- .4 Claims for damages insured by usual personal injury liability coverage;
- .5 Claims for damages, other than to the Work itself, because of injury to or destruction of tangible property, including loss of use resulting therefrom;
- .6 Claims for damages because of bodily injury, death of a person or property damage arising out of ownership, maintenance or use of a motor vehicle;
- .7 Claims for bodily injury or property damage arising out of completed operations; and
- .8 Claims involving contractual liability insurance applicable to the Contractor's obligations under Section 3.18.

§ 11.1.2 The insurance required by Section 11.1.1 shall be written for not less than limits of liability specified in the Contract Documents or required by law, whichever coverage is greater. Coverages, whether written on an occurrence or claims-made basis, shall be maintained without interruption from the date of commencement of the Work until the date of final payment and termination of any coverage required to be maintained after final payment, and, with respect to the Contractor's completed operations coverage, until the expiration of the period for correction of Work or for such other period for maintenance of completed operations coverage as specified in the Contract Documents.

§ 11.1.3 Certificates of insurance acceptable to the Owner shall be filed with the Owner prior to commencement of the Work and thereafter upon renewal or replacement of each required policy of insurance. These certificates and the insurance policies required by this Section 11.1 shall contain a provision that coverages afforded under the policies will not be canceled or allowed to expire until at least 30 days' prior written notice has been given to the Owner. An additional certificate evidencing continuation of liability coverage, including coverage for completed operations, shall be submitted with the final Application for Payment as required by Section 9.10.2 and thereafter upon renewal or replacement of such coverage until the expiration of the time required by Section 11.1.2. Information concerning reduction of coverage on account of revised limits or claims paid under the General Aggregate, or both, shall be furnished by the Contractor with reasonable promptness.

§ 11.1.4 The Contractor shall cause the commercial liability coverage required by the Contract Documents to include (1) the Owner, the Architect and the Architect's consultants as additional insureds for claims caused in whole or in part by the Contractor's negligent acts or omissions during the Contractor's operations; and (2) the Owner as an additional insured for claims caused in whole or in part by the Contractor's negligent acts or omissions during the Contractor's completed operations.

§ 11.2 OWNER'S LIABILITY INSURANCE

The Owner shall be responsible for purchasing and maintaining the Owner's usual liability insurance.

§ 11.3 PROPERTY INSURANCE

§ 11.3.1 Unless otherwise provided, the Owner shall purchase and maintain, in a company or companies lawfully authorized to do business in the jurisdiction in which the Project is located, property insurance written on a builder's risk "all-risk" or equivalent policy form in the amount of the initial Contract Sum, plus value of subsequent Contract Modifications and cost of materials supplied or installed by others, comprising total value for the entire Project at the site on a replacement cost basis without optional deductibles. Such property insurance shall be maintained, unless otherwise provided in the Contract Documents or otherwise agreed in writing by all persons and entities who are beneficiaries of such insurance, until final payment has been made as provided in Section 9.10 or until no person or entity other than the Owner has an insurable interest in the property required by this Section 11.3 to be covered, whichever is later. This insurance shall include interests of the Owner, the Contractor, Subcontractors and Sub-subcontractors in the Project.

§ 11.3.1.1 Property insurance shall be on an "all-risk" or equivalent policy form and shall include, without limitation, insurance against the perils of fire (with extended coverage) and physical loss or damage including, without duplication of coverage, theft, vandalism, malicious mischief, collapse, earthquake, flood, windstorm, falsework, testing and startup, temporary buildings and debris removal including demolition occasioned by enforcement of any applicable legal requirements, and shall cover reasonable compensation for Architect's and Contractor's services and expenses required as a result of such insured loss.

§ 11.3.1.2 If the Owner does not intend to purchase such property insurance required by the Contract and with all of the coverages in the amount described above, the Owner shall so inform the Contractor in writing prior to commencement of the Work. The Contractor may then effect insurance that will protect the interests of the Contractor, Subcontractors and Sub-subcontractors in the Work, and by appropriate Change Order the cost thereof shall be charged to the Owner. If the Contractor is damaged by the failure or neglect of the Owner to purchase or maintain insurance as described above, without so notifying the Contractor in writing, then the Owner shall bear all reasonable costs properly attributable thereto.

§ 11.3.1.3 If the property insurance requires deductibles, the Owner shall pay costs not covered because of such deductibles.

§ 11.3.1.4 This property insurance shall cover portions of the Work stored off the site, and also portions of the Work in transit.

§ 11.3.1.5 Partial occupancy or use in accordance with Section 9.9 shall not commence until the insurance company or companies providing property insurance have consented to such partial occupancy or use by endorsement or otherwise. The Owner and the Contractor shall take reasonable steps to obtain consent of the insurance company or companies and shall, without mutual written consent, take no action with respect to partial occupancy or use that would cause cancellation, lapse or reduction of insurance.

§ 11.3.2 BOILER AND MACHINERY INSURANCE

The Owner shall purchase and maintain boiler and machinery insurance required by the Contract Documents or by law, which shall specifically cover such insured objects during installation and until final acceptance by the Owner; this insurance shall include interests of the Owner, Contractor, Subcontractors and Sub-subcontractors in the Work, and the Owner and Contractor shall be named insureds.

§ 11.3.3 LOSS OF USE INSURANCE

The Owner, at the Owner's option, may purchase and maintain such insurance as will insure the Owner against loss of use of the Owner's property due to fire or other hazards, however caused. The Owner waives all rights of action against the Contractor for loss of use of the Owner's property, including consequential losses due to fire or other hazards however caused.

§ 11.3.4 If the Contractor requests in writing that insurance for risks other than those described herein or other special causes of loss be included in the property insurance policy, the Owner shall, if possible, include such insurance, and the cost thereof shall be charged to the Contractor by appropriate Change Order.

§ 11.3.5 If during the Project construction period the Owner insures properties, real or personal or both, at or adjacent to the site by property insurance under policies separate from those insuring the Project, or if after final payment

Init.

property insurance is to be provided on the completed Project through a policy or policies other than those insuring the Project during the construction period, the Owner shall waive all rights in accordance with the terms of Section 11.3.7 for damages caused by fire or other causes of loss covered by this separate property insurance. All separate policies shall provide this waiver of subrogation by endorsement or otherwise.

§ 11.3.6 Before an exposure to loss may occur, the Owner shall file with the Contractor a copy of each policy that includes insurance coverages required by this Section 11.3. Each policy shall contain all generally applicable conditions, definitions, exclusions and endorsements related to this Project. Each policy shall contain a provision that the policy will not be canceled or allowed to expire, and that its limits will not be reduced, until at least 30 days' prior written notice has been given to the Contractor.

§ 11.3.7 WAIVERS OF SUBROGATION

The Owner and Contractor waive all rights against (1) each other and any of their subcontractors, sub-subcontractors, agents and employees, each of the other, and (2) the Architect, Architect's consultants, separate contractors described in Article 6, if any, and any of their subcontractors, sub-subcontractors, agents and employees, for damages caused by fire or other causes of loss to the extent covered by property insurance obtained pursuant to this Section 11.3 or other property insurance applicable to the Work, except such rights as they have to proceeds of such insurance held by the Owner as fiduciary. The Owner or Contractor, as appropriate, shall require of the Architect, Architect's consultants, separate contractors described in Article 6, if any, and the subcontractors, sub-subcontractors, agents and employees of any of them, by appropriate agreements, written where legally required for validity, similar waivers each in favor of other parties enumerated herein. The policies shall provide such waivers of subrogation by endorsement or otherwise. A waiver of subrogation shall be effective as to a person or entity even though that person or entity would otherwise have a duty of indemnification, contractual or otherwise, did not pay the insurance premium directly or indirectly, and whether or not the person or entity had an insurable interest in the property damaged.

§ 11.3.8 A loss insured under the Owner's property insurance shall be adjusted by the Owner as fiduciary and made payable to the Owner as fiduciary for the insureds, as their interests may appear, subject to requirements of any applicable mortgagee clause and of Section 11.3.10. The Contractor shall pay Subcontractors their just shares of insurance proceeds received by the Contractor, and by appropriate agreements, written where legally required for validity, shall require Subcontractors to make payments to their Sub-subcontractors in similar manner.

§ 11.3.9 If required in writing by a party in interest, the Owner as fiduciary shall, upon occurrence of an insured loss, give bond for proper performance of the Owner's duties. The cost of required bonds shall be charged against proceeds received as fiduciary. The Owner shall deposit in a separate account proceeds so received, which the Owner shall distribute in accordance with such agreement as the parties in interest may reach, or as determined in accordance with the method of binding dispute resolution selected in the Agreement between the Owner and Contractor. If after such loss no other special agreement is made and unless the Owner terminates the Contract for convenience, replacement of damaged property shall be performed by the Contractor after notification of a Change in the Work in accordance with Article 7.

§ 11.3.10 The Owner as fiduciary shall have power to adjust and settle a loss with insurers unless one of the parties in interest shall object in writing within five days after occurrence of loss to the Owner's exercise of this power; if such objection is made, the dispute shall be resolved in the manner selected by the Owner and Contractor as the method of binding dispute resolution in the Agreement. If the Owner and Contractor have selected arbitration as the method of binding dispute resolution, the Owner as fiduciary shall make settlement with insurers or, in the case of a dispute over distribution of insurance proceeds, in accordance with the directions of the arbitrators.

§ 11.4 PERFORMANCE BOND AND PAYMENT BOND

§ 11.4.1 The Owner shall have the right to require the Contractor to furnish bonds covering faithful performance of the Contract and payment of obligations arising thereunder as stipulated in bidding requirements or specifically required in the Contract Documents on the date of execution of the Contract.

§ 11.4.2 Upon the request of any person or entity appearing to be a potential beneficiary of bonds covering payment of obligations arising under the Contract, the Contractor shall promptly furnish a copy of the bonds or shall authorize a copy to be furnished.

Init.

ARTICLE 12 UNCOVERING AND CORRECTION OF WORK

§ 12.1 UNCOVERING OF WORK

§ 12.1.1 If a portion of the Work is covered contrary to the Architect's request or to requirements specifically expressed in the Contract Documents, it must, if requested in writing by the Architect, be uncovered for the Architect's examination and be replaced at the Contractor's expense without change in the Contract Time.

§ 12.1.2 If a portion of the Work has been covered that the Architect has not specifically requested to examine prior to its being covered, the Architect may request to see such Work and it shall be uncovered by the Contractor. If such Work is in accordance with the Contract Documents, costs of uncovering and replacement shall, by appropriate Change Order, be at the Owner's expense. If such Work is not in accordance with the Contract Documents, such costs and the cost of correction shall be at the Contractor's expense unless the condition was caused by the Owner or a separate contractor in which event the Owner shall be responsible for payment of such costs.

§ 12.2 CORRECTION OF WORK

§ 12.2.1 BEFORE OR AFTER SUBSTANTIAL COMPLETION

The Contractor shall promptly correct Work rejected by the Architect or failing to conform to the requirements of the Contract Documents, whether discovered before or after Substantial Completion and whether or not fabricated, installed or completed. Costs of correcting such rejected Work, including additional testing and inspections, the cost of uncovering and replacement, and compensation for the Architect's services and expenses made necessary thereby, shall be at the Contractor's expense.

§ 12.2.2 AFTER SUBSTANTIAL COMPLETION

§ 12.2.2.1 In addition to the Contractor's obligations under Section 3.5, if, within one year after the date of Substantial Completion of the Work or designated portion thereof or after the date for commencement of warranties established under Section 9.9.1, or by terms of an applicable special warranty required by the Contract Documents, any of the Work is found to be not in accordance with the requirements of the Contract Documents, the Contractor shall correct it promptly after receipt of written notice from the Owner to do so unless the Owner has previously given the Contractor a written acceptance of such condition. The Owner shall give such notice promptly after discovery of the condition. During the one-year period for correction of Work, if the Owner fails to notify the Contractor and give the Contractor an opportunity to make the correction, the Owner waives the rights to require correction by the Contractor and to make a claim for breach of warranty. If the Contractor fails to correct nonconforming Work within a reasonable time during that period after receipt of notice from the Owner or Architect, the Owner may correct it in accordance with Section 2.4.

§ 12.2.2.2 The one-year period for correction of Work shall be extended with respect to portions of Work first performed after Substantial Completion by the period of time between Substantial Completion and the actual completion of that portion of the Work.

§ 12.2.2.3 The one-year period for correction of Work shall not be extended by corrective Work performed by the Contractor pursuant to this Section 12.2.

§ 12.2.3 The Contractor shall remove from the site portions of the Work that are not in accordance with the requirements of the Contract Documents and are neither corrected by the Contractor nor accepted by the Owner.

§ 12.2.4 The Contractor shall bear the cost of correcting destroyed or damaged construction, whether completed or partially completed, of the Owner or separate contractors caused by the Contractor's correction or removal of Work that is not in accordance with the requirements of the Contract Documents.

§ 12.2.5 Nothing contained in this Section 12.2 shall be construed to establish a period of limitation with respect to other obligations the Contractor has under the Contract Documents. Establishment of the one-year period for correction of Work as described in Section 12.2.2 relates only to the specific obligation of the Contractor to correct the Work, and has no relationship to the time within which the obligation to comply with the Contract Documents may be sought to be enforced, nor to the time within which proceedings may be commenced to establish the Contractor's liability with respect to the Contractor's obligations other than specifically to correct the Work.

§ 12.3 ACCEPTANCE OF NONCONFORMING WORK

If the Owner prefers to accept Work that is not in accordance with the requirements of the Contract Documents, the Owner may do so instead of requiring its removal and correction, in which case the Contract Sum will be reduced as appropriate and equitable. Such adjustment shall be effected whether or not final payment has been made.

ARTICLE 13 MISCELLANEOUS PROVISIONS

§ 13.1 GOVERNING LAW

The Contract shall be governed by the law of the place where the Project is located except that, if the parties have selected arbitration as the method of binding dispute resolution, the Federal Arbitration Act shall govern Section 15.4.

§ 13.2 SUCCESSORS AND ASSIGNS

§ 13.2.1 The Owner and Contractor respectively bind themselves, their partners, successors, assigns and legal representatives to covenants, agreements and obligations contained in the Contract Documents. Except as provided in Section 13.2.2, neither party to the Contract shall assign the Contract as a whole without written consent of the other. If either party attempts to make such an assignment without such consent, that party shall nevertheless remain legally responsible for all obligations under the Contract.

§ 13.2.2 The Owner may, without consent of the Contractor, assign the Contract to a lender providing construction financing for the Project, if the lender assumes the Owner's rights and obligations under the Contract Documents. The Contractor shall execute all consents reasonably required to facilitate such assignment.

§ 13.3 WRITTEN NOTICE

Written notice shall be deemed to have been duly served if delivered in person to the individual, to a member of the firm or entity, or to an officer of the corporation for which it was intended; or if delivered at, or sent by registered or certified mail or by courier service providing proof of delivery to, the last business address known to the party giving notice.

§ 13.4 RIGHTS AND REMEDIES

§ 13.4.1 Duties and obligations imposed by the Contract Documents and rights and remedies available thereunder shall be in addition to and not a limitation of duties, obligations, rights and remedies otherwise imposed or available by law.

§ 13.4.2 No action or failure to act by the Owner, Architect or Contractor shall constitute a waiver of a right or duty afforded them under the Contract, nor shall such action or failure to act constitute approval of or acquiescence in a breach there under, except as may be specifically agreed in writing.

§ 13.5 TESTS AND INSPECTIONS

§ 13.5.1 Tests, inspections and approvals of portions of the Work shall be made as required by the Contract Documents and by applicable laws, statutes, ordinances, codes, rules and regulations or lawful orders of public authorities. Unless otherwise provided, the Contractor shall make arrangements for such tests, inspections and approvals with an independent testing laboratory or entity acceptable to the Owner, or with the appropriate public authority, and shall bear all related costs of tests, inspections and approvals. The Contractor shall give the Architect timely notice of when and where tests and inspections are to be made so that the Architect may be present for such procedures. The Owner shall bear costs of (1) tests, inspections or approvals that do not become requirements until after bids are received or negotiations concluded, and (2) tests, inspections or approvals where building codes or applicable laws or regulations prohibit the Owner from delegating their cost to the Contractor.

§ 13.5.2 If the Architect, Owner or public authorities having jurisdiction determine that portions of the Work require additional testing, inspection or approval not included under Section 13.5.1, the Architect will, upon written authorization from the Owner, instruct the Contractor to make arrangements for such additional testing, inspection or approval by an entity acceptable to the Owner, and the Contractor shall give timely notice to the Architect of when and where tests and inspections are to be made so that the Architect may be present for such procedures. Such costs, except as provided in Section 13.5.3, shall be at the Owner's expense.

§ 13.5.3 If such procedures for testing, inspection or approval under Sections 13.5.1 and 13.5.2 reveal failure of the portions of the Work to comply with requirements established by the Contract Documents, all costs made necessary by

Init.

such failure including those of repeated procedures and compensation for the Architect's services and expenses shall be at the Contractor's expense.

§ 13.5.4 Required certificates of testing, inspection or approval shall, unless otherwise required by the Contract Documents, be secured by the Contractor and promptly delivered to the Architect.

§ 13.5.5 If the Architect is to observe tests, inspections or approvals required by the Contract Documents, the Architect will do so promptly and, where practicable, at the normal place of testing.

§ 13.5.6 Tests or inspections conducted pursuant to the Contract Documents shall be made promptly to avoid unreasonable delay in the Work.

§ 13.6 INTEREST

Payments due and unpaid under the Contract Documents shall bear interest from the date payment is due at such rate as the parties may agree upon in writing or, in the absence thereof, at the legal rate prevailing from time to time at the place where the Project is located.

§ 13.7 TIME LIMITS ON CLAIMS

The Owner and Contractor shall commence all claims and causes of action, whether in contract, tort, breach of warranty or otherwise, against the other arising out of or related to the Contract in accordance with the requirements of the final dispute resolution method selected in the Agreement within the time period specified by applicable law, but in any case not more than 10 years after the date of Substantial Completion of the Work. The Owner and Contractor waive all claims and causes of action not commenced in accordance with this Section 13.7.

ARTICLE 14 TERMINATION OR SUSPENSION OF THE CONTRACT

§ 14.1 TERMINATION BY THE CONTRACTOR

§ 14.1.1 The Contractor may terminate the Contract if the Work is stopped for a period of 30 consecutive days through no act or fault of the Contractor or a Subcontractor, Sub-subcontractor or their agents or employees or any other persons or entities performing portions of the Work under direct or indirect contract with the Contractor, for any of the following reasons:

- .1 Issuance of an order of a court or other public authority having jurisdiction that requires all Work to be stopped;
- .2 An act of government, such as a declaration of national emergency that requires all Work to be stopped;
- .3 Because the Architect has not issued a Certificate for Payment and has not notified the Contractor of the reason for withholding certification as provided in Section 9.4.1, or because the Owner has not made payment on a Certificate for Payment within the time stated in the Contract Documents; or
- .4 The Owner has failed to furnish to the Contractor promptly, upon the Contractor's request, reasonable evidence as required by Section 2.2.1.

§ 14.1.2 The Contractor may terminate the Contract if, through no act or fault of the Contractor or a Subcontractor, Sub-subcontractor or their agents or employees or any other persons or entities performing portions of the Work under direct or indirect contract with the Contractor, repeated suspensions, delays or interruptions of the entire Work by the Owner as described in Section 14.3 constitute in the aggregate more than 100 percent of the total number of days scheduled for completion, or 120 days in any 365-day period, whichever is less.

§ 14.1.3 If one of the reasons described in Section 14.1.1 or 14.1.2 exists, the Contractor may, upon seven days' written notice to the Owner and Architect, terminate the Contract and recover from the Owner payment for Work executed, including reasonable overhead and profit, costs incurred by reason of such termination, and damages.

§ 14.1.4 If the Work is stopped for a period of 60 consecutive days through no act or fault of the Contractor or a Subcontractor or their agents or employees or any other persons performing portions of the Work under contract with the Contractor because the Owner has repeatedly failed to fulfill the Owner's obligations under the Contract Documents with respect to matters important to the progress of the Work, the Contractor may, upon seven additional days' written notice to the Owner and the Architect, terminate the Contract and recover from the Owner as provided in Section 14.1.3.

§ 14.2 TERMINATION BY THE OWNER FOR CAUSE

§ 14.2.1 The Owner may terminate the Contract if the Contractor

- .1 repeatedly refuses or fails to supply enough properly skilled workers or proper materials;
- .2 fails to make payment to Subcontractors for materials or labor in accordance with the respective agreements between the Contractor and the Subcontractors;
- .3 repeatedly disregards applicable laws, statutes, ordinances, codes, rules and regulations, or lawful orders of a public authority; or
- .4 otherwise is guilty of substantial breach of a provision of the Contract Documents.

§ 14.2.2 When any of the above reasons exist, the Owner, upon certification by the Initial Decision Maker that sufficient cause exists to justify such action, may without prejudice to any other rights or remedies of the Owner and after giving the Contractor and the Contractor's surety, if any, seven days' written notice, terminate employment of the Contractor and may, subject to any prior rights of the surety:

- .1 Exclude the Contractor from the site and take possession of all materials, equipment, tools, and construction equipment and machinery thereon owned by the Contractor;
- .2 Accept assignment of subcontracts pursuant to Section 5.4; and
- .3 Finish the Work by whatever reasonable method the Owner may deem expedient. Upon written request of the Contractor, the Owner shall furnish to the Contractor a detailed accounting of the costs incurred by the Owner in finishing the Work.

§ 14.2.3 When the Owner terminates the Contract for one of the reasons stated in Section 14.2.1, the Contractor shall not be entitled to receive further payment until the Work is finished.

§ 14.2.4 If the unpaid balance of the Contract Sum exceeds costs of finishing the Work, including compensation for the Architect's services and expenses made necessary thereby, and other damages incurred by the Owner and not expressly waived, such excess shall be paid to the Contractor. If such costs and damages exceed the unpaid balance, the Contractor shall pay the difference to the Owner. The amount to be paid to the Contractor or Owner, as the case may be, shall be certified by the Initial Decision Maker, upon application, and this obligation for payment shall survive termination of the Contract.

§ 14.3 SUSPENSION BY THE OWNER FOR CONVENIENCE

§ 14.3.1 The Owner may, without cause, order the Contractor in writing to suspend, delay or interrupt the Work in whole or in part for such period of time as the Owner may determine.

§ 14.3.2 The Contract Sum and Contract Time shall be adjusted for increases in the cost and time caused by suspension, delay or interruption as described in Section 14.3.1. Adjustment of the Contract Sum shall include profit. No adjustment shall be made to the extent

- .1 that performance is, was or would have been so suspended, delayed or interrupted by another cause for which the Contractor is responsible; or
- .2 that an equitable adjustment is made or denied under another provision of the Contract.

§ 14.4 TERMINATION BY THE OWNER FOR CONVENIENCE

§ 14.4.1 The Owner may, at any time, terminate the Contract for the Owner's convenience and without cause.

§ 14.4.2 Upon receipt of written notice from the Owner of such termination for the Owner's convenience, the Contractor shall

- .1 cease operations as directed by the Owner in the notice;
- .2 take actions necessary, or that the Owner may direct, for the protection and preservation of the Work; and
- .3 except for Work directed to be performed prior to the effective date of termination stated in the notice, terminate all existing subcontracts and purchase orders and enter into no further subcontracts and purchase orders.

§ 14.4.3 In case of such termination for the Owner's convenience, the Contractor shall be entitled to receive payment for Work executed, and costs incurred by reason of such termination, along with reasonable overhead and profit on the Work not executed.

Init.

ARTICLE 15 CLAIMS AND DISPUTES

§ 15.1 CLAIMS

§ 15.1.1 DEFINITION

A Claim is a demand or assertion by one of the parties seeking, as a matter of right, payment of money, or other relief with respect to the terms of the Contract. The term "Claim" also includes other disputes and matters in question between the Owner and Contractor arising out of or relating to the Contract. The responsibility to substantiate Claims shall rest with the party making the Claim.

§ 15.1.2 NOTICE OF CLAIMS

Claims by either the Owner or Contractor must be initiated by written notice to the other party and to the Initial Decision Maker with a copy sent to the Architect, if the Architect is not serving as the Initial Decision Maker. Claims by either party must be initiated within 21 days after occurrence of the event giving rise to such Claim or within 21 days after the claimant first recognizes the condition giving rise to the Claim, whichever is later.

§ 15.1.3 CONTINUING CONTRACT PERFORMANCE

Pending final resolution of a Claim, except as otherwise agreed in writing or as provided in Section 9.7 and Article 14, the Contractor shall proceed diligently with performance of the Contract and the Owner shall continue to make payments in accordance with the Contract Documents. The Architect will prepare Change Orders and issue Certificates for Payment in accordance with the decisions of the Initial Decision Maker.

§ 15.1.4 CLAIMS FOR ADDITIONAL COST

If the Contractor wishes to make a Claim for an increase in the Contract Sum, written notice as provided herein shall be given before proceeding to execute the Work. Prior notice is not required for Claims relating to an emergency endangering life or property arising under Section 10.4.

§ 15.1.5 CLAIMS FOR ADDITIONAL TIME

§ 15.1.5.1 If the Contractor wishes to make a Claim for an increase in the Contract Time, written notice as provided herein shall be given. The Contractor's Claim shall include an estimate of cost and of probable effect of delay on progress of the Work. In the case of a continuing delay, only one Claim is necessary.

§ 15.1.5.2 If adverse weather conditions are the basis for a Claim for additional time, such Claim shall be documented by data substantiating that weather conditions were abnormal for the period of time, could not have been reasonably anticipated and had an adverse effect on the scheduled construction.

§ 15.1.6 CLAIMS FOR CONSEQUENTIAL DAMAGES

The Contractor and Owner waive Claims against each other for consequential damages arising out of or relating to this Contract. This mutual waiver includes

- .1 damages incurred by the Owner for rental expenses, for losses of use, income, profit, financing, business and reputation, and for loss of management or employee productivity or of the services of such persons; and
- .2 damages incurred by the Contractor for principal office expenses including the compensation of personnel stationed there, for losses of financing, business and reputation, and for loss of profit except anticipated profit arising directly from the Work.

This mutual waiver is applicable, without limitation, to all consequential damages due to either party's termination in accordance with Article 14. Nothing contained in this Section 15.1.6 shall be deemed to preclude an award of liquidated damages, when applicable, in accordance with the requirements of the Contract Documents.

§ 15.2 INITIAL DECISION

§ 15.2.1 Claims, excluding those arising under Sections 10.3, 10.4, 11.3.9, and 11.3.10, shall be referred to the Initial Decision Maker for initial decision. The Architect will serve as the Initial Decision Maker, unless otherwise indicated in the Agreement. Except for those Claims excluded by this Section 15.2.1, an initial decision shall be required as a condition precedent to mediation of any Claim arising prior to the date final payment is due, unless 30 days have passed after the Claim has been referred to the Initial Decision Maker with no decision having been rendered. Unless the Initial Decision Maker and all affected parties agree, the Initial Decision Maker will not decide disputes between the Contractor and persons or entities other than the Owner.

Init.

§ 15.2.2 The Initial Decision Maker will review Claims and within ten days of the receipt of a Claim take one or more of the following actions: (1) request additional supporting data from the claimant or a response with supporting data from the other party, (2) reject the Claim in whole or in part, (3) approve the Claim, (4) suggest a compromise, or (5) advise the parties that the Initial Decision Maker is unable to resolve the Claim if the Initial Decision Maker lacks sufficient information to evaluate the merits of the Claim or if the Initial Decision Maker concludes that, in the Initial Decision Maker's sole discretion, it would be inappropriate for the Initial Decision Maker to resolve the Claim.

§ 15.2.3 In evaluating Claims, the Initial Decision Maker may, but shall not be obligated to, consult with or seek information from either party or from persons with special knowledge or expertise who may assist the Initial Decision Maker in rendering a decision. The Initial Decision Maker may request the Owner to authorize retention of such persons at the Owner's expense.

§ 15.2.4 If the Initial Decision Maker requests a party to provide a response to a Claim or to furnish additional supporting data, such party shall respond, within ten days after receipt of such request, and shall either (1) provide a response on the requested supporting data, (2) advise the Initial Decision Maker when the response or supporting data will be furnished or (3) advise the Initial Decision Maker that no supporting data will be furnished. Upon receipt of the response or supporting data, if any, the Initial Decision Maker will either reject or approve the Claim in whole or in part.

§ 15.2.5 The Initial Decision Maker will render an initial decision approving or rejecting the Claim, or indicating that the Initial Decision Maker is unable to resolve the Claim. This initial decision shall (1) be in writing; (2) state the reasons therefor; and (3) notify the parties and the Architect, if the Architect is not serving as the Initial Decision Maker, of any change in the Contract Sum or Contract Time or both. The initial decision shall be final and binding on the parties but subject to mediation and, if the parties fail to resolve their dispute through mediation, to binding dispute resolution.

§ 15.2.6 Either party may file for mediation of an initial decision at any time, subject to the terms of Section 15.2.6.1.

§ 15.2.6.1 Either party may, within 30 days from the date of an initial decision, demand in writing that the other party file for mediation within 60 days of the initial decision. If such a demand is made and the party receiving the demand fails to file for mediation within the time required, then both parties waive their rights to mediate or pursue binding dispute resolution proceedings with respect to the initial decision.

§ 15.2.7 In the event of a Claim against the Contractor, the Owner may, but is not obligated to, notify the surety, if any, of the nature and amount of the Claim. If the Claim relates to a possibility of a Contractor's default, the Owner may, but is not obligated to, notify the surety and request the surety's assistance in resolving the controversy.

§ 15.2.8 If a Claim relates to or is the subject of a mechanic's lien, the party asserting such Claim may proceed in accordance with applicable law to comply with the lien notice or filing deadlines.

§ 15.3 MEDIATION

§ 15.3.1 Claims, disputes, or other matters in controversy arising out of or related to the Contract except those waived as provided for in Sections 9.10.4, 9.10.5, and 15.1.6 shall be subject to mediation as a condition precedent to binding dispute resolution.

§ 15.3.2 The parties shall endeavor to resolve their Claims by mediation which, unless the parties mutually agree otherwise, shall be administered by the American Arbitration Association in accordance with its Construction Industry Mediation Procedures in effect on the date of the Agreement. A request for mediation shall be made in writing, delivered to the other party to the Contract, and filed with the person or entity administering the mediation. The request may be made concurrently with the filing of binding dispute resolution proceedings but, in such event, mediation shall proceed in advance of binding dispute resolution proceedings, which shall be stayed pending mediation for a period of 60 days from the date of filing, unless stayed for a longer period by agreement of the parties or court order. If an arbitration is stayed pursuant to this Section 15.3.2, the parties may nonetheless proceed to the selection of the arbitrator(s) and agree upon a schedule for later proceedings.

§ 15.3.3 The parties shall share the mediator's fee and any filing fees equally. The mediation shall be held in the place where the Project is located, unless another location is mutually agreed upon. Agreements reached in mediation shall be enforceable as settlement agreements in any court having jurisdiction thereof.

§ 15.4 ARBITRATION

§ 15.4.1 If the parties have selected arbitration as the method for binding dispute resolution in the Agreement, any Claim subject to, but not resolved by, mediation shall be subject to arbitration which, unless the parties mutually agree otherwise, shall be administered by the American Arbitration Association in accordance with its Construction Industry Arbitration Rules in effect on the date of the Agreement. A demand for arbitration shall be made in writing, delivered to the other party to the Contract, and filed with the person or entity administering the arbitration. The party filing a notice of demand for arbitration must assert in the demand all Claims then known to that party on which arbitration is permitted to be demanded.

§ 15.4.1.1 A demand for arbitration shall be made no earlier than concurrently with the filing of a request for mediation, but in no event shall it be made after the date when the institution of legal or equitable proceedings based on the Claim would be barred by the applicable statute of limitations. For statute of limitations purposes, receipt of a written demand for arbitration by the person or entity administering the arbitration shall constitute the institution of legal or equitable proceedings based on the Claim.

§ 15.4.2 The award rendered by the arbitrator or arbitrators shall be final, and judgment may be entered upon it in accordance with applicable law in any court having jurisdiction thereof.

§ 15.4.3 The foregoing agreement to arbitrate and other agreements to arbitrate with an additional person or entity duly consented to by parties to the Agreement shall be specifically enforceable under applicable law in any court having jurisdiction thereof.

§ 15.4.4 CONSOLIDATION OR JOINDER

§ 15.4.4.1 Either party, at its sole discretion, may consolidate an arbitration conducted under this Agreement with any other arbitration to which it is a party provided that (1) the arbitration agreement governing the other arbitration permits consolidation, (2) the arbitrations to be consolidated substantially involve common questions of law or fact, and (3) the arbitrations employ materially similar procedural rules and methods for selecting arbitrator(s).

§ 15.4.4.2 Either party, at its sole discretion, may include by joinder persons or entities substantially involved in a common question of law or fact whose presence is required if complete relief is to be accorded in arbitration, provided that the party sought to be joined consents in writing to such joinder. Consent to arbitration involving an additional person or entity shall not constitute consent to arbitration of any claim, dispute or other matter in question not described in the written consent.

§ 15.4.4.3 The Owner and Contractor grant to any person or entity made a party to an arbitration conducted under this Section 15.4, whether by joinder or consolidation, the same rights of joinder and consolidation as the Owner and Contractor under this Agreement.

SECTION 00 73 00 – SUPPLEMENTAL GENERAL CONDITIONS

The following supplements modify the "General Conditions of the Contract for Construction," AIA Document A201, Fifteenth Edition, 2007. Where a portion of the General Conditions is modified or deleted by these Supplementary Conditions, the unaltered portions of the General Conditions shall remain in effect.

ARTICLE 1 - GENERAL PROVISIONS

Add the following sub-paragraphs to 1.1:

- 1.1.1.1 The proposed Bidding Documents also include the Rhode Island Judicial Purchasing Rules and Regulations and General Terms and Conditions of Purchase along with any Judicial Purchasing Orders issued for the Project.
- 1.1.9 Miscellaneous Definitions
 - 1.1.9.1 The term "product" includes materials, systems and equipment.
 - 1.1.9.2 Where "as directed," "as permitted," "as required," "approved," "acceptance," or words of similar import are used, it shall be understood that the direction, requirement, permission, approval or acceptance of the Architect is intended, unless stated otherwise. As used herein, "provide" shall be understood to mean "provide complete in place" that is, "furnish and install."

1.2 Correlation and Intent of the Contract Documents

Add the following Clause 1.2.3.1 to 1.2.3:

- 1.2.3.1 The following are all part of the Contract Documents and in the event of conflicts or discrepancies among the Contract Documents, interpretations will be based on the following priorities.
 1. The Agreement.
 2. Addenda, with those of a later date having precedence over those of an earlier date.
 3. The Supplementary Conditions.
 4. The General Conditions of the Contract for Construction.
 5. Specifications.
 6. Rhode Island Judicial Purchasing Rules and Regulations, the General Terms and Conditions of Purchase, and any Judicial Purchase Order issued for the Project.

Add the following sub-paragraph 1.2.4:

- 1.2.4 Sections of Division 1- General Requirements govern the execution of all Sections of the Specifications.

ARTICLE 2 – OWNER

2.1.1 Contact Person: Stephen J. Kerr, Asst. State Court Administrator for Facilities, Operations and Security, Rhode Island Supreme Court, 250 Benefit Street, Providence, RI 02903, 401-222-4999.

2.2 Information and Services Required of the Owner

Delete sub-paragraph 2.2.1 without substitution.

Delete sub-paragraph 2.2.2 and substitute the following:

- 2.2.2 The Contractor shall secure and pay for permits and fees, and necessary approvals, easements, assessments and charges required for construction, use or occupancy of permanent structures or for permanent changes in existing facilities.

Delete sub-paragraph 2.2.5 and substitute the following:

- 2.2.5 The Contractor will be furnished, free of charge, one CD of the Drawings and Project Manual. The Contractor shall be responsible for all printing of construction documents and associated costs.

ARTICLE 3 - CONTRACTOR

3.2 Review of Contract Documents and Field Conditions by Contractor

Add the following sub-paragraph to 3.2:

- 3.2.5 Failure of the Specifications to indicate the need for items to properly perform the Work of the Project, such as attachments, bolts, hangers, and other fastening devices, shall not relieve the Contractor from furnishing and installing these items.
- 3.2.6 Should an inconsistency (or discrepancy) be found in the Contract Documents not clarified by addendum, the better quality or greater quantity of Work shall be provided in accordance with the Architect's interpretation.

Add the following sub-paragraph to 3.3:

- 3.3.4 If the Contractor determines that the Work already performed is not in proper condition to receive subsequent Work, the Contractor shall immediately take all steps necessary to ensure that the proper condition is achieved so that the Work can proceed.

3.4 Labor and Materials

Delete sub-paragraph 3.4.2 and substitute the following:

- 3.4.2 The Contractor may make substitutions only with the written consent of the Owner, after evaluation by the Architect and in accordance with a properly executed Change Order.

Add the following sub-paragraphs 3.4.4 and 3.4.5 to 3.4:

- 3.4.4 After execution of the Contract, the Owner and the Architect shall only consider formal written requests for the substitution of products specified in and in accordance with the the General Requirements (Division 1 of the Specifications) and in Article 7 (CHANGES IN THE WORK) of this document.
- 3.4.5 By making requests for substitutions based on sub-paragraph 3.4.3 above, the Contractor:

- .1 Represents that the Contractor has personally investigated the proposed substitute product and determined that it is equal or superior in all respects to the product specified;
- .2 Represents that the Contractor will provide the same warranty for the proposed substitute product that the Contractor would for the product specified;
- .3 Certifies that the cost data presented is complete and accurate and includes only those costs directly related to this Contract and excludes any redesign costs of the Architect; and
- .4 Will coordinate the installation of the accepted substitute, making such changes as may be required for the Work to be complete in all respects.

3.6 Taxes

Delete sub-paragraph 3.6. and substitute the following:

- 3.6 The Owner is exempt from payment of sales taxes for materials directly incorporated into the Work of this Project. Refer to requirements set forth in the General Requirements (Division 1 of the Specifications).

3.7 Permits, Fees and Notices

Add to sub-paragraph 3.7.1:

- .1 The Contractor shall contact the Rhode Island State Building Commissioner to determine the amount of permit costs and associated fees or surcharges, if any such permits are needed for the Project.

3.9 SUPERINTENDENT

Add the following to sub-paragraph 3.9.2:

- 3.9.2 The Contractor shall provide the Owner and the Architect with the Superintendent's name and contact information.

ARTICLE 4 – ARCHITECT

Delete sub-paragraph 4.1.2 and substitute the following:

- 4.1.2 Duties, responsibilities and limitations of authority of the Architect as set forth in the Contract Documents shall not be restricted, modified or extended without written consent of the Owner and Architect. Consent shall not be unreasonably withheld.

Delete sub-paragraph 4.1.3 and substitute the following:

- 4.1.3 If the employment of the Architect is terminated, the Owner has the option to employ another Architect whose status under the Contract Documents shall be that of the former Architect.

ARTICLE 7 - CHANGES IN THE WORK

7.3 Construction Change Directives

Delete sub-paragraph 7.3.6 and substitute the following:

7.3.6 If a cost is not previously agreed upon, then the Contractor, provided he receives a Construction Change Directive signed by the Owner, shall promptly proceed with the Work involved. The cost of such Work shall then be determined by the Architect on the basis of the reasonable expenditures and savings of those performing the Work attributable to the change, including in the case of an increase in the Contract Sum, an allowance for overhead and profit as stipulated in 7.3.10. In such cases, the Contractor shall keep and present, in such form as the Architect may prescribe, an itemized accounting together with appropriate supporting data for inclusion in a Change Order. Pending final determination of cost to the Owner, payments on account shall be made on the Architect's Certificate for Payment.

Add the following sub-paragraph to 7.3.10:

- 7.3.10 In sub-paragraph 7.3.3 and 7.3.6 the allowance for overhead and profit combined, included in the total cost to the Owner, shall be based on the following schedule:
- .1 For the Contractor, for any Work performed by the Contractor's own forces, ten percent (10%) of the cost.
 - .2 For the Contractor, for Work performed by the Sub-subcontractor, five percent (5%) of the amount due the Subcontractor.
 - .3 For each Subcontractor or Sub-subcontractor involved, for any Work performed by that Subcontractor's own forces, ten percent (10%) of the cost.
 - .4 For each Subcontractor, for Work performed by Subcontractors of the Sub-subcontractor five percent (5%) of the amount due the Subcontractor.
 - .5 Cost to which overhead and profit is to be applied shall be determined in accordance with Subparagraph 7.3.11.
 - .6 In order to facilitate checking of quotations for extras or credits, all proposals, except those so minor (Less than fifty dollars), shall be accompanied by a complete itemization of costs including labor, materials and subcontracts. Labor and materials shall be itemized in the manner described the above sections (.1 - .4). In no case will a change over fifty dollars (\$50.00) be approved without such itemization.
- 7.3.11 Cost, as referred to throughout Article 7, shall be limited to the following costs directly attributable to the change: cost of materials, including cost of delivery; cost of labor, including social security and unemployment insurance, fringe benefits required by agreement or custom; Workmen's compensation insurance; rental value of tools (excluding small/hand tools), equipment and machinery.
- 7.3.12 Overhead, as referred to throughout Article 7, shall include the following expenses directly attributable to the change: cost of bond and insurance premiums, additional cost of supervision and superintendence, wages of time-keepers, watchmen and clerks, small/hand tools, incidentals, general office expense, and all other expenses directly attributable to the change and not included in "Cost".
- 7.3.13 The amount of any credit to the Owner for a deletion or change which results in a net decrease in the Contract Sum will be in the amount of the actual net cost as confirmed by the Architect. When both additions and credits covering related Work or substitutions are involved in any one change, the allowance for overhead and profit shall be figured on the basis of the net increase, if any, with respect to that change.
- 7.3.14 Subsequent to the approval of a Change Order, whether involving a change in Contract Sum, contract time or both, no additional claim related to that change will be considered by the Owner. A change incorporated into a Change Order is

therefore all inclusive, and includes such factors as Project impact, schedule "ripple" effect or other items which may pertain to such change.

ARTICLE 9 - PAYMENTS AND COMPLETION

9.3 Application for Payment

Add the following sentences to sub-paragraph 9.3.1:

The form of Application for Payment shall be a notarized AIA Document G702, Application and Certification for Payment, supported by AIA Document G703, Continuation Sheet.

9.4 Certificate for Payment

Add the following new sub-paragraphs:

9.4.3 First Certificate for Payment - The Architect will process the first Certificate for Payment only after receipt of: 1). the information required for Article 7 of the Instructions to Bidders; 2). certification from the Contractor that it is maintaining current Record Drawings

9.4.4 Second and Subsequent Certificates for Payment - The Architect will process the second and subsequent Certificates for Payment only after receipt of: 1). certification that the Contractor is maintaining current Record Drawings, 2). Release of Liens, 3). all the proposed material and color samples and selections have been submitted for the Architect's approval. The Architect will not process any Certificates for Payment without certification from the Contractor that the Record Drawings are current and without having received all Release of Liens forms.

9.5 Decisions to Withhold Certification

Add the following Clause .8 to 9.5.1:

.8 Failure to maintain current Record Drawings.

9.6 Progress Payments

Add the following to sub-paragraph 9.6.1:

9.6.1 Based upon Applications for Payment submitted to the Architect by the Contractor and Certificates for Payment issued by the Architect, the Owner shall make progress payments on account of the Contract Sum to the Contractor as provided in the Contract Documents for the period ending the last day of the month as follows:

Payments shall be made not more than once per month. Ninety percent (90%) of the portion of the Contract Sum properly allocatable to labor, materials and equipment incorporated in the Work and ninety percent (90%) of the portion of the Contract Sum properly allocable to materials and equipment suitably stored at the site or at some other location agreed upon in writing, for the period covered by the Application for Payment, less the aggregate of previous payments made by the Owner; and upon Substantial Completion of the entire Work, a sum sufficient to increase the total payments to ninety-seven percent (97%) of the Contract Sum, less such amounts as the Architect shall determine for all incomplete Work and unsettled claims as provided in the Contract Documents. If in the opinion of the Architect, the Work progresses satisfactorily after fifty percent (50%) of the Work is completed, the Architect may recommend to the Owner that the retainage be decreased to five

percent (5%). Such reduction shall occur upon the Owner's approval and after receipt of AIA Document G707A (Consent of Surety to Reduction).

Add the following sub-paragraph to 9.6.1:

9.6.1.1 The Owner reserves the right to withhold payment to the Contractor, in whole or in part, for any or all of the reasons cited in Clauses 9.5.1.1 through 9.5.1.8.

9.7 Failure of Payment

Delete paragraph 9.7 and substitute the following:

If the Architect does not issue a Certificate for Payment, through no fault of the Contractor, within seven (7) days after receipt of the Contractor's Application for Payment, or if the Owner does not pay the Contractor within thirty (30) days after the date established in the Contract Documents, the amount certified by the Architect or awarded by binding dispute resolution, then the Contractor may, upon ten (10) additional days' written notice to the Owner and the Architect, stop Work until payment of the amount owing has been received. The Contract Time shall be extended appropriately and the Contract Sum shall be increased by the Amount of the Contractor's reasonable costs of shutdown, delay and start-up, plus interest as provided for in the Contract Documents.

9.8 Substantial Completion

Add the following sentence to sub-paragraph 9.8.4:

Prior to the issuance of a Certificate of Substantial Completion, and in addition to requirements herein, the Contractor and his subcontractors shall submit: 1). their respective certificates of Contract Document compliance; 2). all warranties and guarantees; 3). bonds; 4). all certifications and affidavits; 5). operating manuals, report of Owner instructions, and test results; 6). Project record documents, including Record Drawings; 7). extra materials and samples (as specified) required for Owner; and 8). any permits, including occupancy permit (if requested), and notices.

9.10 Final Completion and Final Payment

9.10.2 Add the following sentence:

The Contractor shall submit AIA Document G706, Contractor's Affidavit of Payment of Debts and Claims, and G706A, Contractor's Affidavit of Release of Liens, to satisfy number the affidavits required by (1) above, and AIA Document G707, Consent of Surety Company to Final Payment, to satisfy the consent required by number (4) above.

Add the following sub-paragraphs:

9.10.6 Certificates for Payment seeking final payment by the Contractor will not be processed unless and until Architect has received from the Contractor Release of Lien forms from all subcontractors and material suppliers indicating that they have been paid in full for all Work covered by prior Certificates for Payment.

9.10.7 The Contractor shall immediately satisfy all liens or encumbrances which, because of any act or default of the Contractor is filed against the premises, and shall indemnify and hold the Owner harmless against any and all claims (including without

limitation subrogation claims), loss, liability, damages, costs, and expenses (including without limitation court costs and legal fees), of any kind whatsoever, and any and all legal actions including third-party actions, cross-actions, and/or claims for contribution and/or indemnity with respect to any claims by any person, entity, and/or party, which relate to or arise out of the Project. In addition, moneys due under the Contract may be retained by the Owner until all such suits, claims for damages or expenses as aforesaid shall have been settled and paid.

- 9.10.8 The statement on the Standard AIA Form G702, Certificates of Payment, which certifies that "all bills are paid for which previous certificates for payment were issued" shall be notarized by a Notary Public currently licensed in the State of Rhode Island.

ARTICLE 11 - INSURANCE AND BONDS

11.1 Contractor's Liability Insurance

- 11.1.1 Replace the words "in a company or companies lawfully authorized to do business in the jurisdiction in which the Project is located" insert the words "in a company or companies licensed to do business in the State of Rhode Island and to which the Owner has no reasonable objection."

Add the following sub-paragraphs to 11.1.1:

- .9 Liability Insurance shall include all major divisions of coverage and be on a comprehensive basis including:
1. Premises Operations (including X-C/U as applicable).
 2. Independent Contractor's Protective.
 3. Products and Completed Operations.
 4. Personal Injury Liability with Employment Exclusion deleted.
 5. Contractual-including specified provisions for Contractor's obligation under Paragraph 3.18.
 6. Owned, non-owned and hired motor vehicles.
 7. Broad Form Property Damage including completed operations including explosion, collapse, and underground.
- .10 If the General Liability coverages are provided by a General Liability Policy on a claims-made basis, the policy Retroactive Date shall predate the Contract; the termination date of the policy or applicable extended reporting period shall be no earlier than the termination date of coverages required to be maintained after final payment, certified in accordance with subparagraph 9.10.2.

Add the following sub-paragraph to 11.1.2:

- 11.1.2 Add the following sentence:

The Owner shall be named as an additional insured on the insurance required by Section 11.1.1 and the coverage shall include liability arising out of completed operations and shall provide coverage for the sole negligence of the Owner as an additional insured.

- 11.1.2.1 The insurance required by sub-paragraph 11.1.1 shall be written for not less than the following limits, or greater if required by law:

1. Worker's Compensation:
 - (a) State: Statutory
 - (b) Employer's Liability: \$500,000

2. Comprehensive General Liability (including Premises Operations; Independent Contractor's Protective; Products and Completed Operations; Broad Form Property Damage):
 - (a) Bodily Injury:

\$1,000,000.	Each Person
\$1,000,000.	Each Occurrence
\$1,000,000.	Annual Aggregate
 - (b) Property Damage:

\$500,000.	Each Occurrence
\$1,000,000.	Annual Aggregate
 - (c) Products and Completed Operations to be maintained for one (1) year after final payment.
 - (d) Property Damage Liability Insurance shall provide X,C or U coverage as applicable.

3. Contractual Liability:
 - (a) Bodily Injury:

\$1,000,000.	Each Occurrence
--------------	--------------------
 - (b) Property Damage:

\$1,000,000.	Each Occurrence
\$1,000,000.	Annual Aggregate

4. Personal Injury, with Employment Exclusion deleted:

\$1,000,000.	Annual Aggregate
--------------	---------------------

5. Comprehensive Automobile Liability:
 - (a) Bodily Injury:

\$500,000.	Each Person
\$1,000,000.	Each Occurrence
 - (b) Property Damage:

\$500,000.	Each Occurrence
------------	--------------------

Add the following sub-paragraph to 11.1.3:

- 11.1.3.1 The Contractor shall provide the Owner with one (1) Certificate of Insurance reflecting the Owner as an additional insured for all insurance required in Article 11

no later than forty-eight (48) hours prior to commencement of any Work on the Project. If the Contractor's Liability Insurance is written on the Comprehensive General Liability policy form, the Certificates shall be AIA Document G705, Certificate of Insurance. If this insurance is written on a Commercial General Liability policy form, ACCORD for 25S will be acceptable. The Contractor shall provide the Owner with copies of endorsements with each Certificate of Insurance evidencing the Owner's additional insured status, waivers of subrogation waiving any right to recovery the insurance company may have against the Owner, and showing that the requisite coverage remains on each policy. Any deductible or self-insured retention amount or other similar obligation under any of the policies required under Article 11 shall be the sole responsibility of the Contractor.

11.2 Owner's Liability Insurance

Delete the sub-paragraph 11.2 in its entirety.

11.3 Property Insurance

Delete sub-paragraph 11.3.1 in its entirety and substitute the following:

11.3.1 The Contractor shall purchase and maintain, in a company or companies licensed to do business in the State of Rhode Island, property insurance for the entire Work at the site in the amount of the initial Contract Sum, plus value of subsequent Contract . Such insurance shall be in a company or companies against which the Owner has no reasonable objection. The Owner, the Contractor, Subcontractors and Sub-subcontractors shall all be listed as additional insureds and said insurance shall protect against the perils of fire and extended coverage and shall include "all risk" insurance for physical loss or damage including, without duplication of coverage theft, vandalism, and malicious mischief. The Contractor shall also purchase and maintain this type of property insurance on portions of the Work stored offsite or in transit when such portions of the Work are to be included in an Application for Payment under sub-paragraph 9.3.2 and such portions of the work would not otherwise be covered under the "all risk" insurance policy required above and/or such insurance is otherwise required by the Contract Documents. Forty eight (48) hours before the commencement of the Work, the Contractor shall furnish the Owner with Certificates of Insurance and copies of endorsements proving that such coverage exists.

Add the following sentence to Clause 11.3.1.1:

11.3.1.1 The form of policy for this coverage shall be Completed Value.

11.3.1.2 Delete Clause 11.3.1.2.

11.3.1.3 Delete Clause 11.3.1.3.

11.3.2 Delete Sub-paragraph 11.3.2.

11.3.3 Delete Sub-paragraph 11.3.3.

11.3.4 Delete Sub-paragraph 11.3.4.

Delete sub-paragraph 11.3.6 in its entirety and substitute the following:

11.3.6 The Contractor shall file two (2) certified copies of all policies required under Article 11 with the Owner forty eight (48) hours prior to the commencement of the Work.

Each policy shall contain all generally applicable conditions, definitions, exclusions and endorsements related to this Project. Each policy shall contain a provision that the policy and endorsements may not be cancelled, modified, or allowed to expire without at least thirty (30) days prior written notice to the Owner. The failure to provide the requisite insurance is a material breach of contract entitling the Owner to immediately terminate its agreement with the Contractor. If the Owner is damaged by the failure of the Contractor to maintain the requisite insurance and to so notify the Owner, then the Contractor shall bear all reasonable costs properly attributable thereto.

- 11.3.7 Modify sub-paragraph 11.3.7 substituting "Contractor" for "Owner" as fiduciary at the end of the first sentence.
- 11.3.8 Modify sub-paragraph 11.3.8 by substituting "Contractor" for "Owner" as fiduciary; except that at the first reference to "Owner" in the first sentence, the word "this" should be substituted for "Owner's".
- 11.3.9 Modify sub-paragraph 11.3.9 by substituting "Contractor" for "Owner" each time the latter word appears except in the last sentence (only the Owner can terminate for convenience).
- 11.3.10 Modify sub-paragraph 11.3.10 by substituting "Contractor" for "Owner" each time the latter word appears.

Delete sub-paragraph 11.4.1 and substitute the following:

- 11.4.1 The Contractor shall furnish bonds covering faithful performance of the Contract and payment of obligations arising thereunder. Bonds must be secured through a surety company licensed to do business in the State of Rhode Island and the cost thereof shall be included in the Contract Sum. The amount of each bond shall be equal to one hundred percent (100%) of the Contract Sum.
- 11.4.1.1 The Contractor shall deliver the required bonds to the Owner on or before the date the Agreement is executed.

11.4 Performance Bond and Payment Bond

Add the following sentence:

11.4.3 The Contractor shall require the attorney-in-fact who executes the required bonds on behalf of the surety to affix thereto a certified and current copy of the power of attorney.

ARTICLE 12 - UNCOVERING AND CORRECTION OF WORK

Acceptance of Nonconforming Work

Add the following sentence to 12.3.1:

Acceptance by the Owner of any nonconforming Work must be in writing.

ARTICLE 13 - MISCELLANEOUS PROVISIONS

13.6 Interest

Add the following clause to the end of 13.6:

and as otherwise permitted by law.

Add the following paragraph 13.8 to Article 13:

13.8 Equal Opportunity

13.8.1 The Contractor shall maintain policies of employment as follows:

13.8.1.1 The Contractor and the Contractor's Subcontractors shall not discriminate against any employee or applicant for employment because of race, religion, color, sex or national origin. The Contractor shall take affirmative action to insure that applicants are employed, and that employees are treated during employment without regard to their race, religion, color, sex or national origin.

Such action shall include, but not be limited to, the following: employment, upgrading, demotion or transfer; recruitment or recruitment advertising; layoff or termination; rates of pay or other forms of compensation; and selection for training, including apprenticeship. The Contractor agrees to post in conspicuous places, available to employees and applicants for employment, notices setting forth the policies of nondiscrimination.

13.8.1.2 The Contractor and the Contractor's Subcontractor's shall, in all solicitations or advertisements for employees placed by them or on their behalf, state that all qualified applicants will receive consideration for employment without regard to race, religion, color, sex or national origin.

13.8.1.3 The Contractor shall be a signatory to the requirements of the Rhode Island Equal Employment Office.

Add the following paragraph 13.9 to Article 13:

13.9 Prevailing Wage Schedules on Public Works Projects

13.9.1 In accordance with the General Laws of Rhode Island the Department of Labor determined the customary and prevailing rate of wages paid to craftspersons, teamsters, and laborers in the constructing of public Works by the State, and by cities and towns, and by persons contracting therewith for such construction. Violators are subject to fine of not more than One Hundred Dollars (\$100.00) for each offense.

13.9.2 The wage rates as ascertained by the Department of Labor are uniform for the State of Rhode Island and as of the date of advertisement of Contract applying to the life of the Contract. Information concerning wage rates prevailing in the construction industry in Rhode Island may be obtained from the Office of the State Department of Labor, 220 Elmwood Avenue, Providence, Rhode Island. Under no condition shall the wages paid on this Project be less than those designated in the general classification. This clause does not relieve the Contractor or his Subcontractors from respecting any other union regulations to which he ordinarily subscribes.

13.9.3 Bulletin No. 3, State Labor Laws, issued by the Rhode Island Department of Labor, pertaining to Public Works Projects (General laws of Rhode Island, Revision of 1956, Chapter 37-12 as amended, and Chapter 77, Public Laws of 1965), are hereby made a part of this Project. These laws include, but are not limited to:

- .1 Weekly payment of employees;
- .2 Provisions applicable to public Works contracts;
- .3 Payment of prevailing wage rates;
- .4 Posting of prevailing wage rates and;
- .5 Overtime compensation.

ARTICLE 14 – TERMINATION OR SUSPENSION OF THE CONTRACT

Delete clause 14.1.1.4 in its entirety.

Delete sub-paragraph 14.2.1.4 and substitute the following:

- 14.2.1.4 otherwise fails to satisfactorily fulfill or perform any obligations, promises, terms, or conditions of the Contract Documents.

Delete paragraph 14.2.3 and insert the following:

- 14.2.3 When the Owner terminates the Contract for one of the reasons stated in Section 14.2.1, the Contractor shall not be entitled to receive further payment.

Add the following sentence to clause 14.2.4

- 14.2.4 Such payment does not limit other damages recoverable by the Owner at law.

14.4 Termination by the Owner for Convenience

Delete sub-paragraph 14.4.3 and substitute the following:

- 14.4.3 Within thirty (30) days of the effective date of the termination of the contract by the Owner, the Contractor shall submit to the Architect an Application for Payment for any unpaid Work performed up to the date of termination. Such application shall proceed in the ordinary course as provided herein.

ARTICLE 15 – CLAIMS AND DISPUTES

15.4 ARBITRATION

Delete section 15.4 entitled ARBITRATION in its entirety and all references to arbitration in "AIA General Conditions, A201, 2007" and substitute the following:

Arbitration shall be in accordance with the provisions of the State Arbitration laws (State of Rhode Island, General Laws, Title 37, Chapter 16), which shall take precedence and shall govern.

ARTICLE 16 - SPECIAL PROJECT WORK CONDITIONS

16.1 Coordination

- A. Prior to commencement of subcontract Work, a designated representative of each subcontractor shall meet with the Project superintendent and Owner's Representative at the site and at the time set by the Owner's Representative to discuss requirements and the scope of Work.
- B. The General Contractor and all subcontractors will be required to attend a preconstruction conference at a date and time set by the Owner's Representative.

16.2 Behavior of Personnel

- A. If in the opinion of the Owner's Representative, any employee of the Contractor, a subcontractor and/or a sub-subcontractor is physically or mentally unfit for Work or exhibits behavior incompatible with Work site environment, said employee may be required to leave the property and may be refused re-admittance.
- B. Employees of the Contractor, subcontractor and/or sub-subcontractor shall abide by the State's drug-free workplace policy and shall so attest upon request by the Owner by signing a certificate of compliance.
- C. Employees of the Contractor, subcontractor and/or sub-subcontractor shall be familiar with special regulations, policies and procedures in effect at the site and comply with such rules, including but not limited to security policies or practices and/or criminal background checks.
- D. At all times while Work is performed at the site at least one employee of the Contractor, subcontractor and sub-subcontractor shall have a good command of the English language and must be able to effectively communicate with the Owner and its staff.
- E. Employees of the Contractor, subcontractor and/or sub-subcontractor shall not disclose any confidential information of the Owner to any third party. Confidential information means: (1) any information of a sensitive or proprietary nature, whether or not specially identified as confidential or proprietary; or (2) any information about the Owner gained during the performance of a contract that is not already lawfully in the public domain.

16.3 Substitutions

- A. In all cases where a proprietary designation is used in connection with materials or articles to be furnished under this contract and the phrase "or equal" is not used, the Contractor shall furnish the specified item, unless a written request for a substitute has been submitted by the Contractor and written approval is issued by the Owner.
- B. See Section 01 60 00, Paragraph 1-06 for additional requirements and Contractor responsibility relating to substitutions. Specifically subparagraphs relating to speculative substitutions and additional liabilities.

16.4 Codes, Rules and Regulations

- A. All Work is to be in accord with the latest requirements of:
 - 1. Federal, State and Municipal Laws;
 - 2. Rhode Island Building and Fire Codes; and
 - 3. Any prevailing rules and regulations pertaining to the adequate protection and/or guarding of any moving parts or other hazardous locations.
- B. Reference in Specifications or Drawings shall mean and intend the latest edition of such, as published at date of submission of bids.
- C. Reference to technical society organizations or body is made per the following abbreviations:

AIA	American Institute of Architects
AISE	American Institute of Electrical Engineers
AISC	American Institute of Steel Construction
ASA	American Standards Association
ASME	American Society of Mechanical Engineers
ASTM	American Society of Testing and Materials
AWSC	American Welding Society
CS	Commercial Standard of U.S. Dept. of Commerce
FS	Federal Specifications
NBS	National Bureau of Standards
NEC	National Electric Code
UBC	Uniform Building Code
UL	Underwriters' Laboratories, Inc.
AASHO	American Assoc. of State Highway Officials

- D. All Contractors and Subcontractors shall comply with requirements of the Occupational Safety and Health Act of 1970 or revisions thereto, which are applicable during the term of this Contract and hold the Owner and/or his agents harmless from any claim or loss that may result from violations of or claims under this act.
- E. Nothing in the Specifications or Drawings is to be construed to allow Work not in accord with the above requirements. When requirements shown or specified are less than those in the codes listed above, the Contractor is to furnish and/or install the larger size or higher standard without extra cost to the Owner.
- F. All Contractors and material/equipment suppliers shall comply with the Lead Based Paint Poisoning Prevention Act (42 U.S.C. 4821-4826) and H.U.D. implementing regulations and the Rhode Island General Laws.

16.5 Drawings

- A. Structural drawings need not show architectural finishes. Architectural drawings need not show completed structural and/or mechanical or electrical installation or vice versa.
- B. Architectural drawings shall have precedence over all other drawings.
- C. All Work drawn on plans and not specified, or all Work specified and not drawn are part of Contract Work required to be done and are to be executed as fully as if described in both of these ways. Only Work specifically noted in the following manner shall be considered as not being in the contract:
 - "...by Owner"
 - "...NIC (Not In Contract)"
- D. If, after examination of Contract Drawings and Specifications, or after a visit to the premises, any discrepancies, omissions, ambiguities, or conflicts are found in the Contract Documents or there is doubt as to their meaning, the Architect is to be notified immediately, in writing. Where information sought is not clearly indicated or specified, the Architect will issue addendum to the Contractor clarifying conditions and which addendum will become part of the Contract Documents. Neither the Owner nor the Architect will be responsible for any oral instructions.

- E. If there are two (2) ways and/or instruction in drawings and/or specifications, it shall be assumed that the Contractor has based its Base Bid price on the most expensive way.
- F. If duplication is shown on drawings and/or specifications of Work by more than one (1) trade, Owner shall determine which trade shall do Work and rebate shall be due from the other trades to Owner.
- G. Drawings DO NOT include any necessary components for construction safety.
- H. In all work shown on Drawings, figured dimensions are to be followed in all cases, though they may differ from scaled measurements. Before beginning the work, Contractor is to check through and verify all dimensions/elevations and call to the attention of the Architect any apparent or manifest discrepancy.
 - 1. Contractor shall verify all dimensions with existing and actual field conditions, prior to start of any work.
- I. All work and materials shown on drawings shall be interpreted by the Contractor as being new work and materials to be furnished and installed unless they are specifically indicated as being existing and to remain.

16.6 Manufacturer's Directions

- A. Manufactured articles, materials and equipment must be applied, installed, connected, erected, used, cleaned, and / or conditioned in accordance with manufacturer's printed directions unless specified to the contrary.
- B. If there is a conflict between the Contract Documents and manufacturer's directions, the Contractor shall notify the Architect in writing. Contractor shall not proceed with Work until Architect has reviewed the conflicting data and provided the Contractor with a decision on which specification to follow.

16.7 Dimensions

- A. In all Work shown on Drawings, figured dimensions are to be followed in all cases, though they may differ from scaled measurements before beginning the Work, Contractor is to check through all dimensions and call to the attention of the Owner for adjustment any apparent or manifest discrepancy. Contractor shall verify all dimensions with existing and actual field conditions prior to start of construction and assumes all responsibility regarding the same.

16.8 Foreign Corporations

- A. The attention of the General Contractor is hereby directed to excerpts from Chapters 1 - 6 of Title 7 of the General Laws of Rhode Island, 1956, relative to the conditions precedent, etc. to carrying on business within the State for foreign corporations.
- B. The certificate and power of attorney mentioned in the General Corporations Law, properly filled out, subscribed and sworn to and accompanied by a certified copy of the charter, articles of association, or other similar organization papers, together with all amendments, must be filed in the Office of the Secretary of State by all foreign corporations intending to carry on business within this State, or for a foreign corporation to enforce in the courts of this State any contract made within the State.
- C. Detailed information regarding Chapters 1 - 6 of Title 7 of the General Laws of Rhode Island, 1956, relative to the conditions precedent, etc., to carrying on business with this State for Foreign Corporations may be obtained from the Rhode Island Secretary of State, State House, Smith Street, Providence, Rhode Island or by going to www.state.ri.us.

16.9 Contractor's Agreement

- A. During the performance of this contract, the Contractor agrees to comply with all provisions of Executive Order 11246, as amended, relative to the Equal Employment Opportunity for all persons without regard to race, color, religion, sex or national origin, and the implementing rules and regulations prescribed by the Secretary of Labor.
- B. In the event of the Contractor's non-compliance with the non-discrimination clauses of this contract or with any such rules, regulations or orders, this contract may be cancelled, terminated or suspended in whole or in part and the Contractor may be declared ineligible for further contracts.

16.10 General Specification Note

- A. The paragraph entitled "WORK INCLUDED" in each section of the technical specifications shall be considered general in nature and NOT all inclusive. The intent of the paragraph is to provide a general guide of what is included in the section.
- B. The paragraph entitled "RELATED WORK" in each section of the technical section shall be considered general in nature and NOT all inclusive. The intent of the paragraph is to provide a general guide of what Work is related to Work included in this section.

16.11 Signs

- A. Contractors, subcontractors and sub-contractors are prohibited from displaying signs of any kind at the site, including advertisements, except as approved by the Owner or as required by authorities having jurisdiction.

16.12 Drawings and Specifications

- A. Contract Drawings and Specifications, one (1) CD will be furnished to the Contractor without cost. Printing of hard copies for contractor's use shall be the responsibility of the contractor. Printing of hard copies for permits and approvals shall be by owner.

16.13 Work Not Specified

- A. Work shown on drawings concerning which there are no particular specification shall not relieve Contractor from furnishing and installing same. Contractors shall review plans carefully for miscellaneous Work not specified and shall perform such Work with materials and Workmanship of the highest quality.

16.14 Meaning and Intent

- A. The Contractor shall provide items such as attachments, hangers, bolts and screws, which are obviously needed to perform Work properly but are not specifically indicated on the drawings and specifications.
- B. INTENT: It is the intent of the plans and these specifications that all design, equipment, materials and Workmanship used on this Project be in complete conformance with all local, state and national codes, ordinances and standards. It is the Contractor's responsibility to submit only those items that meet these codes. Should an item be inadvertently specified by model number that is not in conformance with local and state codes, the Contractor shall notify the proper authorities prior to any submittals of the item. Regardless of any approval action given, it is the Contractor's responsibility to install only those items that are in conformance with applicable codes. Should any non-conforming code items be installed, they shall be replaced by the Contractor at no additional cost to the Owner.

16.15 Use of the Premises

- A. Since the premises are occupied, Work is to be done as expeditiously as possible and with as little inconvenience as possible and without danger to occupants. The Contractors, subs, etc. shall conduct Work in such manner as to allow continued operation with minimum of interference, use and function of the buildings and premises and schedule Work in consultation with Owner or his representative. The Contractor shall leave unobstructed ways along roadways and walks, except as approved by Owner in writing and restrict introduction of materials and access and egress of Workmen and vehicles to such places as approved by Owner. The Contractor shall notify the Owner no later than twenty four (24) hours prior to any interference, obstruction and restriction on the Owner's use of the premises and await Owner's written approval prior to such interference. All floors, wall surfaces and ceilings shall be protected during construction.

16.16 Existing Utilities and Structures

- A. All existing utilities are NOT indicated on the drawings. Contractors shall use caution during construction and assume all responsibility for damage to utilities except as otherwise expressly provided herein. The Owner will cooperate fully, at the Contractor's written request, in assisting the contractor in locating and identifying underground utilities.
- B. The Contractor shall take all precautions to prevent any damage to utilities and structures encountered during the Work and ensure that they remain in constant operation except as may be required to connect or disconnect from them and shall immediately repair any active existing utility lines (cables, conduits, ducts, and piping) damaged during the performance of the Work except where such lines are to be abandoned. The Contractor shall be responsible for any and all damages to utility piping, drains, sewers, electrical wiring and conduits, buildings and/or other structures that may be met within the performance of the Work including damages

caused by Subcontractors, Sub-subcontractors and material manufacturers, their agents or employees. The Contractor shall protect and maintain such active existing utilities in use, until relocation of same has been complete or cut, or capped, or prepared for service connections, as applicable; and perform such repair and protection Work at no additional cost to the Owner. The Contractor shall put in place shores, slings and/or other devices necessary to prevent such damage.

- C. The Contractor shall notify the Owner in writing not less than three (3) days in advance of the proposed time for shutting down or interrupting any utilities, services or facilities which may affect the operation of other buildings, services or facilities of the Owner. Unless otherwise authorized by the Owner, the Contractor shall schedule and coordinate this Work such that interruption will occur on weekends, holidays or before or after normal Working hours of the Owner's facility. In no case shall any shutdown or interruption of any utilities, services or facilities be made without the prior written approval and the authorization of the Owner.

16.17 Protection of Persons and Property

- A. The Contractor shall provide and maintain, for the duration of the Contract, proper protective measures as may be required to adequately protect the Owner's personnel and the public from hazards resulting from the Work performed hereunder.
- B. The Contractor shall take all proper precautions to protect the Owner's property from damages and replace, or put in good condition, any existing items which are damaged in carrying out the Work, unless designated to be permanently removed or demolished.
- C. When regulated by local building code or other Authority, such requirements for protection shall be considered as minimum requirements and the Contractor shall be responsible for the protection of such minimum requirements as may be required by public safety laws.
- D. The requirements of this paragraph shall be in addition to, not in lieu of, other protection requirements contained in the Contract Documents.

16.18 Damage from the Elements

- A. The Contractor will be held responsible for all damage to new and existing construction and damage and/or loss to any and all materials and/or equipment located at the site from the elements until acceptance by the Owner.
- B. The intent of this paragraph is to protect the Owner against claims made for reimbursement in cases where materials are improperly stored, protected or erected in such a manner that rain, snow, sunlight or other normal damage to these materials from the elements would result. Unforeseen natural disasters, etc., are presumed to be covered by the usual forms of property damage insurance maintained by the Contractor.

16.19 Safety and Health

- A. The Contractor shall provide protective devices required by authorities having jurisdiction. The contractor shall take, use, provide and make all proper, necessary and sufficient precautions, safeguards and protection against occurrence of any accident, injury to any person or object during progress of Work. The contractor

shall provide and erect temporary fences, guards, etc., required to protect Owner's employees, the public and/or Workmen, and remove same when the Work is completed. The contractor shall keep all passageways clear and safe, and comply with provisions of the following Federal Laws and regulations, as amended:

1. Occupational Safety & Health Act of 1970, Public Law 91-596.
2. Part 1510-Occupational Safety and Health Standards, Chapter XVII of Title 29, Code of Federal Regulations.
3. Chapter XIII of Title 29, Code of Federal Regulations, Part 1518-Safety and Health Regulations of Construction. (36 FR 75)
4. Any and all other applicable state or federal laws, codes, and/or regulations.

16.20 Indemnification

- A. To the fullest extent permitted by law and notwithstanding any approvals or instructions which may be obtained from Owner in connection with use of premises, the Contractor agrees to indemnify and save the Owner and Architect harmless from and (1) against any and all claims, loss, liability, injury including death, damage or costs by any person, firm, corporation or other entity including without limitation those claiming by, through or under the Contractor, its officers, agents, servants, employees, parents, subsidiaries, partners, officers, directors, attorneys, insurers, and/or affiliates, in any capacity whatsoever, including all subrogation claims and/or all claims for reimbursement, including court costs and attorneys fees and/or any other costs of defending an action arising out of or resulting from the Work provided for or performed under the Contract Documents or from any act, omission, or negligence of the Contractor, Subcontractors and their agents, or employees; and (2) any and all legal actions including third-party actions, cross-actions, and/or claims for contribution and/or indemnity with respect to any claims by any other persons, entities, parties, which may arise out of or result from the Work provided for or performed under the Contract Documents. The foregoing provisions shall not be deemed to be released, waived or modified in any respect by reason of any surety or insurance provided by the Contractor under the Contract.
- B. To the fullest extent permitted by law, the Contractor, subcontractors, sub-subcontractors, their officers, agents, servants, employees, parents, subsidiaries, partners, officers, directors, attorneys, insurers, and/or affiliates, release, waive, discharge and covenant not to sue the Owner, its officers, agents, servants and/or employees for any and all liability, claims, cross-claims, rights in law or in equity, agreements, demands, actions and any causes of actions whatsoever arising out of or related to any loss, damages, expenses (including without limitation any court costs and attorneys fees, interest and penalties) or injury of any type, kind or nature whatsoever (including death), whether based in contract, tort, warranty, or other legal, statutory, or equitable theory of recovery, which relates to or arises out of the Work provided for or performed under the Contract Documents.
- C. The Contractor shall reimburse the Owner for any and all damage to its real or personal property caused by the acts of the Contractor, Subcontractors, Sub-subcontractors, their agents or employees.
- D. The duties of Contractor, Subcontractors, etc. under this section shall remain fully in effect and binding in accordance with the terms and conditions of the Contract, without being lessened or compromised in any way, even when the Contractor is alleged or is found to merely have contributed in part to the acts giving rise to the claims and/or where the Owner is alleged or is found to have contributed to the acts giving rise to the claims.

- E. Asbestos Material Identification and Removal: During demolition operations, it shall be the responsibility of the Contractor to identify any asbestos materials that may be encountered. Should they be encountered, the Contractor shall immediately notify the Owner, stop Work in the area of concern, and not proceed with any work in that area until further notice. It is understood and agreed that the handling or removal of asbestos or asbestos products involves certain health risks which require specific safety measures. The Architect and Owner shall not be responsible for safety and safety measures on the job, including measures for the protection of employees of Contractor, Subcontractors, Sub-subcontractors, their employees and agents, nor for the protection of the general public. Such responsibility for safety and safety measures is and shall remain that of the Contractor. The Contractor, Subcontractors, Sub-subcontractors, their employees and agents, shall hold harmless and indemnify the Architect and Owner from all claims, suits, expenses and/or damages arising from or alleged to arise from exposure to or inhalation of asbestos or asbestos fibers.

16.21 Reports and Information

- A. Performance of the Work under this contract will be monitored. The Contractor, Subcontractors, Sub-subcontractors, their employees and agents shall provide information, as may be requested, in form as required by the Owner or Architect, pertaining to matters covered by this contract.

16.22 Clean Air and Water

- A. The Contractor shall comply with requirements of Section 114 of the Clean Air Act, as amended, 42 USC § 1857 *et seq.* and Section 308 of Clean Water Act, as amended, 33 USC § 1318 and regulations and guidelines issued thereunder. The Contractor shall not use any facility listed on List of Violating Facilities issued by Environmental Protection Agency (EPA) pursuant to 40 CFR § 15.20.

16.23 Records

- A. The Contractor shall maintain records with respect to matters covered by this Contract for a period of three (3) years after receipt of final payment including, but not limited to, costs, supported by checks, properly executed payrolls, time records, invoices, contracts, vouchers, accounting and other documents evidencing nature and propriety of charges or conditions of employment or purchasing, and shall maintain the records in a manner that they are readily accessible, clearly identified and available for audit by the Owner.

16.24 Overhead and Profit

- A. The maximum allowance for overhead and profit combined, included in the total cost to the PHA, shall be based upon the following schedule:
1. For the Contractor, for any work performed by his own forces, maximum of 10% of the cost;
 2. For the Subcontractor involved, for any work performed by his own forces, maximum of 10% of the cost;
 3. For the Contractor or Subcontractor, for work performed by their Subcontractor, maximum 5% of the cost, not including overhead and profit, due the Subcontractor or Sub-subcontractor.

END OF SECTION 00 73 00

SECTION 00 73 46 – WAGE DETERMINATION SCHEDULE

The State of Rhode Island Department of Labor, Division of Professional Regulation General Decision Modification document current as of the RFP issuance date for this Project, is an integral part of the Bid Documents for use in fulfilling prevailing wage rate requirements. A copy is available on the web site of the State of Rhode Island Department of Administration, Division of Purchases.

The Division of Purchases Web Site Address:

www.purchasing.ri.gov

Click on “General Information”; then click on “Prevailing Wage Tables”.

END OF SECTION 00 73 46

SECTION 01 10 00 – SUMMARY**PART 1 - GENERAL****1.1 RELATED DOCUMENTS**

- A. Drawings and general provisions of the Contract, including General and Supplementary Conditions and other Division 01 Specification Sections, apply to this Section.

1.2 SUMMARY

- A. Section Includes:
 - 1. Project information.
 - 2. Work covered by Contract Documents.
 - 3. Phased construction.
 - 4. Work by Owner.
 - 5. Work under separate contracts.
 - 6. Owner-furnished products.
 - 7. Access to site.
 - 8. Work restrictions.
 - 9. Specification and drawing conventions.
 - 10. Miscellaneous provisions.

1.3 PROJECT INFORMATION

- A. Project Identification: Fire Alarm Upgrades, McGrath Judicial Complex, Wakefield, Rhode Island.
 - 1. Project Location: 4800 Tower Hill Road, Wakefield, Rhode Island 02879.
- B. Owner: Rhode Island Judiciary, 250 Benefit Street, Providence Rhode Island 02903.

Owner's Representative: Steven J. Kerr, Asst. State Court Administrator for Facilities, Operations and Security, RI Supreme Court
- C. Architect: Edward Rowse Architects, Inc., 400 Massasoit Avenue, Suite 300, 2nd Floor, East Providence, Rhode Island 02914

1.4 DEFINITIONS

- A. General: Basic Contract definitions are included in the Conditions of the Contract.
- B. "Approved": When used to convey Architect's action on Contractor's submittals, applications, and requests, "approved" is limited to Architect's duties and responsibilities as stated in the Conditions of the Contract.
- C. "Directed": A command or instruction by Architect. Other terms including "requested," "authorized," "selected," "required," and "permitted" have the same meaning as "directed."

- D. "Indicated": Requirements expressed by graphic representations or in written form on Drawings, in Specifications, and in other Contract Documents. Other terms including "shown," "noted," "scheduled," and "specified" have the same meaning as "indicated."
- E. "Regulations": Laws, ordinances, statutes, and lawful orders issued by authorities having jurisdiction, and rules, conventions, and agreements within the construction industry that control performance of the Work.
- F. "Furnish": Supply and deliver to Project site, ready for unloading, unpacking, assembly, installation, and similar operations.
- G. "Install": Operations at Project site including unloading, temporarily storing, unpacking, assembling, erecting, placing, anchoring, applying, working to dimension, finishing, curing, protecting, cleaning, and similar operations.
- H. "Provide": Furnish and install, complete and ready for the intended use.

1.5 WORK COVERED BY CONTRACT DOCUMENTS

- A. Work of this Contract is comprised of replacing the existing conventional fire alarm system with a new addressable fire alarm system. The new addressable fire alarm system shall be operational prior to the removal of the existing conventional fire alarm system.
- B. Type of Contract:
 - 1. Project will be constructed under a single prime contract.

1.6 WORK BY OWNER

- A. General: Cooperate fully with Owner so work may be carried out smoothly, without interfering with or delaying work under this Contract or work by Owner. Coordinate the Work of this Contract with work performed by Owner.

1.7 ACCESS TO SITE

- A. General: Contractor shall be restricted to areas outlined under the contract. The Courts shall remain in full function during the time of construction. Contractor's use of Project site is limited by Owner's right to perform work or to retain other contractors on portions of Project.
 - 1. Driveways, Walkways and Entrances: Contractor access to the building shall be the main building entrance. Keep driveways, parking areas, loading areas and entrances serving premises clear and available to Owner, Owner's employees, public and emergency vehicles at all times.
 - a. Coordinate closure, use and construction in this area with the Owner. The Owner requires a minimum of 7 days notification of Contractor's intent to close off this roadway.
 - b. Contractor shall indicate on construction schedule proposed closure, use and construction dates / times in this area.
 - c. Schedule closures, construction, deliveries, etc. to minimize use of roadway and entrance by construction operations.

- d. Schedule deliveries to minimize space and time requirements for delivery of materials and equipment on-site.

1.8 WORK RESTRICTIONS

- A. Work Restrictions, General: Comply with restrictions on construction operations.
 1. Comply with limitations on use of public streets and with other requirements of authorities having jurisdiction.
- B. On-Site Work Hours: Limit work to working hours of 5:00 p.m. to 12:00 a.m., Monday through Friday, unless otherwise indicated.
 1. Weekend and Overtime Hours: Shall be as approved by the Owner and Architect. This is not to limit the hours the contractor can perform work, but to only allow the Owner and Architect to have personnel available (in person or by phone) for questions or other issues.
 2. Early Morning or Evening Hours: Shall be as regulated by authorities having jurisdiction for restrictions on noisy work.
- C. Parking:
 1. There is on-site parking available in the main parking lot in front of the building.
- D. Existing Utility Interruptions: Do not interrupt utilities serving facilities occupied by Owner or others unless permitted under the following conditions and then only after providing temporary utility services according to requirements indicated:
 1. Notify Owner not less than four days in advance of proposed utility interruptions.
 2. Obtain Owner's written permission before proceeding with utility interruptions.
- E. Noise, Vibration, and Odors: Coordinate operations that may result in high levels of noise and vibration, odors, or other disruption to Owner or others.
 1. Notify Owner not less than four days in advance of proposed disruptive operations.
 2. Obtain Owner's written permission before proceeding with disruptive operations.
- F. Nonsmoking Building: Smoking is not permitted within the building or within 25 feet (8 m) of entrances, operable windows, or outdoor-air intakes.
- G. Controlled Substances: Use of tobacco or controlled substances on Project site is not permitted.

1.9 SPECIFICATION AND DRAWING CONVENTIONS

- A. Specification Content: The Specifications use certain conventions for the style of language and the intended meaning of certain terms, words, and phrases when used in particular situations. These conventions are as follows:
 1. Imperative mood and streamlined language are generally used in the Specifications. The words "shall," "shall be," or "shall comply with," depending on the context, are implied where a colon (:) is used within a sentence or phrase.
 2. Specification requirements are to be performed by Contractor unless specifically stated otherwise.

- B. Division 01 General Requirements: Requirements of Sections in Division 01 apply to the Work of all Sections in the Specifications.
- C. Drawing Coordination: Requirements for materials and products identified on Drawings are described in detail in the Specifications. One or more of the following are used on Drawings to identify materials and products:
 - 1. Terminology: Materials and products are identified by the typical generic terms used in the individual Specifications Sections.
 - 2. Abbreviations: Materials and products are identified by abbreviations published as part of the U.S. National CAD Standard and scheduled on Drawings.
 - 3. Keynoting: Materials and products are identified by reference keynotes referencing Specification Section numbers found in this Project Manual.

1.10 CODES, RULES AND REGULATIONS

- A. All work is to be in accordance with the latest requirements of:
 - 1. Federal, State and Municipal Laws
 - 2. Rhode Island Building and Fire Codes
 - 3. National Plumbing Code
 - 4. National Electric Code
 - 5. Any prevailing rules, regulations pertaining to adequate protection and/or guarding of any moving parts or otherwise hazardous locations.

1.11 INDUSTRY STANDARDS

- A. Applicability of Standards: Unless the Contract Documents include more stringent requirements, applicable construction industry standards have the same force and effect as if bound or copied directly into the Contract Documents to the extent referenced. Such standards are made a part of the Contract Documents by reference.
- B. Publication Dates: Comply with standards in effect as of date of the Contract Documents unless otherwise indicated.
- C. Copies of Standards: Each entity engaged in construction on Project should be familiar with industry standards applicable to its construction activity. Copies of applicable standards are not bound with the Contract Documents.
 - 1. Where copies of standards are needed to perform a required construction activity, obtain copies directly from publication source.

1.12 JOB SAFETY AND ACCIDENT PREVENTION

- A. All construction work on this project must be performed in compliance with the Occupational Safety and Health Act of 1970 or with local or State occupational safety and health regulations enforced by an agency of the locality or State under a plan approved by the U.S. Department of Labor Occupational Safety and Health Administration (OSHA)
- B. All contractors and subcontractors shall comply with requirements of the Occupational Safety and Health Act of 1970 or revisions thereto, which are applicable during the

term of this contract and hold the Owner and Architect and/or their agents harmless from any claim or loss that may result from violations of or claims under this act.

- C. See the General Conditions for further requirements.

1.13 SCHEDULE OF VALUES

- A. Coordination: Coordinate preparation of the schedule of values with preparation of Contractor's construction schedule.
1. Coordinate line items in the schedule of values with other required administrative forms and schedules, including the following:
 - a. Application for Payment forms with continuation sheets.
 - b. Submittal schedule.
 - c. Items required to be indicated as separate activities in Contractor's construction schedule.
 2. Submit the schedule of values to Architect at earliest possible date but no later than 15 days from date of notice to proceed.
 3. Sub-schedules for Phased Work: Where the Work is separated into phases requiring separately phased payments; provide sub-schedules showing values coordinated with each phase of payment.
- B. Format and Content: Use Project Manual table of contents as a guide to establish line items for the schedule of values. Provide at least one line item for each Specification Section.
1. Identification: Include the following Project identification on the schedule of values:
 - a. Project name and location.
 - b. Name of Architect.
 - c. Architect's project number.
 - d. Contractor's name and address.
 - e. Date of submittal.
 2. Provide a breakdown of the Contract Sum in enough detail to facilitate continued evaluation of Applications for Payment and progress reports. Coordinate with Project Manual table of contents. Provide multiple line items for principal subcontract amounts in excess of five percent of the Contract Sum.
 - a. Include separate line items labor and materials.
 3. Round amounts to nearest whole dollar; total shall equal the Contract Sum.
 4. Provide a separate line item in the schedule of values for each part of the Work where Applications for Payment may include materials or equipment purchased or fabricated and stored, but not yet installed.
 5. Provide separate line items in the schedule of values for initial cost of materials, for each subsequent stage of completion, and for total installed value of that part of the Work.
 6. Allowances: Provide a separate line item in the schedule of values for each allowance. Show line-item value of unit-cost allowances, as a product of the unit cost, multiplied by measured quantity. Use information indicated in the Contract Documents to determine quantities.

7. Each item in the schedule of values and Applications for Payment shall be complete. Include total cost and proportionate share of general overhead and profit for each item.
 - a. Temporary facilities and other major cost items that are not direct cost of actual work-in-place may be shown either as separate line items in the schedule of values or distributed as general overhead expense, at Contractor's option.
8. Schedule Updating: Update and resubmit the schedule of values before the next Applications for Payment when Change Orders or Construction Change Directives result in a change in the Contract Sum.

1.14 MISCELLANEOUS PROVISIONS

A. SUPERINTENDENCE OF SUBCONTRACTORS

1. The contractor must supervise subcontractors in accordance with the provisions of General Conditions. A project superintendent shall be on site whenever any work is being performed. Superintendent shall be an employee of the Contractor.
2. Project superintendent shall be acceptable to the Owner and Architect. Submit superintendent's qualifications for review and acceptance within two days of the notice of award or notice to proceed whichever is first.

B. COORDINATION

1. Prior to commencement of subcontract work, a designated representative of each subcontractor shall meet with project superintendent, Owner and Architect at the site to discuss requirements and scope of Work.
2. The Contractor and all subcontractors will be required to attend a preconstruction conference at a date and time set by the Owner.

C. BEHAVIOR OF PERSONNEL

1. If in the opinion of the Owner or Architect, any employee of the Contractor or his subcontractors is physically or mentally unfit for work or exhibits behavior incompatible with work site environment, said employee may be required to leave property and may be refused re-admittance.

D. SUBSTITUTIONS

1. In all cases where a proprietary designation is used in connection with materials or articles to be furnished under this contract and the phrase "or equal" is not used, the Contractor shall furnish the specified item, unless a written request for a substitute has been submitted by the Contractor and review by the Architect to his satisfaction.
2. See Section 01 60 00 for additional requirements and Contractor responsibility relating to substitutions. Specifically, subparagraphs relating to speculative substitutions and additional liabilities.

E. DRAWINGS AND SPECIFICATIONS

1. All work drawn on Plans and not specified or all work specified and not drawn are part of Contract Work required to be done and are to be executed as fully as if described in both of these ways. Only work specifically noted in the following manner shall be considered as not being in the contract:
2. ".....by Owner".

3. ".....NIC (Not In Contract)".
4. If, after examination of Contract Drawings and Specifications, or after a visit to the premises, any discrepancies, omissions, ambiguities, or conflicts are found in or amount contract documents or there is doubt as to their meaning, Architect is to be notified at the earliest possible date. Where information sought is not clearly indicated or specified, the Architect will issue addendum to the Contractor clarifying conditions, which addendum will become part of the Contract Documents. Neither the Owner nor the Architect will be responsible for any oral instructions.
5. If there are two ways and/or instruction in drawings and/or specifications, it shall be assumed that the Contractor has based his base bid price on the most expensive way.
6. If duplication is shown on drawings and/or specifications of work by more than one trade, Architect shall determine which trade shall do work and rebate shall be due from the other trades to Owner.
7. Drawings DO NOT include any necessary components for construction safety.
8. In all work shown on Drawings, figured dimensions are to be followed in all cases, though they may differ from scaled measurements. Before beginning the work, Contractor is to check through and verify all dimensions/elevations and call to the attention of the Architect any apparent or manifest discrepancy.
9. Contractor shall verify all dimensions with existing and actual field conditions, prior to start of any work.
10. All work and materials shown on drawings shall be interpreted by the Contractor as being new work and materials to be furnished and installed unless are specifically indicated as existing to remain.

PART 2 - PRODUCTS (Not Used)

PART 3 - EXECUTION (Not Used)

END OF SECTION 01 10 00

SECTION 01 21 00 - ALLOWANCES**PART 1 - GENERAL****1.1 RELATED DOCUMENTS**

- A. Drawings and general provisions of the Contract, including General and Supplementary Conditions and other Division 01 Specification Sections, apply to this Section.

1.2 SUMMARY

- A. Section includes administrative and procedural requirements governing allowances.
 - 1. Certain items are specified in the Contract Documents by allowances. Allowances have been established in lieu of additional requirements and to defer selection of actual materials and equipment to a later date when direction will be provided to Contractor. If necessary, additional requirements will be issued by Change Order.
- B. Types of allowances include the following:
 - 1. Lump-sum allowances.
 - 2. Contingency allowances.
- C. Related Requirements:
 - 1. Division 01 Section "Unit Prices" for procedures for using unit prices.
 - 2. Divisions 02 through 26 Sections for items of Work covered by allowances.

1.3 SELECTION AND PURCHASE

- A. At the earliest practical date after award of the Contract, advise Architect of the date when final selection and purchase of each product or system described by an allowance must be completed to avoid delaying the Work.
- B. At Architect's request, obtain proposals for each allowance for use in making final selections. Include recommendations that are relevant to performing the Work.
 - 1. If proposals are requested by the Architect the contractor shall provide a minimum of 3 proposals for each product or system.
- C. Purchase products and systems selected by Architect from the designated supplier.

1.4 ACTION SUBMITTALS

- A. Submit proposals for purchase of products or systems included in allowances, in the form specified for Change Orders.

1.5 INFORMATIONAL SUBMITTALS

- A. Submit invoices or delivery slips to show actual quantities of materials delivered to the site for use in fulfillment of each allowance.
- B. Submit time sheets and other documentation to show labor time and cost for installation of allowance items that include installation as part of the allowance.
- C. Coordinate and process submittals for allowance items in same manner as for other portions of the Work.

1.6 COORDINATION

- A. Coordinate allowance items with other portions of the Work. Furnish templates as required to coordinate installation.

1.7 ALLOWANCES

- A. Allowance shall include cost to Contractor of specific products and materials ordered by Owner or selected by Architect under allowance and shall include taxes, freight, and delivery to Project site.
- B. Unless otherwise indicated, Contractor's costs for receiving and handling at Project site, labor, installation, overhead and profit, and similar costs related to products and materials selected by Architect under allowance shall be included as part of the Contract Sum and not part of the allowance.

1.8 CONTINGENCY ALLOWANCES

- A. Use the contingency allowance only as directed by Architect for Owner's purposes and only by Change Orders that indicate amounts to be charged to the allowance.
- B. Contractor's overhead, profit, and related costs for products and equipment ordered by Owner under the contingency allowance are included in the allowance and are not part of the Contract Sum. These costs include delivery, installation, insurance, equipment rental, and similar costs.
- C. Change Orders authorizing use of funds from the contingency allowance will include Contractor's related costs and reasonable overhead and profit margins.
- D. At Project closeout, credit unused amounts remaining in the contingency allowance to Owner by Change Order.

1.9 ADJUSTMENT OF ALLOWANCES

- A. Allowance Adjustment: To adjust allowance amounts, prepare a Change Order proposal based on the difference between purchase amount and the allowance, multiplied by final measurement of work-in-place where applicable. If applicable, include reasonable allowances for cutting losses, tolerances, mixing wastes, normal product imperfections, and similar margins.
 - 1. Include installation costs in purchase amount only where indicated as part of the allowance.

2. If requested, prepare explanation and documentation to substantiate distribution of overhead costs and other margins claimed.
3. Submit substantiation of a change in scope of work, if any, claimed in Change Orders related to unit-cost allowances.
4. Owner reserves the right to establish the quantity of work-in-place by independent quantity survey, measure, or count.

PART 2 - PRODUCTS (Not Used)

PART 3 - EXECUTION

3.1 EXAMINATION

- A. Examine products covered by an allowance promptly on delivery for damage or defects. Return damaged or defective products to manufacturer for replacement.

3.2 PREPARATION

- A. Coordinate materials and their installation for each allowance with related materials and installations to ensure that each allowance item is completely integrated and interfaced with related work.

3.3 SCHEDULE OF ALLOWANCES

- A. Allowance No. 1: Contingency Allowance: Include a contingency allowance of \$10,000.00 for use according to Owner's written instructions.
 1. This allowance includes material cost, receiving, handling, and installation, and Contractor overhead and profit.

END OF SECTION 01 21 00

SECTION 01 31 00 - PROJECT MANAGEMENT AND COORDINATION**PART 1 - GENERAL****1.1 RELATED DOCUMENTS**

- A. Drawings and general provisions of the Contract, including General and Supplementary Conditions and other Division 01 Specification Sections, apply to this Section.

1.2 SUMMARY

- A. Section includes administrative provisions for coordinating construction operations on Project including, but not limited to, the following:
 - 1. General coordination procedures.
 - 2. Requests for Information (RFIs).
 - 3. Project meetings.
- B. Each contractor shall participate in coordination requirements. Certain areas of responsibility are assigned to a specific contractor.
- C. Related Requirements:
 - 1. Division 01 Section "Construction Progress Documentation" for preparing and submitting Contractor's construction schedule.
 - 2. Division 01 Section "Closeout Procedures" for coordinating closeout of the Contract.
 - 3. Division 01 Section "Execution" for procedures for coordinating general installation and field-engineering services, including establishment of benchmarks and control points.

1.3 DEFINITIONS

- A. RFI: Request from Owner, Architect, or Contractor seeking information required by or clarifications of the Contract Documents.

1.4 INFORMATIONAL SUBMITTALS

- A. Subcontract List: Prepare a written summary identifying individuals or firms proposed for each portion of the Work, including those who are to furnish products or equipment fabricated to a special design. Include the following information in tabular form:
 - 1. Name, address, and telephone number of entity performing subcontract or supplying products.
 - 2. Number and title of related Specification Section(s) covered by subcontract.
 - 3. Drawing number and detail references, as appropriate, covered by subcontract.
- B. Key Personnel Names: Within 15 days of starting construction operations, submit a list of key personnel assignments, including superintendent and other personnel in attendance at Project site. Identify individuals and their duties and responsibilities; list addresses and telephone numbers, including home, office, and cellular telephone numbers and e-mail

addresses. Provide names, addresses, and telephone numbers of individuals assigned as alternates in the absence of individuals assigned to Project.

1.5 GENERAL COORDINATION PROCEDURES

- A. Coordination: Coordinate construction operations included in different Sections of the Specifications to ensure efficient and orderly installation of each part of the Work. Coordinate construction operations, included in different Sections, which depend on each other for proper installation, connection, and operation.
1. Schedule construction operations in sequence required to obtain the best results where installation of one part of the Work depends on installation of other components, before or after its own installation.
 2. Coordinate installation of different components to ensure maximum performance and accessibility for required maintenance, service, and repair.
 3. Make adequate provisions to accommodate items scheduled for later installation.
- B. Prepare memoranda for distribution to each party involved, outlining special procedures required for coordination. Include such items as required notices, reports, and list of attendees at meetings.
1. Prepare similar memoranda for Owner and separate contractors if coordination of their Work is required.
- C. Conservation: Coordinate construction activities to ensure that operations are carried out with consideration given to conservation of energy, water, and materials. Coordinate use of temporary utilities to minimize waste.
1. Salvage materials and equipment involved in performance of, but not actually incorporated into, the Work. See other Sections for disposition of salvaged materials that are designated as Owner's property.

1.6 REQUESTS FOR INFORMATION (RFIs)

- A. General: Immediately on discovery of the need for additional information or interpretation of the Contract Documents, Contractor shall prepare and submit an RFI in the form specified.
1. Architect will return RFIs submitted to Architect by other entities controlled by Contractor with no response.
 2. Coordinate and submit RFIs in a prompt manner so as to avoid delays in Contractor's work or work of subcontractors.
- B. Frivolous RFIs: RFIs generated by the contractor because of his failure to adequately study and compare the Contract Documents, or coordinating their own work, shall be considered frivolous. The contractor shall pay all A/E and owner costs associated with responding to these RFIs.
- C. Content of the RFI: Include a detailed, legible description of item needing information or interpretation and the following:
1. Project name.
 2. Project number.
 3. Date.
 4. Name of Contractor.

5. Name of Architect
 6. RFI number, numbered sequentially.
 7. RFI subject.
 8. Specification Section number and title and related paragraphs, as appropriate.
 9. Drawing number and detail references, as appropriate.
 10. Field dimensions and conditions, as appropriate.
 11. Contractor's suggested resolution. If Contractor's suggested resolution impacts the Contract Time or the Contract Sum, Contractor shall state impact in the RFI.
 12. Contractor's signature.
 13. Attachments: Include sketches, descriptions, measurements, photos, Product Data, Shop Drawings, coordination drawings, and other information necessary to fully describe items needing interpretation.
 - a. Include dimensions, thicknesses, structural grid references, and details of affected materials, assemblies, and attachments on attached sketches.
- D. RFI Forms: AIA Document G716 or another form that in the sole opinion of the Architect is acceptable.
1. Attachments shall be electronic files in Adobe Acrobat PDF format.
- E. Architect's Action: Architect will review each RFI, determine action required, and respond. Allow seven working days plus seven days for consultants for Architect's response for each RFI. RFIs received by Architect after 1:00 p.m. will be considered as received the following working day.
1. The following Contractor-generated RFIs will be returned without action:
 - a. Requests for approval of submittals.
 - b. Requests for approval of substitutions.
 - c. Requests for approval of Contractor's means and methods.
 - d. Requests for coordination information already indicated in the Contract Documents.
 - e. Requests for adjustments in the Contract Time or the Contract Sum.
 - f. Requests for interpretation of Architect's actions on submittals.
 - g. Frivolous, incomplete or inaccurately prepared RFIs.
 2. Architect's action may include a request for additional information, in which case Architect's time for response will date from time of receipt of additional information.
 - a. If Contractor believes the RFI response warrants change in the Contract Time or the Contract Sum, notify Architect in writing within 5 days of receipt of the RFI response.
- F. RFI Log: Prepare, maintain, and submit a tabular log of RFIs organized by the RFI number. Include the following:
1. Project name.
 2. Name and address of Contractor.
 3. Name and address of Architect
 4. RFI number including RFIs that were returned without action or withdrawn.
 5. RFI description.
 6. Date the RFI was submitted.
 7. Date Architect's response was received.

- G. On receipt of Architect's action, update the RFI log and immediately distribute the RFI response to affected parties. Review response and notify Architect within five days if Contractor disagrees with response.
1. Identification of related Minor Change in the Work, Construction Change Directive, and Proposal Request, as appropriate. Identification of related Field Order, Work Change Directive, and Proposal Request, as appropriate.

1.7 PROJECT MEETINGS

- A. General: Schedule and conduct meetings and conferences at Project site unless otherwise indicated.
1. Attendees: Inform participants and others involved, and individuals whose presence is required, of date and time of each meeting. Notify Owner and Architect of scheduled meeting dates and times.
 2. Agenda: Prepare the meeting agenda. Distribute the agenda to all invited attendees.
 3. Minutes: Entity responsible for conducting meeting will record significant discussions and agreements achieved. Distribute the meeting minutes to everyone concerned, including Owner and Architect, within three days of the meeting.
- B. Preconstruction Conference: Schedule and conduct a preconstruction conference before starting construction, at a time convenient to Owner and Architect, but no later than 15 days after execution of the Agreement.
1. Conduct the conference to review responsibilities and personnel assignments.
 2. Attendees: Authorized representatives of Owner, Architect, and their consultants; Contractor and its superintendent; major subcontractors; suppliers; and other concerned parties shall attend the conference. Participants at the conference shall be familiar with Project and authorized to conclude matters relating to the Work.
 3. Agenda: Discuss items of significance that could affect progress, including the following:
 - a. Tentative construction schedule.
 - b. Phasing.
 - c. Critical work sequencing and long-lead items.
 - d. Designation of key personnel and their duties.
 - e. Lines of communications.
 - f. Procedures for processing field decisions and Change Orders.
 - g. Procedures for RFIs.
 - h. Procedures for testing and inspecting.
 - i. Procedures for processing Applications for Payment.
 - j. Distribution of the Contract Documents.
 - k. Submittal procedures.
 - l. Preparation of record documents.
 - m. Use of the premises and existing building.
 - n. Work restrictions.
 - o. Working hours.
 - p. Owner's occupancy requirements.
 - q. Responsibility for temporary facilities and controls.
 - r. Procedures for moisture and mold control.
 - s. Procedures for disruptions and shutdowns.
 - t. Construction waste management and recycling.
 - u. Parking availability.
 - v. Office, work, and storage areas.
 - w. Equipment deliveries and priorities.

- x. First aid.
 - y. Security.
 - z. Progress cleaning.
4. Minutes: Entity responsible for conducting meeting will record and distribute meeting minutes.
- C. Project Closeout Conference: Schedule and conduct a project closeout conference, at a time convenient to Owner and Architect, but no later than 30 days prior to the scheduled date of Substantial Completion.
- 1. Conduct the conference to review requirements and responsibilities related to Project closeout.
 - 2. Attendees: Authorized representatives of Owner, Architect, and their consultants; Contractor and its superintendent; major subcontractors; suppliers; and other concerned parties shall attend the meeting. Participants at the meeting shall be familiar with Project and authorized to conclude matters relating to the Work.
 - 3. Agenda: Discuss items of significance that could affect or delay Project closeout, including the following:
 - a. Preparation of record documents.
 - b. Procedures required prior to inspection for Substantial Completion and for final inspection for acceptance.
 - c. Submittal of written warranties.
 - d. Requirements for preparing operations and maintenance data.
 - e. Requirements for delivery of material samples, attic stock, and spare parts.
 - f. Requirements for demonstration and training.
 - g. Preparation of Contractor's punch list.
 - h. Procedures for processing Applications for Payment at Substantial Completion and for final payment.
 - i. Submittal procedures.
 - j. Responsibility for removing temporary facilities and controls.
 - 4. Minutes: Entity conducting meeting will record and distribute meeting minutes.
- D. Progress Meetings: Conduct progress meetings at weekly intervals.
- 1. Coordinate dates of meetings with preparation of payment requests.
 - 2. Attendees: In addition to representatives of Owner, and Architect, each contractor, subcontractor, supplier, and other entity concerned with current progress or involved in planning, coordination, or performance of future activities shall be represented at these meetings. All participants at the meeting shall be familiar with Project and authorized to conclude matters relating to the Work.
 - 3. Agenda: Review and correct or approve minutes of previous progress meeting. Review other items of significance that could affect progress. Include topics for discussion as appropriate to status of Project.
 - a. Contractor's Construction Schedule: Review progress since the last meeting. Determine whether each activity is on time, ahead of schedule, or behind schedule, in relation to Contractor's construction schedule. Determine how construction behind schedule will be expedited; secure commitments from parties involved to do so. Discuss whether schedule revisions are required to ensure that current and subsequent activities will be completed within the Contract Time.
 - 1) Review schedule for next period.

-
- b. Review present and future needs of each entity present, including the following:
- 1) Interface requirements.
 - 2) Sequence of operations.
 - 3) Status of submittals.
 - 4) Deliveries.
 - 5) Off-site fabrication.
 - 6) Access.
 - 7) Site utilization.
 - 8) Temporary facilities and controls.
 - 9) Progress cleaning.
 - 10) Quality and work standards.
 - 11) Status of correction of deficient items.
 - 12) Field observations.
 - 13) Status of RFIs.
 - 14) Status of proposal requests.
 - 15) Pending changes.
 - 16) Status of Change Orders.
 - 17) Pending claims and disputes.
 - 18) Documentation of information for payment requests.
4. Minutes: Entity responsible for conducting the meeting will record and distribute the meeting minutes to each party present and to parties requiring information.
- 1.8 Schedule Updating: Revise Contractor's construction schedule after each progress meeting where revisions to the schedule have been made or recognized. Issue revised schedule concurrently with the report of each meeting

PART 2 - PRODUCTS (Not Used)

PART 3 - EXECUTION (Not Used)

END OF SECTION 01 31 00

SECTION 01 32 00 - CONSTRUCTION PROGRESS DOCUMENTATION**PART 1 - GENERAL****1.1 RELATED DOCUMENTS**

- A. Drawings and general provisions of the Contract, including General and Supplementary Conditions and other Division 01 Specification Sections, apply to this Section.

1.2 SUMMARY

- A. Section includes administrative and procedural requirements for documenting the progress of construction during performance of the Work, including the following:
 - 1. Contractor's construction schedule.
 - 2. Construction schedule updating reports.
 - 3. Daily construction reports.
 - 4. Site condition reports.
 - 5. Special reports.
- B. Related Requirements:
 - 1. Division 01 Section "Submittal Procedures" for submitting schedules and reports.
 - 2. Division 01 Section "Quality Requirements" for submitting a schedule of tests and inspections.

1.3 DEFINITIONS

- A. Activity: A discrete part of a project that can be identified for planning, scheduling, monitoring, and controlling the construction project. Activities included in a construction schedule consume time and resources.
 - 1. Critical Activity: An activity on the critical path that must start and finish on the planned early start and finish times.
 - 2. Predecessor Activity: An activity that precedes another activity in the network.
 - 3. Successor Activity: An activity that follows another activity in the network.
- B. Event: The starting or ending point of an activity.

1.4 INFORMATIONAL SUBMITTALS

- A. Format for Submittals: Submit required submittals in the following format:
 - 1. PDF electronic file.
- B. Contractor's Construction Schedule: Initial schedule, of size required to display entire schedule for entire construction period.
- C. Construction Schedule Updating Reports: Submit with preliminary (pencil copy) Applications for Payment.

- D. Daily Construction Reports: Submit at weekly intervals.
- E. Site Condition Reports: Submit at time of discovery of differing conditions.
- F. Special Reports: Submit at time of unusual event.

1.5 COORDINATION

- A. Coordinate preparation and processing of schedules and reports with performance of construction activities and with scheduling and reporting of separate contractors.
- B. Coordinate Contractor's construction schedule with the schedule of values, submittal schedule, progress reports, payment requests, and other required schedules and reports.
 - 1. Secure time commitments for performing critical elements of the Work from entities involved.
 - 2. Coordinate each construction activity in the network with other activities and schedule them in proper sequence.

PART 2 - PRODUCTS

2.1 CONTRACTOR'S CONSTRUCTION SCHEDULE, GENERAL

- A. Time Frame: Extend schedule from date established for the Notice to Proceed to date of final completion.
 - 1. Contract completion date shall not be changed by submission of a schedule that shows an early completion date, unless specifically authorized by Change Order.
- B. Activities: Treat each story or separate area as a separate numbered activity for each main element of the Work. Comply with the following:
 - 1. Activity Duration: Define activities so no activity is longer than 20 days, unless specifically allowed by Architect.
 - 2. Procurement Activities: Include procurement process activities for long lead items and major items, requiring a cycle of more than 60 days, as separate activities in schedule. Procurement cycle activities include, but are not limited to, submittals, approvals, purchasing, fabrication, and delivery.
 - 3. Submittal Review Time: Include review and resubmittal times indicated in Division 01 Section "Submittal Procedures" in schedule. Coordinate submittal review times in Contractor's construction schedule with submittal schedule.
 - 4. Startup and Testing Time: Include no fewer than 15 days for startup and testing.
 - 5. Substantial Completion: Indicate completion in advance of date established for Substantial Completion, and allow time for Architect's administrative procedures necessary for certification of Substantial Completion.
 - 6. Punch List and Final Completion: Include not more than 30 days for completion of punch list items and final completion.
- C. Constraints: Include constraints and work restrictions indicated in the Contract Documents and as follows in schedule, and show how the sequence of the Work is affected.
 - 1. Phasing: Arrange list of activities on schedule by phase.
 - 2. Work under More Than One Contract: Include a separate activity for each contract.

3. Work by Owner: Include a separate activity for each portion of the Work performed by Owner.
 4. Products Ordered in Advance: Include a separate activity for each product. Include delivery date indicated in Division 01 Section "Summary." Delivery dates indicated stipulate the earliest possible delivery date.
 5. Owner-Furnished Products: Include a separate activity for each product. Include delivery date indicated in Division 01 Section "Summary." Delivery dates indicated stipulate the earliest possible delivery date.
 6. Work Restrictions: Show the effect of the following items on the schedule:
 - a. Coordination with site use limitations.
 - b. Limitations of continued occupancies of adjacent buildings.
 - c. Uninterruptible services.
 - d. Use of premises restrictions.
 - e. Environmental control.
 7. Work Stages: Indicate important stages of construction for each major portion of the Work, including, but not limited to, the following:
 - a. Subcontract awards.
 - b. Submittals.
 - c. Purchases.
 - d. Mockups.
 - e. Fabrication.
 - f. Sample testing.
 - g. Deliveries.
 - h. Installation.
 - i. Tests and inspections.
 - j. Adjusting.
 - k. Curing.
- D. Milestones: Include milestones indicated in the Contract Documents in schedule, including, but not limited to, the Notice to Proceed, Substantial Completion, final completion, and the following interim milestones:
1. Temporary enclosure and space conditioning.
 2. North parking lot access roadway completion.
- E. Recovery Schedule: When periodic update indicates the Work is 14 or more calendar days behind the current approved schedule, submit a separate recovery schedule indicating means by which Contractor intends to regain compliance with the schedule. Indicate changes to working hours, working days, crew sizes, equipment required to achieve compliance and date by which recovery will be accomplished.
- F. Computer Scheduling Software: Prepare schedules using current version of a program that has been developed specifically to manage construction schedules.
1. Use Microsoft Project for Windows XP operating system.
- 2.2 CONTRACTOR'S CONSTRUCTION SCHEDULE (GANTT CHART)
- A. Gantt-Chart Schedule: Submit a comprehensive, fully developed, horizontal, Gantt-chart-type, Contractor's construction schedule within 30 days of date established for the Notice of Award. Base schedule on the startup construction schedule and additional information received since the start of Project.

- B. Preparation: Indicate each significant construction activity separately. Identify first workday of each week with a continuous vertical line.
1. For construction activities that require two months or longer to complete, indicate an estimated completion percentage in 5 percent increments within time bar.

2.3 REPORTS

- A. Daily Construction Reports: Prepare a daily construction report recording the following information concerning events at Project site:
1. List of subcontractors at Project site.
 2. List of separate contractors at Project site.
 3. Approximate count of personnel at Project site.
 4. Equipment at Project site.
 5. Material deliveries.
 6. High and low temperatures and general weather conditions, including presence of rain or snow.
 7. Accidents.
 8. Meetings and significant decisions.
 9. Unusual events (see special reports).
 10. Stoppages, delays, shortages, and losses.
 11. Meter readings and similar recordings.
 12. Emergency procedures.
 13. Orders and requests of authorities having jurisdiction.
 14. Change Orders received and implemented.
 15. Change Directives received and implemented.
 16. Services connected and disconnected.
 17. Equipment or system tests and startups.
 18. Partial completions and occupancies.
 19. Substantial Completions authorized.
- B. Site Condition Reports: Immediately on discovery of a difference between site conditions and the Contract Documents, prepare and submit a detailed report. Submit with a Request for Information. Include a detailed description of the differing conditions, together with recommendations for changing the Contract Documents.

2.4 SPECIAL REPORTS

- A. General: Submit special reports directly to Owner within two day(s) of an occurrence. Distribute copies of report to parties affected by the occurrence.
- B. Reporting Unusual Events: When an event of an unusual and significant nature occurs at Project site, whether or not related directly to the Work, prepare and submit a special report. List chain of events, persons participating, response by Contractor's personnel, evaluation of results or effects, and similar pertinent information. Advise Owner in advance when these events are known or predictable.

PART 3 - EXECUTION**3.1 CONTRACTOR'S CONSTRUCTION SCHEDULE**

- A. Contractor's Construction Schedule Updating: At monthly intervals, update schedule to reflect actual construction progress and activities. Issue schedule one week before each regularly scheduled progress meeting.
1. Revise schedule immediately after each meeting or other activity where revisions have been recognized or made. Issue updated schedule concurrently with the report of each such meeting.
 2. Include a report with updated schedule that indicates every change, including, but not limited to, changes in logic, durations, actual starts and finishes, and activity durations.
 3. As the Work progresses, indicate final completion percentage for each activity.
- B. Distribution: Distribute copies of approved schedule to Architect, Owner, separate contractors, testing and inspecting agencies, and other parties identified by Contractor with a need-to-know schedule responsibility.
1. Post copies in Project meeting rooms and temporary field offices.
 2. When revisions are made, distribute updated schedules to the same parties and post in the same locations. Delete parties from distribution when they have completed their assigned portion of the Work and are no longer involved in performance of construction activities.

END OF SECTION 01 32 00

SECTION 01 33 00 - SUBMITTAL PROCEDURES**PART 1 - GENERAL****1.1 SUMMARY**

- A. Section includes requirements for the submittal schedule and administrative and procedural requirements for submitting Shop Drawings, Product Data, Samples, and other submittals.
- B. Related Requirements:
 - 1. Division 01 Section "Project Management and Coordination" for submitting Contractor's construction schedule.

1.2 DEFINITIONS

- A. Action Submittals: Written and graphic information and physical samples that require Architect's responsive action.
- B. Informational Submittals: Written and graphic information and physical samples that do not require Architect's responsive action. Submittals may be rejected for not complying with requirements.

1.3 SUBMITTAL ADMINISTRATIVE REQUIREMENTS

- A. Architect's Digital Data Files: Electronic copies of digital data files of the Contract Drawings will not be provided by Architect for Contractor's use in preparing submittals.
- B. Architect will not process or review submittals that have not been reviewed by the Contractor or that do not have the Contractor's review / approval stamp on them.
- C. Submittals received by Architect after 12:00 p.m. will be considered as received the following working day.
- D. Coordination: Coordinate preparation and processing of submittals with performance of construction activities.
 - 1. Coordinate each submittal with fabrication, purchasing, testing, delivery, other submittals, and related activities that require sequential activity.
 - 2. Coordinate transmittal of different types of submittals for related parts of the Work so processing will not be delayed because of need to review submittals concurrently for coordination.
 - a. Architect reserves the right to withhold action on a submittal requiring coordination with other submittals until related submittals are received.
- E. Processing Time: Allow time for submittal review, including time for resubmittals, as follows. Time for review shall commence on Architect's receipt of submittal. No extension of the Contract Time will be authorized because of failure to transmit submittals enough in advance of the Work to permit processing, including resubmittals.

1. Initial Review: Allow 15 days for initial review of each submittal. Allow additional time if coordination with subsequent submittals is required. Architect will advise Contractor when a submittal being processed must be delayed for coordination.
 - a. Allow additional 5 days for review of each submittal where it is necessary for review by Architect or Owner consultant.
 2. Intermediate Review: If intermediate submittal is necessary, process it in same manner as initial submittal.
 3. Resubmittal Review: Allow 15 days for review of each resubmittal.
 - a. Allow additional 5 days for review of each submittal where it is necessary for review by Architect or Owner consultant.
- F. Paper Submittals: Place a permanent label or title block on each submittal item for identification.
1. Indicate name of firm or entity that prepared each submittal on label or title block.
 2. Provide a space approximately 6 by 8 inches (150 by 200 mm) on label or beside title block to record Contractor's review and approval markings and action taken by Architect.
 3. Include the following information for processing and recording action taken:
 - a. Project name.
 - b. Date.
 - c. Name of Architect.
 - d. Name of Construction Manager.
 - e. Name of Contractor.
 - f. Name of subcontractor.
 - g. Name of supplier.
 - h. Name of manufacturer.
 - i. Submittal number or other unique identifier, including revision identifier.
 - 1) Submittal number shall use Specification Section number followed by a decimal point and then a sequential number (e.g., 061000.01). Resubmittals shall include an alph numeric suffix (e.g., 061000.01R1).
 - j. Number and title of appropriate Specification Section.
 - k. Drawing number and detail references, as appropriate.
 - l. Location(s) where product is to be installed, as appropriate.
 - m. Other necessary identification.
 4. Additional Paper Copies: Unless additional copies are required for final submittal, and unless Architect observes noncompliance with provisions in the Contract Documents, initial submittal may serve as final submittal.
 5. Transmittal for Paper Submittals: Assemble each submittal individually and appropriately for transmittal and handling. Transmit each submittal using a transmittal form. Architect will discard submittals received from sources other than Contractor.
 - a. Transmittal Form for Paper Submittals: Use AIA Document G810.
 - b. Transmittal Form for Paper Submittals: Provide locations on form for the following information:
 - 1) Project name.
 - 2) Date.
 - 3) Destination (To:).
 - 4) Source (From:).

- 5) Name and address of Architect.
 - 6) Name of Construction Manager.
 - 7) Name of Contractor.
 - 8) Name of firm or entity that prepared submittal.
 - 9) Names of subcontractor, manufacturer, and supplier.
 - 10) Category and type of submittal.
 - 11) Submittal purpose and description.
 - 12) Specification Section number and title.
 - 13) Specification paragraph number or drawing designation and generic name for each of multiple items.
 - 14) Drawing number and detail references, as appropriate.
 - 15) Indication of full or partial submittal.
 - 16) Transmittal number, numbered consecutively.
 - 17) Submittal and transmittal distribution record.
 - 18) Remarks.
 - 19) Signature of transmitter.
- G. Options: Identify options requiring selection by Architect.
- H. Deviations: Identify deviations from the Contract Documents on submittals.
- I. Resubmittals: Make resubmittals in same form and number of copies as initial submittal.
1. Note date and content of previous submittal.
 2. Note date and content of revision in label or title block and clearly indicate extent of revision.
 3. Resubmit submittals until they are marked with approval notation from Architect's action stamp.
- J. Distribution: Furnish copies of final submittals to manufacturers, subcontractors, suppliers, fabricators, installers, authorities having jurisdiction, and others as necessary for performance of construction activities. Show distribution on transmittal forms.
- K. Use for Construction: Retain complete copies of submittals on Project site. Use only final action submittals that are marked with approval notation from Architect's action stamp.

PART 2 - PRODUCTS

2.1 SUBMITTAL PROCEDURES

- A. General Submittal Procedure Requirements:
1. Action Submittals: Submit five paper copies of each submittal unless otherwise indicated. Architect will return two copies.
 2. Informational Submittals: Submit three paper copies of each submittal unless otherwise indicated. Architect will not return copies.
 3. Certificates and Certifications Submittals: Provide a statement that includes signature of entity responsible for preparing certification. Certificates and certifications shall be signed by an officer or other individual authorized to sign documents on behalf of that entity.
 - a. Provide a notarized statement on original paper copy certificates and certifications where indicated.

- B. Product Data: Collect information into a single submittal for each element of construction and type of product or equipment.
1. If information must be specially prepared for submittal because standard published data are not suitable for use, submit as Shop Drawings, not as Product Data.
 2. Mark each copy of each submittal to show which products and options are applicable.
 3. Include the following information, as applicable:
 - a. Manufacturer's catalog cuts.
 - b. Manufacturer's product specifications.
 - c. Standard color charts.
 - d. Statement of compliance with specified referenced standards.
 - e. Testing by recognized testing agency.
 - f. Application of testing agency labels and seals.
 - g. Notation of coordination requirements.
 - h. Availability and delivery time information.
 4. For equipment, include the following in addition to the above, as applicable:
 - a. Wiring diagrams showing factory-installed wiring.
 - b. Printed performance curves.
 - c. Operational range diagrams.
 - d. Clearances required to other construction, if not indicated on accompanying Shop Drawings.
 5. Submit Product Data before or concurrent with Samples.
 6. Submit Product Data in the following format:
 - a. Five paper copies of Product Data unless otherwise indicated. Architect will return two copies.
- C. Shop Drawings: Prepare Project-specific information, drawn accurately to scale. Do not base Shop Drawings on reproductions of the Contract Documents or standard printed data.
1. Preparation: Fully illustrate requirements in the Contract Documents. Include the following information, as applicable:
 - a. Identification of products.
 - b. Schedules.
 - c. Compliance with specified standards.
 - d. Notation of coordination requirements.
 - e. Notation of dimensions established by field measurement.
 - f. Relationship and attachment to adjoining construction clearly indicated.
 - g. Seal and signature of professional engineer if specified.
 2. Sheet Size: Except for templates, patterns, and similar full-size drawings, submit Shop Drawings on sheets at least 8-1/2 by 11 inches (215 by 280 mm), but no larger than 30 by 42 inches (750 by 1067 mm).
 3. Submit Shop Drawings in the following format:
 - a. Five opaque copies of each submittal. Architect will retain three copies; remainder will be returned.
- D. Samples: Submit Samples for review of kind, color, pattern, and texture for a check of these characteristics with other elements and for a comparison of these characteristics between submittal and actual component as delivered and installed.

1. Transmit Samples that contain multiple, related components such as accessories together in one submittal package.
 2. Identification: Attach label on unexposed side of Samples that includes the following:
 - a. Generic description of Sample.
 - b. Product name and name of manufacturer.
 - c. Sample source.
 - d. Number and title of applicable Specification Section.
 3. Disposition: Maintain sets of approved Samples at Project site, available for quality-control comparisons throughout the course of construction activity. Sample sets may be used to determine final acceptance of construction associated with each set.
 - a. Samples that may be incorporated into the Work are indicated in individual Specification Sections. Such Samples must be in an undamaged condition at time of use.
 - b. Samples not incorporated into the Work, or otherwise designated as Owner's property, are the property of Contractor.
 4. Samples for Initial Selection: Submit manufacturer's color charts consisting of units or sections of units showing the full range of colors, textures, and patterns available.
 - a. Number of Samples: Submit two full set(s) of available choices where color, pattern, texture, or similar characteristics are required to be selected from manufacturer's product line. Architect will return submittal with options selected.
 5. Samples for Verification: Submit full-size units or Samples of size indicated, prepared from same material to be used for the Work, cured and finished in manner specified, and physically identical with material or product proposed for use, and that show full range of color and texture variations expected. Samples include, but are not limited to, the following: partial sections of manufactured or fabricated components; small cuts or containers of materials; complete units of repetitively used materials; swatches showing color, texture, and pattern; color range sets; and components used for independent testing and inspection.
 - a. Number of Samples: Submit three sets of Samples. Architect will retain two Sample sets; remainder will be returned. Mark up and retain one returned Sample set as a project record sample.
 - 1) If variation in color, pattern, texture, or other characteristic is inherent in material or product represented by a Sample, submit at least three sets of paired units that show approximate limits of variations.
- E. Product Schedule: As required in individual Specification Sections, prepare a written summary indicating types of products required for the Work and their intended location. Include the following information in tabular form:
1. Submit product schedule in the following format:
 - a. Four paper copies of product schedule or list unless otherwise indicated. Architect will return two copies.
- F. Coordination Drawings Submittals: Comply with requirements specified in Division 01 Section "Project Management and Coordination."
- G. Contractor's Construction Schedule: Comply with requirements specified in Division 01 Section "Project Management and Coordination."

- H. Application for Payment and Schedule of Values: Comply with requirements specified in Division 01 Section "Summary."
- I. Test and Inspection Reports and Schedule of Tests and Inspections Submittals: Comply with requirements specified in Division 01 Section "Quality Requirements."
- J. Closeout Submittals and Maintenance Material Submittals: Comply with requirements specified in Division 01 Section "Closeout Procedures."
- K. Maintenance Data: Comply with requirements specified in Division 01 Section "Operation and Maintenance Data."
- L. Qualification Data: Prepare written information that demonstrates capabilities and experience of firm or person. Include lists of completed projects with project names and addresses, contact information of architects and owners, and other information specified.
- M. Welding Certificates: Prepare written certification that welding procedures and personnel comply with requirements in the Contract Documents. Submit record of Welding Procedure Specification and Procedure Qualification Record on AWS forms. Include names of firms and personnel certified.
- N. Installer Certificates: Submit written statements on manufacturer's letterhead certifying that Installer complies with requirements in the Contract Documents and, where required, is authorized by manufacturer for this specific Project.
- O. Manufacturer Certificates: Submit written statements on manufacturer's letterhead certifying that manufacturer complies with requirements in the Contract Documents. Include evidence of manufacturing experience where required.
- P. Product Certificates: Submit written statements on manufacturer's letterhead certifying that product complies with requirements in the Contract Documents.
- Q. Material Certificates: Submit written statements on manufacturer's letterhead certifying that material complies with requirements in the Contract Documents.
- R. Material Test Reports: Submit reports written by a qualified testing agency, on testing agency's standard form, indicating and interpreting test results of material for compliance with requirements in the Contract Documents.
- S. Product Test Reports: Submit written reports indicating that current product produced by manufacturer complies with requirements in the Contract Documents. Base reports on evaluation of tests performed by manufacturer and witnessed by a qualified testing agency, or on comprehensive tests performed by a qualified testing agency.
- T. Research Reports: Submit written evidence, from a model code organization acceptable to authorities having jurisdiction, that product complies with building code in effect for Project.
- U. Schedule of Tests and Inspections: Comply with requirements specified in Division 01 Section "Quality Requirements."
- V. Preconstruction Test Reports: Submit reports written by a qualified testing agency, on testing agency's standard form, indicating and interpreting results of tests performed before installation of product, for compliance with performance requirements in the Contract Documents.
- W. Compatibility Test Reports: Submit reports written by a qualified testing agency, on testing agency's standard form, indicating and interpreting results of compatibility tests performed

before installation of product. Include written recommendations for primers and substrate preparation needed for adhesion.

- X. Field Test Reports: Submit written reports indicating and interpreting results of field tests performed either during installation of product or after product is installed in its final location, for compliance with requirements in the Contract Documents.

2.2 DELEGATED-DESIGN SERVICES

- A. Performance and Design Criteria: Where professional design services or certifications by a design professional are specifically required of Contractor by the Contract Documents, provide products and systems complying with specific performance and design criteria indicated.
 - 1. If criteria indicated are not sufficient to perform services or certification required, submit a written request for additional information to Architect.
- B. Delegated-Design Services Certification: In addition to Shop Drawings, Product Data, and other required submittals, submit digitally signed PDF electronic file and five paper copies of certificate, signed and sealed by the responsible design professional, for each product and system specifically assigned to Contractor to be designed or certified by a design professional.
 - 1. Indicate that products and systems comply with performance and design criteria in the Contract Documents. Include list of codes, loads, and other factors used in performing these services.

PART 3 - EXECUTION

3.1 CONTRACTOR'S REVIEW

- A. Action and Informational Submittals: Review each submittal and check for coordination with other Work of the Contract and for compliance with the Contract Documents. Note corrections and field dimensions. Mark with approval stamp before submitting to Architect.
 - 1. Contractor shall clearly identify "any" and "all" deviations from the contract documents.
 - 2. Contractor shall clearly identify items which need clarification with other trades than the trade submitting the submittal.
 - 3. Contractor shall clearly identify "any" and "all" modifications to the contract documents required by the submittal.
- B. Resubmittals shall have "all" changes, modifications, etc. clearly identified. Failure to identify changes, modifications, etc. shall be justification for returning the submittal without A/E review.
- C. Project Closeout and Maintenance Material Submittals: See requirements in Division 01 Section "Closeout Procedures."
- D. Approval Stamp: Stamp each submittal with a uniform, approval stamp. Include Project name and location, submittal number, Specification Section title and number, name of reviewer, date of Contractor's approval, and statement certifying that submittal has been reviewed, checked, and approved for compliance with the Contract Documents.
- E. Failure of Contractor to properly review or stamp submittal shall be justification for returning the submittal without A/E review.

- F. Contractor shall submit documents required by authorities having jurisdiction and obtain their approvals prior to submission to the Architect.

3.2 ARCHITECT'S ACTION

- A. General: Architect will not review submittals that do not bear Contractor's approval stamp and will return them without action.
- B. Action Submittals: Architect will review each submittal, make marks to indicate corrections or revisions required, and return it. Architect will stamp each submittal with an action stamp and will mark stamp appropriately to indicate action.
- C. Informational Submittals: Architect will review each submittal and will not return it, or will return it if it does not comply with requirements. Architect will forward each submittal to appropriate party.
- D. Incomplete submittals are unacceptable, will be considered nonresponsive, and will be returned for resubmittal without review.
- E. Submittals not required by the Contract Documents may not be reviewed and may be discarded.

END OF SECTION 01 33 00

SECTION 01 40 00 - QUALITY REQUIREMENTS**PART 1 - GENERAL****1.1 RELATED DOCUMENTS**

- A. Drawings and general provisions of the Contract, including General and Supplementary Conditions and other Division 1 Specification Sections, apply to this Section.

1.2 SUMMARY

- A. This Section includes administrative and procedural requirements for quality assurance and quality control.
- B. Testing and inspecting services are required to verify compliance with requirements specified or indicated. These services do not relieve Contractor of responsibility for compliance with the Contract Document requirements.
 - 1. Specific quality-assurance and -control requirements for individual construction activities are specified in the Sections that specify those activities. Requirements in those Sections may also cover production of standard products.
 - 2. Specified tests, inspections, and related actions do not limit Contractor's other quality-assurance and -control procedures that facilitate compliance with the Contract Document requirements.
 - 3. Requirements for Contractor to provide quality-assurance and -control services required by Architect, Owner, or authorities having jurisdiction are not limited by provisions of this Section.
- C. The contractor is responsible for the overall quality of all its own work and the work performed by the subcontractors working under this contract. The quality of any part of the work installed must not be less than that required by the contract documents. If the Architect or Owner determines that the quality of work does not conform to the applicable specifications and drawings, the contractor will be advised in writing of the areas of nonconformance and within 24 hours the contractor must correct the deficiencies and advise the Architect and Owner in writing of the corrective action taken.
- D. Related Sections include the following:
 - 1. Divisions 23 through 26 Sections for specific test and inspection requirements.

1.3 DEFINITIONS

- A. **Quality-Assurance Services:** Activities, actions, and procedures performed before and during execution of the Work to guard against defects and deficiencies and substantiate that proposed construction will comply with requirements.
- B. **Quality-Control Services:** Tests, inspections, procedures, and related actions during and after execution of the Work to evaluate that actual products incorporated into the Work and completed construction comply with requirements. Services do not include contract enforcement activities performed by Architect.

- C. **Mockups:** Full-size physical assemblies that are constructed on-site. Mockups are constructed to verify selections made under Sample submittals; to demonstrate aesthetic effects and, where indicated, qualities of materials and execution; to review coordination, testing, or operation; to show interface between dissimilar materials; and to demonstrate compliance with specified installation tolerances. Mockups are not Samples. Unless otherwise indicated, approved mockups establish the standard by which the Work will be judged.
1. **Integrated Exterior Mockups:** Mockups of the exterior envelope erected separately from the building but on Project site, consisting of multiple products, assemblies, and subassemblies.
- D. **Preconstruction Testing:** Tests and inspections performed specifically for Project before products and materials are incorporated into the Work, to verify performance or compliance with specified criteria.
- E. **Product Testing:** Tests and inspections that are performed by an NRTL, an NVLAP, or a testing agency qualified to conduct product testing and acceptable to authorities having jurisdiction, to establish product performance and compliance with industry standards.
- F. **Source Quality-Control Testing:** Tests and inspections that are performed at the source, i.e., plant, mill, factory, or shop.
- G. **Field Quality-Control Testing:** Tests and inspections that are performed on-site for installation of the Work and for completed Work.
- H. **Testing Agency:** An entity engaged to perform specific tests, inspections, or both. Testing laboratory shall mean the same as testing agency.
- I. **Installer/Applicator/Erector:** Contractor or another entity engaged by Contractor as an employee, Subcontractor, or Sub-subcontractor, to perform a particular construction operation, including installation, erection, application, and similar operations.
1. Using a term such as "carpentry" does not imply that certain construction activities must be performed by accredited or unionized individuals of a corresponding generic name, such as "carpenter." It also does not imply that requirements specified apply exclusively to tradespeople of the corresponding generic name.
- J. **Experienced:** When used with an entity or individual, "experienced" means having successfully completed a minimum of five previous projects similar in nature, size, and extent to this Project; being familiar with special requirements indicated; and having complied with requirements of authorities having jurisdiction. If individual specification sections require a higher minimum experience requirement that requirement shall supersede this subparagraph.

1.4 CONFLICTING REQUIREMENTS

- A. **General:** If compliance with two or more standards is specified and the standards establish different or conflicting requirements for minimum quantities or quality levels, comply with the most stringent requirement. Refer uncertainties and requirements that are different, but apparently equal, to Architect for a decision before proceeding.
- B. **Minimum Quantity or Quality Levels:** The quantity or quality level shown or specified shall be the minimum provided or performed. The actual installation may comply exactly with the minimum quantity or quality specified, or it may exceed the minimum within reasonable limits. To comply with these requirements, indicated numeric values are minimum or

maximum, as appropriate, for the context of requirements. Refer uncertainties to Architect for a decision before proceeding.

1.5 ACTION SUBMITTALS

- A. Shop Drawings: For integrated exterior mockups, provide plans, sections, and elevations, indicating materials and size of mockup construction.
 - 1. Indicate manufacturer and model number of individual components.
 - 2. Provide axonometric drawings for conditions difficult to illustrate in two dimensions.

1.6 INFORMATIONAL SUBMITTALS

- A. Contractor's Quality-Control Plan: For quality-assurance and quality-control activities and responsibilities.
- B. Qualification Data : For Contractor's quality-control personnel.
- C. Contractor's Statement of Responsibility: When required by applicable building code, authorities having jurisdiction or the contract documents submit copy of written statement of responsibility sent to authorities having jurisdiction before starting work on the following systems:
 - 1. Seismic-force-resisting system, designated seismic system, or component listed in the designated seismic system quality-assurance plan prepared by Architect.
 - 2. Main wind-force-resisting system or a wind-resisting component listed in the wind-force-resisting system quality-assurance plan prepared by Architect.
- D. Testing Agency Qualifications: For testing agencies specified in "Quality Assurance" Article to demonstrate their capabilities and experience. Include proof of qualifications in the form of a recent report on the inspection of the testing agency by a recognized authority.
- E. Schedule of Tests and Inspections: Prepare in tabular form and include the following:
 - 1. Specification Section number and title.
 - 2. Entity responsible for performing tests and inspections.
 - 3. Description of test and inspection.
 - 4. Identification of applicable standards.
 - 5. Identification of test and inspection methods.
 - 6. Number of tests and inspections required.
 - 7. Time schedule or time span for tests and inspections.
 - 8. Requirements for obtaining samples.
 - 9. Unique characteristics of each quality-control service.
- F. Reports: Prepare and submit certified written reports that include the following:
 - 1. Date of issue.
 - 2. Project title and number.
 - 3. Name, address, and telephone number of testing agency.
 - 4. Dates and locations of samples and tests or inspections.
 - 5. Names of individuals making tests and inspections.
 - 6. Description of the Work and test and inspection method.
 - 7. Identification of product and Specification Section.
 - 8. Complete test or inspection data.

9. Test and inspection results and an interpretation of test results.
10. Record of temperature and weather conditions at time of sample taking and testing and inspecting.
11. Comments or professional opinion on whether tested or inspected Work complies with the Contract Document requirements.
12. Name and signature of laboratory inspector.
13. Recommendations on retesting and reinspecting.

- G. Permits, Licenses, and Certificates: For Owner's records, submit copies of permits, licenses, certifications, inspection reports, releases, jurisdictional settlements, notices, receipts for fee payments, judgments, correspondence, records, and similar documents, established for compliance with standards and regulations bearing on performance of the Work.

1.7 QUALITY ASSURANCE

- A. General: Qualifications paragraphs in this Article establish the minimum qualification levels required; individual Specification Sections specify additional requirements.
- B. Installer Qualifications: A firm or individual experienced in installing, erecting, or assembling work similar in material, design, and extent to that indicated for this Project, whose work has resulted in construction with a record of successful in-service performance.
- C. Manufacturer Qualifications: A firm experienced in manufacturing products or systems similar to those indicated for this Project and with a record of successful in-service performance, as well as sufficient production capacity to produce required units.
- D. Fabricator Qualifications: A firm experienced in producing products similar to those indicated for this Project and with a record of successful in-service performance, as well as sufficient production capacity to produce required units.
- E. Professional Engineer Qualifications: A professional engineer who is legally qualified to practice in jurisdiction where Project is located and who is experienced in providing engineering services of the kind indicated. Engineering services are defined as those performed for installations of the system, assembly, or product that are similar to those indicated for this Project in material, design, and extent.
- F. Specialists: Certain sections of the Specifications require that specific construction activities shall be performed by entities who are recognized experts in those operations. Specialists shall satisfy qualification requirements indicated and shall be engaged for the activities indicated.
1. Requirement for specialists shall not supersede building codes and regulations governing the Work.
- G. Testing Agency Qualifications: An NRTL, an NVLAP, or an independent agency with the experience and capability to conduct testing and inspecting indicated, as documented according to ASTM E 548; and with additional qualifications specified in individual Sections; and where required by authorities having jurisdiction, that is acceptable to authorities.
1. NRTL: A nationally recognized testing laboratory according to 29 CFR 1910.7.
 2. NVLAP: A testing agency accredited according to NIST's National Voluntary Laboratory Accreditation Program.

- H. **Factory-Authorized Service Representative Qualifications:** An authorized representative of manufacturer who is trained and approved by manufacturer to inspect installation of manufacturer's products that are similar in material, design, and extent to those indicated for this Project.
- I. **Preconstruction Testing:** Where testing agency is indicated to perform preconstruction testing for compliance with specified requirements for performance and test methods, comply with the following:
1. Contractor responsibilities include the following:
 - a. Provide test specimens representative of proposed products and construction.
 - b. Submit specimens in a timely manner with sufficient time for testing and analyzing results to prevent delaying the Work.
 - c. Provide sizes and configurations of test assemblies, mockups, and laboratory mockups to adequately demonstrate capability of products to comply with performance requirements.
 - d. Build site-assembled test assemblies and mockups using installers who will perform same tasks for Project.
 - e. Build laboratory mockups at testing facility using personnel, products, and methods of construction indicated for the completed Work.
 - f. When testing is complete, remove test specimens, assemblies, mockups, and laboratory mockups; do not reuse products on Project.
 2. **Testing Agency Responsibilities:** Submit a certified written report of each test, inspection, and similar quality-assurance service to Architect, with copy to Contractor. Interpret tests and inspections and state in each report whether tested and inspected work complies with or deviates from the Contract Documents.

1.8 QUALITY CONTROL

- A. **Special Tests and Inspections:** Owner will engage a qualified testing agency and special inspector to conduct special tests and inspections per the requirements of Chapter 17 of the Rhode Island State Building Code as the responsibility of the Owner as indicated in the Statement of Special Inspections attached to this Section and as follows:
1. Verifying that manufacturer maintains detailed fabrication and quality-control procedures and reviewing the completeness and adequacy of those procedures to perform the Work.
 2. Notifying Architect and Contractor promptly of irregularities and deficiencies observed in the Work during performance of its services.
 3. Submitting a certified written report of each test, inspection, and similar quality-control service to Architect with copy to Contractor and to authorities having jurisdiction.
 4. Submitting a final report of special tests and inspections at Substantial Completion, which includes a list of unresolved deficiencies.
 5. Interpreting tests and inspections and stating in each report whether tested and inspected work complies with or deviates from the Contract Documents.
 6. Retesting and reinspecting corrected work. Costs for retesting and reinspecting construction that replaces or is necessitated by work that failed to comply with the Contract Documents will be charged to Contractor.
- B. Owner will furnish Contractor with names, addresses, and telephone numbers of testing agencies engaged and a description of types of testing and inspecting they are engaged to perform.

- C. Tests and inspections not explicitly assigned to Owner are Contractor's responsibility. Unless otherwise indicated, provide quality-control services specified and those required by authorities having jurisdiction. Perform quality-control services required of Contractor by authorities having jurisdiction, whether specified or not.
1. Where services are indicated as Contractor's responsibility, engage a qualified testing agency to perform these quality-control services.
 - a. Contractor shall not employ same entity engaged by Owner, unless agreed to in writing by Owner.
 2. Notify testing agencies at least 24 hours in advance of time when Work that requires testing or inspecting will be performed.
 3. Where quality-control services are indicated as Contractor's responsibility, submit a certified written report, in duplicate, of each quality-control service.
 4. Testing and inspecting requested by Contractor and not required by the Contract Documents are Contractor's responsibility.
 5. Submit additional copies of each written report directly to authorities having jurisdiction, when they so direct.
- D. Manufacturer's Field Services: Where indicated, engage a factory-authorized service representative to inspect field-assembled components and equipment installation, including service connections. Report results in writing as specified in Division 1 Section "Submittal Procedures."
- E. Retesting/Reinspecting: Regardless of whether original tests or inspections were Contractor's responsibility, provide quality-control services, including retesting and reinspecting, for construction that replaced Work that failed to comply with the Contract Documents.
1. All costs associated with retesting shall be the responsibility of the Contractor.
- F. Testing Agency Responsibilities: Cooperate with Architect and Contractor in performance of duties. Provide qualified personnel to perform required tests and inspections.
1. Notify Architect and Contractor promptly of irregularities or deficiencies observed in the Work during performance of its services.
 2. Determine the location from which test samples will be taken and in which in-situ tests are conducted.
 3. Conduct and interpret tests and inspections and state in each report whether tested and inspected work complies with or deviates from requirements.
 4. Submit a certified written report, in duplicate, of each test, inspection, and similar quality-control service through Contractor.
 5. Do not release, revoke, alter, or increase the Contract Document requirements or approve or accept any portion of the Work.
 6. Do not perform any duties of Contractor.
- G. Associated Services: Cooperate with Owner's special inspector, testing agency and other agencies performing required tests, inspections, and similar quality-control services, and provide reasonable auxiliary services as requested. Notify agency sufficiently in advance of operations to permit assignment of personnel. Provide the following:
1. Access to the Work.
 2. Incidental labor and facilities necessary to facilitate tests and inspections.
 3. Adequate quantities of representative samples of materials that require testing and inspecting. Assist agency in obtaining samples.
 4. Facilities for storage and field curing of test samples.
 5. Delivery of samples to testing agencies.

6. Preliminary design mix proposed for use for material mixes that require control by testing agency.
 7. Security and protection for samples and for testing and inspecting equipment at Project site.
- H. Coordination: Coordinate sequence of activities to accommodate required quality-assurance and -control services with a minimum of delay and to avoid necessity of removing and replacing construction to accommodate testing and inspecting.
1. Schedule times for tests, inspections, obtaining samples, and similar activities.

PART 2 - PRODUCTS (Not Used)

PART 3 - EXECUTION

3.1 TEST AND INSPECTION LOG

- A. Prepare a record of tests and inspections. Include the following:
1. Date test or inspection was conducted.
 2. Description of the Work tested or inspected.
 3. Date test or inspection results were transmitted to Architect.
 4. Identification of testing agency or special inspector conducting test or inspection.
- B. Maintain log at Project site. Post changes and modifications as they occur. Provide access to test and inspection log for Architect's reference during normal working hours.

3.2 REPAIR AND PROTECTION

- A. General: On completion of testing, inspecting, sample taking, and similar services, repair damaged construction and restore substrates and finishes.
1. Provide materials and comply with installation requirements specified in other Specification Sections. Restore patched areas and extend restoration into adjoining areas with durable seams that are as invisible as possible.
 2. Comply with the Contract Document requirements for cutting and patching in Division 01 Section "Execution."
- B. Protect construction exposed by or for quality-control service activities.
- C. Repair and protection are Contractor's responsibility, regardless of the assignment of responsibility for quality-control services.

END OF SECTION 01 40 00

SECTION 01 60 00 - PRODUCT REQUIREMENTS**PART 1 - GENERAL****1.1 RELATED DOCUMENTS**

- A. Drawings and general provisions of the Contract, including General and Supplementary Conditions and other Division 01 Specification Sections, apply to this Section.

1.2 SUMMARY

- A. Section includes administrative and procedural requirements for selection of products for use in Project; product delivery, storage, and handling; manufacturers' standard warranties on products; special warranties; comparable products and substitutions.
- B. Related Requirements:
 - 1. Division 01 for applicable industry standards for products specified.

1.3 DEFINITIONS

- A. Products: Items obtained for incorporating into the Work, whether purchased for Project or taken from previously purchased stock. The term "product" includes the terms "material," "equipment," "system," and terms of similar intent.
 - 1. Named Products: Items identified by manufacturer's product name, including make or model number or other designation shown or listed in manufacturer's published product literature, which is current as of date of the Contract Documents.
 - 2. New Products: Items that have not previously been incorporated into another project or facility. Products salvaged or recycled from other projects are not considered new products.
 - 3. Comparable Product: Product that is demonstrated and approved through submittal process to have the indicated qualities related to type, function, dimension, in-service performance, physical properties, appearance, and other characteristics that equal or exceed those of specified product.
- B. Basis-of-Design Product Specification: A specification in which a specific manufacturer's product is named and accompanied by the words "basis-of-design product," including make or model number or other designation, to establish the significant qualities related to type, function, dimension, in-service performance, physical properties, appearance, and other characteristics for purposes of evaluating comparable products of additional manufacturers named in the specification.
- C. Substitutions: Changes in products, materials, equipment, and methods of construction from those required by the Contract Documents and proposed by Contractor.
 - 1. Substitutions for Cause: Changes proposed by Contractor that are required due to changed Project conditions, such as unavailability of product, regulatory changes, or unavailability of required warranty terms.
 - 2. Substitutions for Convenience: Changes proposed by Contractor or Owner that are not required in order to meet other Project requirements but may offer advantage to Contractor or Owner.

1.4 ACTION SUBMITTALS

- A. Comparable Product Requests: Submit request for consideration of each comparable product. Identify product or fabrication or installation method to be replaced. Include Specification Section number and title and Drawing numbers and titles.
1. Include data to indicate compliance with the requirements specified in "Comparable Products" Article.
 2. Architect's Action: If necessary, Architect will request additional information or documentation for evaluation within one week of receipt of a comparable product request. Architect will notify Contractor of approval or rejection of proposed comparable product request within 15 days of receipt of request, or seven days of receipt of additional information or documentation, whichever is later.
 - a. Form of Approval: As specified in Division 01 Section "Submittal Procedures."
 - b. Use product specified if Architect does not issue a decision on use of a comparable product request within time allocated.
- B. Basis-of-Design Product Specification Submittal: Comply with requirements in Division 01 Section "Submittal Procedures." Show compliance with requirements.
- C. Substitution Requests: Submit three copies of each request for consideration. Identify product or fabrication or installation method to be replaced. Include Specification Section number and title and Drawing numbers and titles.
1. Substitution Request Form: Use CSI Form 13.1A or another form that is acceptable to the Architect.
 2. Form shall be sent to Architect in both hardcopy and electronic file form so that Architect may respond back to Contractor electronically.
 3. Documentation: Show compliance with requirements for substitutions and the following, as applicable:
 - a. Statement indicating why specified product or fabrication or installation cannot be provided, if applicable.
 - b. Coordination information, including a list of changes or revisions needed to other parts of the Work and to construction performed by Owner and separate contractors, that will be necessary to accommodate proposed substitution.
 - c. Detailed comparison of significant qualities of proposed substitution with those of the Work specified. Include annotated copy of applicable Specification Section. Significant qualities may include attributes such as performance, weight, size, durability, visual effect, sustainable design characteristics, warranties, and specific features and requirements indicated. Indicate deviations, if any, from the Work specified.
 - d. Product Data, including drawings and descriptions of products and fabrication and installation procedures.
 - e. Samples, where applicable or requested.
 - f. Certificates and qualification data, where applicable or requested.
 - g. List of similar installations for completed projects with project names and addresses and names and addresses of architects and owners.
 - h. Material test reports from a qualified testing agency indicating and interpreting test results for compliance with requirements indicated.
 - i. Research reports evidencing compliance with building code in effect for Project, from ICC-ES.
 - j. Detailed comparison of Contractor's construction schedule using proposed substitution with products specified for the Work, including effect on the overall Contract Time. If specified product or method of construction cannot be provided within the Contract Time, include letter from manufacturer, on

- manufacturer's letterhead, stating date of receipt of purchase order, lack of availability, or delays in delivery.
- k. Cost information, including a proposal of change, if any, in the Contract Sum.
 - l. Contractor's certification that proposed substitution complies with requirements in the Contract Documents except as indicated in substitution request, is compatible with related materials, and is appropriate for applications indicated.
 - m. Contractor's waiver of rights to additional payment or time that may subsequently become necessary because of failure of proposed substitution to produce indicated results.
4. Architect's Action: If necessary, Architect will request additional information or documentation for evaluation within seven days of receipt of a request for substitution. Architect will notify Contractor of acceptance or rejection of proposed substitution within 15 days of receipt of request, or seven days of receipt of additional information or documentation, whichever is later.
- a. Forms of Acceptance: Change Order, Construction Change Directive, or Architect's Supplemental Instructions for minor changes in the Work.
 - b. Use product specified if Architect does not issue a decision on use of a proposed substitution within time allocated.

1.5 QUALITY ASSURANCE

- A. Compatibility of Options: If Contractor is given option of selecting between two or more products for use on Project, select product compatible with products previously selected, even if previously selected products were also options.

1.6 PRODUCT DELIVERY, STORAGE, AND HANDLING

- A. Deliver, store, and handle products using means and methods that will prevent damage, deterioration, and loss, including theft and vandalism. Comply with manufacturer's written instructions.
- B. Delivery and Handling:
 - 1. Schedule delivery to minimize long-term storage at Project site and to prevent overcrowding of construction spaces.
 - 2. Coordinate delivery with installation time to ensure minimum holding time for items that are flammable, hazardous, easily damaged, or sensitive to deterioration, theft, and other losses.
 - 3. Deliver products to Project site in an undamaged condition in manufacturer's original sealed container or other packaging system, complete with labels and instructions for handling, storing, unpacking, protecting, and installing.
 - 4. Inspect products on delivery to determine compliance with the Contract Documents and to determine that products are undamaged and properly protected.
- C. Storage:
 - 1. Store products to allow for inspection and measurement of quantity or counting of units.
 - 2. Store materials in a manner that will not endanger Project structure.
 - 3. Store products that are subject to damage by the elements, under cover in a weathertight enclosure above ground, with ventilation adequate to prevent condensation.

4. Protect foam plastic from exposure to sunlight, except to extent necessary for period of installation and concealment.
5. Comply with product manufacturer's written instructions for temperature, humidity, ventilation, and weather-protection requirements for storage.
6. Protect stored products from damage and liquids from freezing.
7. Provide a secure location and enclosure at Project site for storage of materials and equipment by Owner's construction forces. Coordinate location with Owner.

1.7 PRODUCT WARRANTIES

- A. Warranties specified in other Sections shall be in addition to, and run concurrent with, other warranties required by the Contract Documents. Manufacturer's disclaimers and limitations on product warranties do not relieve Contractor of obligations under requirements of the Contract Documents.
 1. Manufacturer's Warranty: Written warranty furnished by individual manufacturer for a particular product and specifically endorsed by manufacturer to Owner.
 2. Special Warranty: Written warranty required by the Contract Documents to provide specific rights for Owner.
- B. Special Warranties: Prepare a written document that contains appropriate terms and identification, ready for execution.
 1. Manufacturer's Standard Form: Modified to include Project-specific information and properly executed.
 2. Specified Form: When specified forms are included with the Specifications, prepare a written document using indicated form properly executed.
 3. See Divisions 02 through 33 Sections for specific content requirements and particular requirements for submitting special warranties.
- C. Submittal Time: Comply with requirements in Division 01 Section "Closeout Procedures."

1.8 SUBSTITUTIONS

- A. Limitations on substitutions:
 1. During Bidding period, Instructions to Bidders govern times for submitting requests for substitutions under requirements specified in this Section.
 2. Substitutions will not be considered when indicated on shop drawings or product data submittals without separate formal request, when requested directly by subcontractor or supplier, or when acceptance will require substantial revision of Contract Documents.
 3. Substitute products shall not be ordered or installed without written acceptance.
 4. Only one request for substitution for each product will be considered. When substitution is not accepted, provide specified product.
 5. Architect has sole right of determination of acceptability of substitutions.
 6. A contractor or subcontractor who carries the cost of a substitute in his bid without prior review by the Architect, does so at his own risk. The Owner is no way obligated to review nor allow that a speculative substitution be furnished.

PART 2 - PRODUCTS**2.1 PRODUCT SELECTION PROCEDURES**

- A. General Product Requirements: Provide products that comply with the Contract Documents, are undamaged and, unless otherwise indicated, are new at time of installation.
1. Provide products complete with accessories, trim, finish, fasteners, and other items needed for a complete installation and indicated use and effect.
 2. Standard Products: If available, and unless custom products or nonstandard options are specified, provide standard products of types that have been produced and used successfully in similar situations on other projects.
 3. Owner reserves the right to limit selection to products with warranties not in conflict with requirements of the Contract Documents.
 4. Where products are accompanied by the term "as selected," Architect will make selection.
 5. Descriptive, performance, and reference standard requirements in the Specifications establish salient characteristics of products.
 6. Or Equal: For products specified by name and accompanied by the term "or equal," or "or approved equal," or "or approved," comply with requirements in "Comparable Products" Article to obtain approval for use of an unnamed product.
- B. Product Selection Procedures:
1. Product: Where Specifications name a single manufacturer and product, provide the named product that complies with requirements. Comparable products or substitutions for Contractor's convenience will not be considered.
 2. Manufacturer/Source: Where Specifications name a single manufacturer or source, provide a product by the named manufacturer or source that complies with requirements. Comparable products or substitutions for Contractor's convenience will not be considered.
 3. Products:
 - a. Where Specifications include a list of names of both manufacturers and products, provide one of the products listed that complies with requirements. Comparable products or substitutions for Contractor's convenience will not be considered unless otherwise indicated.
 4. Manufacturers:
 - a. Restricted List: Where Specifications include a list of manufacturers' names, provide a product by one of the manufacturers listed that complies with requirements. Comparable products or substitutions for Contractor's convenience will not be considered unless otherwise indicated.
 5. Basis-of-Design Product: Where Specifications name a product, or refer to a product indicated on Drawings, and include a list of manufacturers, provide the specified or indicated product or a comparable product by one of the other named manufacturers. Drawings and Specifications indicate sizes, profiles, dimensions, and other characteristics that are based on the product named. Comply with requirements in "Comparable Products" Article for consideration of an unnamed product by one of the other named manufacturers.

- C. Visual Matching Specification: Where Specifications require "match Architect's sample", provide a product that complies with requirements and matches Architect's sample. Architect's decision will be final on whether a proposed product matches.
1. If no product available within specified category matches and complies with other specified requirements, comply with requirements in Division 01 Section "Substitution Procedures" for proposal of product.
- D. Visual Selection Specification: Where Specifications include the phrase "as selected by Architect from manufacturer's full range" or similar phrase, select a product that complies with requirements. Architect will select color, gloss, pattern, density, or texture from manufacturer's product line that includes both standard and premium items.

2.2 COMPARABLE PRODUCTS

- A. Conditions for Consideration: Architect will consider Contractor's request for comparable product when the following conditions are satisfied. If the following conditions are not satisfied, Architect may return requests without action, except to record noncompliance with these requirements:
1. Evidence that the proposed product does not require revisions to the Contract Documents, that it is consistent with the Contract Documents and will produce the indicated results, and that it is compatible with other portions of the Work.
 2. Detailed comparison of significant qualities of proposed product with those named in the Specifications. Significant qualities include attributes such as performance, weight, size, durability, visual effect, and specific features and requirements indicated.
 3. Evidence that proposed product provides specified warranty.
 4. List of similar installations for completed projects with project names and addresses and names and addresses of architects and owners, if requested.
 5. Samples, if requested.

2.3 SUBSTITUTIONS

- A. Substitutions for Cause: Submit requests for substitution immediately on discovery of need for change, but not later than 15 days prior to time required for preparation and review of related submittals.
1. Conditions: Architect will consider Contractor's request for substitution when the following conditions are satisfied. If the following conditions are not satisfied, Architect will return requests without action, except to record noncompliance with these requirements:
 - a. Requested substitution is consistent with the Contract Documents and will produce indicated results.
 - b. Requested substitution provides sustainable design characteristics that specified product provided.
 - c. Substitution request is fully documented and properly submitted.
 - d. Requested substitution will not adversely affect Contractor's construction schedule.
 - e. Requested substitution has received necessary approvals of authorities having jurisdiction.
 - f. Requested substitution is compatible with other portions of the Work.
 - g. Requested substitution has been coordinated with other portions of the Work.
 - h. Requested substitution provides specified warranty.

- i. If requested substitution involves more than one contractor, requested substitution has been coordinated with other portions of the Work, is uniform and consistent, is compatible with other products, and is acceptable to all contractors involved.
- B. Substitutions for Convenience: Architect will consider requests for substitution if received within 30 days after the Notice of Award. Requests received after that time may be considered or rejected at discretion of Architect.
1. Conditions: Architect will consider Contractor's request for substitution when the following conditions are satisfied. If the following conditions are not satisfied, Architect will return requests without action, except to record noncompliance with these requirements:
- a. Requested substitution offers Owner a substantial advantage in cost, time, energy conservation, or other considerations, after deducting additional responsibilities Owner must assume. Owner's additional responsibilities may include compensation to Architect for redesign and evaluation services, increased cost of other construction by Owner, and similar considerations.
 - b. Requested substitution does not require extensive revisions to the Contract Documents.
 - c. Requested substitution is consistent with the Contract Documents and will produce indicated results.
 - d. Requested substitution provides sustainable design characteristics that specified product provided.
 - e. Substitution request is fully documented and properly submitted.
 - f. Requested substitution will not adversely affect Contractor's construction schedule.
 - g. Requested substitution has received necessary approvals of authorities having jurisdiction.
 - h. Requested substitution is compatible with other portions of the Work.
 - i. Requested substitution has been coordinated with other portions of the Work.
 - j. Requested substitution provides specified warranty.
 - k. If requested substitution involves more than one contractor, requested substitution has been coordinated with other portions of the Work, is uniform and consistent, is compatible with other products, and is acceptable to all contractors involved.

2.4 MANUFACTURER'S INSTRUCTIONS

- A. When contract documents require installation of work to comply with manufacturer's printed instructions, obtain and distribute copies of such instructions to parties involved in the installation, including two copies to the Owner's Representative. Maintain one copy of the instructions at the job site until project completion.
- B. Should project conditions, drawings or specification requirements conflict with manufacturer's instructions the Contractor shall advise the Architect for further instructions, prior to commencement of the work.
- C. Perform all work in accordance with manufacturer's instructions. Do not omit any preparatory step or installation procedure. If there are any conflicts with the contract documents notify the Architect prior to proceeding with the work.

PART 3 - EXECUTION (Not Used)

END OF SECTION 01 60 00

SECTION 01 73 00 - EXECUTION**PART 1 - GENERAL****1.1 RELATED DOCUMENTS**

- A. Drawings and general provisions of the Contract, including General and Supplementary Conditions and other Division 01 Specification Sections, apply to this Section.

1.2 SUMMARY

- A. Section includes general administrative and procedural requirements governing execution of the Work including, but not limited to, the following:

1. Construction layout.
2. Field engineering and surveying.
3. Installation of the Work.
4. Cutting and patching.
5. Coordination of Owner-installed products.
6. Progress cleaning.
7. Starting and adjusting.
8. Protection of installed construction.
9. Correction of the Work.

- B. Related Requirements:

1. Division 01 Section "Summary" for limits on use of Project site.
2. Division 01 Section "Submittal Procedures" for submitting surveys.
3. Division 01 Section "Closeout Procedures" for submitting final property survey with Project Record Documents, recording of Owner-accepted deviations from indicated lines and levels, and final cleaning.

1.3 DEFINITIONS

- A. Cutting: Removal of in-place construction necessary to permit installation or performance of other work.
- B. Patching: Fitting and repair work required to restore construction to original conditions after installation of other work.

1.4 INFORMATIONAL SUBMITTALS

- A. Qualification Data: For land surveyor and professional engineer.
- B. Certificates: Submit certificate signed by land surveyor or professional engineer certifying that location and elevation of improvements comply with requirements.
- C. Landfill Receipts: Submit copy of receipts issued by a landfill facility, licensed to accept hazardous materials, for hazardous waste disposal.
- D. Certified Surveys: Submit two copies signed by land surveyor.

- E. Final Property Survey: Submit 5 copies showing the Work performed and record survey data.

1.5 QUALITY ASSURANCE

- A. Cutting and Patching: Comply with requirements for and limitations on cutting and patching of construction elements.
 - 1. Structural Elements: When cutting and patching structural elements, notify Architect of locations and details of cutting and await directions from Architect before proceeding. Shore, brace, and support structural elements during cutting and patching. Do not cut and patch structural elements in a manner that could change their load-carrying capacity or increase deflection
 - 2. Operational Elements: Do not cut and patch operating elements and related components in a manner that results in reducing their capacity to perform as intended or that results in increased maintenance or decreased operational life or safety.
 - 3. Other Construction Elements: Do not cut and patch other construction elements or components in a manner that could change their load-carrying capacity, that results in reducing their capacity to perform as intended, or that results in increased maintenance or decreased operational life or safety.
 - 4. Visual Elements: Do not cut and patch construction in a manner that results in visual evidence of cutting and patching. Do not cut and patch exposed construction in a manner that would, in Architect's opinion, reduce the building's aesthetic qualities. Remove and replace construction that has been cut and patched in a visually unsatisfactory manner.
- B. Cutting and Patching Conference: Before proceeding, meet at Project site with parties involved in cutting and patching, including mechanical and electrical trades. Review areas of potential interference and conflict. Coordinate procedures and resolve potential conflicts before proceeding.
- C. Manufacturer's Installation Instructions: Obtain and maintain on-site manufacturer's written recommendations and instructions for installation of products and equipment.

PART 2 - PRODUCTS

2.1 MATERIALS

- A. In-Place Materials: Use materials for patching identical to in-place materials. For exposed surfaces, use materials that visually match in-place adjacent surfaces to the fullest extent possible.
 - 1. If identical materials are unavailable or cannot be used, use materials that, when installed, will provide a match acceptable to Architect for the visual and functional performance of in-place materials.

PART 3 - EXECUTION**3.1 EXAMINATION**

- A. Existing Conditions: The existence and location of underground and other utilities and construction indicated as existing are not guaranteed. Before beginning sitework, investigate and verify the existence and location of underground utilities, mechanical and electrical systems, and other construction affecting the Work.
1. Before construction, verify the location and invert elevation at points of connection of sanitary sewer, storm sewer, and water-service piping; underground electrical services, and other utilities.
 2. Furnish location data for work related to Project that must be performed by public utilities serving Project site.
- B. Examination and Acceptance of Conditions: Before proceeding with each component of the Work, examine substrates, areas, and conditions, with Installer or Applicator present where indicated, for compliance with requirements for installation tolerances and other conditions affecting performance. Record observations.
1. Examine roughing-in for mechanical and electrical systems to verify actual locations of connections before equipment and fixture installation.
 2. Examine walls, floors, and roofs for suitable conditions where products and systems are to be installed.
 3. Verify compatibility with and suitability of substrates, including compatibility with existing finishes or primers.
- C. Written Report: Where a written report listing conditions detrimental to performance of the Work is required by other Sections, include the following:
1. Description of the Work.
 2. List of detrimental conditions, including substrates.
 3. List of unacceptable installation tolerances.
 4. Recommended corrections.
- D. Proceed with installation only after unsatisfactory conditions have been corrected. Proceeding with the Work indicates acceptance of surfaces and conditions.

3.2 PREPARATION

- A. Existing Utility Information: Furnish information to [local utility that is necessary to adjust, move, or relocate existing utility structures, utility poles, lines, services, or other utility appurtenances located in or affected by construction. Coordinate with authorities having jurisdiction.
- B. Field Measurements: Take field measurements as required to fit the Work properly. Recheck measurements before installing each product. Where portions of the Work are indicated to fit to other construction, verify dimensions of other construction by field measurements before fabrication. Coordinate fabrication schedule with construction progress to avoid delaying the Work.
- C. Space Requirements:
1. Verify space requirements and dimensions of items shown diagrammatically on Drawings.

2. Verify required finished ceiling height requirements prior to fabrication of HVAC and fire protection system piping or ductwork.

D. Review of Contract Documents and Field Conditions: Immediately on discovery of the need for clarification of the Contract Documents caused by differing field conditions outside the control of Contractor, submit a request for information to Architect according to requirements in Division 01 Section "Project Management and Coordination."

3.3 INSTALLATION

A. General: Locate the Work and components of the Work accurately, in correct alignment and elevation, as indicated.

1. Make vertical work plumb and make horizontal work level.
2. Where space is limited, install components to maximize space available for maintenance and ease of removal for replacement.
3. Conceal pipes, ducts, and wiring in finished areas unless otherwise indicated.
4. Maintain minimum headroom clearance as indicated or of 96 inches (2440 mm) in occupied spaces and 90 inches (2300 mm) in unoccupied spaces, whichever is greater.

B. Comply with manufacturer's written instructions and recommendations for installing products in applications indicated.

C. Install products at the time and under conditions that will ensure the best possible results. Maintain conditions required for product performance until Substantial Completion.

D. Conduct construction operations so no part of the Work is subjected to damaging operations or loading in excess of that expected during normal conditions of occupancy.

E. Sequence the Work and allow adequate clearances to accommodate movement of construction items on site and placement in permanent locations.

F. Tools and Equipment: Do not use tools or equipment that produce harmful noise levels.

G. Templates: Obtain and distribute to the parties involved templates for work specified to be factory prepared and field installed. Check Shop Drawings of other work to confirm that adequate provisions are made for locating and installing products to comply with indicated requirements.

H. Attachment: Provide blocking and attachment plates and anchors and fasteners of adequate size and number to securely anchor each component in place, accurately located and aligned with other portions of the Work. Where size and type of attachments are not indicated, verify size and type required for load conditions.

1. Mounting Heights: Where mounting heights are not indicated, mount components at heights directed by Architect.
2. Allow for building movement, including thermal expansion and contraction.
3. Coordinate installation of anchorages. Furnish setting drawings, templates, and directions for installing anchorages, including sleeves, concrete inserts, anchor bolts, and items with integral anchors, that are to be embedded in concrete or masonry. Deliver such items to Project site in time for installation.

I. Joints: Make joints of uniform width. Where joint locations in exposed work are not indicated, arrange joints for the best visual effect. Fit exposed connections together to form hairline joints.

- J. Hazardous Materials: Use products, cleaners, and installation materials that are not considered hazardous.

3.4 CUTTING AND PATCHING

- A. Cutting and Patching, General: Employ skilled workers to perform cutting and patching. Proceed with cutting and patching at the earliest feasible time, and complete without delay.
 - 1. Cut in-place construction to provide for installation of other components or performance of other construction, and subsequently patch as required to restore surfaces to their original condition.
- B. Temporary Support: Provide temporary support of work to be cut.
- C. Protection: Protect in-place construction during cutting and patching to prevent damage. Provide protection from adverse weather conditions for portions of Project that might be exposed during cutting and patching operations.
- D. Existing Utility Services and Mechanical/Electrical Systems: Where existing services/systems are required to be removed, relocated, or abandoned, bypass such services/systems before cutting to minimize interruption to occupied areas.
- E. Cutting: Cut in-place construction by sawing, drilling, breaking, chipping, grinding, and similar operations, including excavation, using methods least likely to damage elements retained or adjoining construction. If possible, review proposed procedures with original Installer; comply with original Installer's written recommendations.
 - 1. In general, use hand or small power tools designed for sawing and grinding, not hammering and chopping. Cut holes and slots neatly to minimum size required, and with minimum disturbance of adjacent surfaces. Temporarily cover openings when not in use.
 - 2. Finished Surfaces: Cut or drill from the exposed or finished side into concealed surfaces.
 - 3. Concrete and Masonry: Cut using a cutting machine, such as an abrasive saw or a diamond-core drill.
 - 4. Excavating and Backfilling: Comply with requirements in applicable Division 31 Sections where required by cutting and patching operations.
 - 5. Proceed with patching after construction operations requiring cutting are complete.
- F. Patching: Patch construction by filling, repairing, refinishing, closing up, and similar operations following performance of other work. Patch with durable seams that are as invisible as practicable. Provide materials and comply with installation requirements specified in other Sections, where applicable.
 - 1. Inspection: Where feasible, test and inspect patched areas after completion to demonstrate physical integrity of installation.
 - 2. Exposed Finishes: Restore exposed finishes of patched areas and extend finish restoration into retained adjoining construction in a manner that will minimize evidence of patching and refinishing.
 - a. Clean piping, conduit, and similar features before applying paint or other finishing materials.
 - b. Restore damaged pipe covering to its original condition.
 - 3. Floors and Walls: Where walls or partitions that are removed extend one finished area into another, patch and repair floor and wall surfaces in the new space.

Provide an even surface of uniform finish, color, texture, and appearance. Remove in-place floor and wall coverings and replace with new materials, if necessary, to achieve uniform color and appearance.

- a. Where patching occurs in a painted surface, prepare substrate and apply primer and intermediate paint coats appropriate for substrate over the patch, and apply final paint coat over entire unbroken surface containing the patch. Provide additional coats until patch blends with adjacent surfaces.
 4. Ceilings: Patch, repair, or rehang in-place ceilings as necessary to provide an even-plane surface of uniform appearance.
 5. Exterior Building Enclosure: Patch components in a manner that restores enclosure to a weathertight condition and ensures thermal and moisture integrity of building enclosure.
- G. Cleaning: Clean areas and spaces where cutting and patching are performed. Remove paint, mortar, oils, putty, and similar materials from adjacent finished surfaces.

3.5 PROGRESS CLEANING

- A. General: Clean Project site and work areas daily, including common areas. Enforce requirements strictly. Dispose of materials lawfully.
1. Comply with requirements in NFPA 241 for removal of combustible waste materials and debris.
 2. Do not hold waste materials more than seven days during normal weather or three days if the temperature is expected to rise above 80 deg F (27 deg C).
 3. Containerize hazardous and unsanitary waste materials separately from other waste. Mark containers appropriately and dispose of legally, according to regulations.
 - a. Use containers intended for holding waste materials of type to be stored.
- B. Site: Maintain Project site free of waste materials and debris.
- C. Work Areas: Clean areas where work is in progress to the level of cleanliness necessary for proper execution of the Work.
1. Remove liquid spills promptly.
 2. Where dust would impair proper execution of the Work, broom-clean or vacuum the entire work area, as appropriate.
- D. Installed Work: Keep installed work clean. Clean installed surfaces according to written instructions of manufacturer or fabricator of product installed, using only cleaning materials specifically recommended. If specific cleaning materials are not recommended, use cleaning materials that are not hazardous to health or property and that will not damage exposed surfaces.
- E. Concealed Spaces: Remove debris from concealed spaces before enclosing the space.
- F. Exposed Surfaces in Finished Areas: Clean exposed surfaces and protect as necessary to ensure freedom from damage and deterioration at time of Substantial Completion.
- G. Waste Disposal: Do not bury or burn waste materials on-site. Do not wash waste materials down sewers or into waterways. Comply with waste disposal requirements in Division 01 Section "Construction Waste Management and Disposal."

- H. During handling and installation, clean and protect construction in progress and adjoining materials already in place. Apply protective covering where required to ensure protection from damage or deterioration at Substantial Completion.
- I. Clean and provide maintenance on completed construction as frequently as necessary through the remainder of the construction period. Adjust and lubricate operable components to ensure operability without damaging effects.
- J. Limiting Exposures: Supervise construction operations to assure that no part of the construction completed or in progress, is subject to harmful, dangerous, damaging, or otherwise deleterious exposure during the construction period.

3.6 STARTING AND ADJUSTING

- A. Coordinate startup and adjusting of equipment and operating components with requirements in Division 01 Sections.
- B. Start equipment and operating components to confirm proper operation. Remove malfunctioning units, replace with new units, and retest.
- C. Adjust equipment for proper operation. Adjust operating components for proper operation without binding.
- D. Test each piece of equipment to verify proper operation. Test and adjust controls and safeties. Replace damaged and malfunctioning controls and equipment.
- E. Manufacturer's Field Service: Comply with qualification requirements in Division 01 Section "Quality Requirements."

3.7 PROTECTION OF INSTALLED CONSTRUCTION

- A. Provide final protection and maintain conditions that ensure installed Work is without damage or deterioration at time of Substantial Completion.
- B. Comply with manufacturer's written instructions for temperature and relative humidity.

END OF SECTION 01 73 00

SECTION 01 74 19 - CONSTRUCTION WASTE MANAGEMENT AND DISPOSAL**PART 1 - GENERAL****1.1 RELATED DOCUMENTS**

- A. Drawings and general provisions of the Contract, including General and Supplementary Conditions and other Division 01 Specification Sections, apply to this Section.

1.2 SUMMARY

- A. Section includes administrative and procedural requirements for the following:
 - 1. Salvaging nonhazardous demolition and construction waste.
 - 2. Recycling nonhazardous demolition and construction waste.
 - 3. Disposing of nonhazardous demolition and construction waste.

1.3 DEFINITIONS

- A. Construction Waste: Building and site improvement materials and other solid waste resulting from construction, remodeling, renovation, or repair operations. Construction waste includes packaging.
- B. Demolition Waste: Building and site improvement materials resulting from site preparation demolition or selective demolition operations.
- C. Disposal: Removal off-site of demolition and construction waste and subsequent sale, recycling, reuse, or deposit in landfill or incinerator acceptable to authorities having jurisdiction.
- D. Recycle: Recovery of demolition or construction waste for subsequent processing in preparation for reuse.
- E. Salvage: Recovery of demolition or construction waste and subsequent sale or reuse in another facility.

1.4 PERFORMANCE REQUIREMENTS

- A. General: Achieve end-of-Project rates for salvage/recycling of 50 percent by weight of total non-hazardous solid waste generated by the Work. Practice efficient waste management in the use of materials in the course of the Work. Use all reasonable means to divert construction and demolition waste from landfills and incinerators. Facilitate recycling and salvage of materials, including the following:
 - 1. Construction Waste:
 - a. Plaster.
 - b. Packaging: Regardless of salvage/recycle goal indicated in "General" Paragraph above, salvage or recycle 100 percent of the following uncontaminated packaging materials:

- 1) Paper.
- 2) Cardboard.
- 3) Boxes.
- 4) Plastic sheet and film.
- 5) Polystyrene packaging.
- 6) Wood crates.
- 7) Plastic pails.

1.5 ACTION SUBMITTALS

- A. Waste Management Plan: Submit plan within 7 days of date established for the Notice of Award.

1.6 INFORMATIONAL SUBMITTALS

- A. Waste Reduction Progress Reports: Concurrent with each Application for Payment, submit report. Use Form CWM-7 for construction waste and Form CWM-8 for demolition waste. Include the following information:
 1. Material category.
 2. Generation point of waste.
 3. Total quantity of waste in tons (tonnes).
 4. Quantity of waste salvaged, both estimated and actual in tons (tonnes).
 5. Quantity of waste recycled, both estimated and actual in tons (tonnes).
 6. Total quantity of waste recovered (salvaged plus recycled) in tons (tonnes).
 7. Total quantity of waste recovered (salvaged plus recycled) as a percentage of total waste.
- B. Waste Reduction Calculations: Before request for Substantial Completion, submit calculated end-of-Project rates for salvage, recycling, and disposal as a percentage of total waste generated by the Work.
- C. Records of Donations: Indicate receipt and acceptance of salvageable waste donated to individuals and organizations. Indicate whether organization is tax exempt.
- D. Records of Sales: Indicate receipt and acceptance of salvageable waste sold to individuals and organizations. Indicate whether organization is tax exempt.
- E. Recycling and Processing Facility Records: Indicate receipt and acceptance of recyclable waste by recycling and processing facilities licensed to accept them. Include manifests, weight tickets, receipts, and invoices.
- F. Landfill and Incinerator Disposal Records: Indicate receipt and acceptance of waste by landfills and incinerator facilities licensed to accept them. Include manifests, weight tickets, receipts, and invoices.

1.7 QUALITY ASSURANCE

- A. Regulatory Requirements: Comply with hauling and disposal regulations of authorities having jurisdiction.
- B. Waste Management Conference: Conduct conference at Project site to comply with requirements in Division 01 Section "Project Management and Coordination." Review

methods and procedures related to waste management including, but not limited to, the following:

1. Review and discuss waste.
2. Review requirements for documenting quantities of each type of waste and its disposition.
3. Review and finalize procedures for materials separation and verify availability of containers and bins needed to avoid delays.
4. Review procedures for periodic waste collection and transportation to recycling and disposal facilities.
5. Review waste management requirements for each trade.

1.8 WASTE MANAGEMENT PLAN

- A. General: Develop a waste management plan according to ASTM E 1609 and requirements in this Section. Plan shall consist of waste identification, waste reduction work plan, and cost/revenue analysis. Distinguish between demolition and construction waste. Indicate quantities by weight or volume, but use same units of measure throughout waste management plan.
- B. Waste Identification: Indicate anticipated types and quantities of site-preparation and construction waste generated by the Work. Use Form CWM-1 for construction waste and Form CWM-2 for site preparation waste. Include estimated quantities and assumptions for estimates.
- C. Waste Reduction Work Plan: List each type of waste and whether it will be salvaged, recycled, or disposed of in landfill or incinerator. Use Form CWM-3 for construction waste and Form CWM-4 for site preparation waste. Include points of waste generation, total quantity of each type of waste, quantity for each means of recovery, and handling and transportation procedures.
1. Salvaged Materials for Sale: For materials that will be sold to individuals and organizations, include list of their names, addresses, and telephone numbers.
 2. Salvaged Materials for Donation: For materials that will be donated to individuals and organizations, include list of their names, addresses, and telephone numbers.
 3. Recycled Materials: Include list of local receivers and processors and type of recycled materials each will accept. Include names, addresses, and telephone numbers.
 4. Disposed Materials: Indicate how and where materials will be disposed of. Include name, address, and telephone number of each landfill and incinerator facility.
 5. Handling and Transportation Procedures: Include method that will be used for separating recyclable waste including sizes of containers, container labeling, and designated location where materials separation will be performed.
- D. Cost/Revenue Analysis: Indicate total cost of waste disposal as if there was no waste management plan and net additional cost or net savings resulting from implementing waste management plan. Use Form CWM-5 for construction waste and Form CWM-6 for site preparation waste. Include the following:
1. Total quantity of waste.
 2. Estimated cost of disposal (cost per unit). Include hauling and tipping fees and cost of collection containers for each type of waste.
 3. Total cost of disposal (with no waste management).
 4. Revenue from salvaged materials.
 5. Revenue from recycled materials.
 6. Savings in hauling and tipping fees by donating materials.

7. Savings in hauling and tipping fees that are avoided.
8. Handling and transportation costs. Include cost of collection containers for each type of waste.
9. Net additional cost or net savings from waste management plan.

PART 2 - PRODUCTS (Not Used)

PART 3 - EXECUTION

3.1 PLAN IMPLEMENTATION

- A. General: Implement approved waste management plan. Provide handling, containers, storage, signage, transportation, and other items as required to implement waste management plan during the entire duration of the Contract.
 1. Comply with operation, termination, and removal requirements in Division 01 Section "Temporary Facilities and Controls."
- B. Waste Management Coordinator: This can be the contractor's project manager, superintendent or other qualified individual acceptable to the architect. Waste management coordinator shall be responsible for implementing, monitoring, and reporting status of waste management work plan.
- C. Training: Train workers, subcontractors, and suppliers on proper waste management procedures, as appropriate for the Work.
 1. Distribute waste management plan to everyone concerned within three days of submittal return.
 2. Distribute waste management plan to entities when they first begin work on-site. Review plan procedures and locations established for salvage, recycling, and disposal.
- D. Site Access and Temporary Controls: Conduct waste management operations to ensure minimum interference with roads, streets, walks, walkways, and other adjacent occupied and used facilities.
 1. Designate and label specific areas on Project site necessary for separating materials that are to be salvaged, recycled, reused, donated, and sold.
 2. Comply with Division 01 Section "Temporary Facilities and Controls" for controlling dust and dirt, environmental protection, and noise control.

3.2 SALVAGING DEMOLITION WASTE

- A. Salvaged Items for Sale and Donation: Not permitted on Project site.

3.3 RECYCLING WASTE, GENERAL

- A. General: Recycle paper and beverage containers used by on-site workers.
- B. Recycling Incentives: Revenues, savings, rebates, tax credits, and other incentives received for recycling waste materials shall accrue to Contractor.

- C. Preparation of Waste: Prepare and maintain recyclable waste materials according to recycling or reuse facility requirements. Maintain materials free of dirt, adhesives, solvents, petroleum contamination, and other substances deleterious to the recycling process.
- D. Procedures: Separate recyclable waste from other waste materials, trash, and debris. Separate recyclable waste by type at Project site to the maximum extent practical according to approved construction waste management plan.
 - 1. Contractor's Option: As this construction site is very limited in area the use of a commingled collection system with off site separation is acceptable.
 - 2. Provide appropriately marked containers or bins for controlling recyclable waste until removed from Project site. Include list of acceptable and unacceptable materials at each container and bin.
 - a. Inspect containers and bins for contamination and remove contaminated materials if found.
 - 3. Stockpile processed materials on-site without intermixing with other materials. Place, grade, and shape stockpiles to drain surface water. Cover to prevent windblown dust.
 - 4. Stockpile materials away from construction area. Do not store within drip line of remaining trees.
 - 5. Store components off the ground and protect from the weather.
 - 6. Remove recyclable waste from Owner's property and transport to recycling receiver or processor.

3.4 RECYCLING CONSTRUCTION WASTE

A. Packaging:

- 1. Cardboard and Boxes: Break down packaging into flat sheets. Bundle and store in a dry location.
- 2. Polystyrene Packaging: Separate and bag materials.
- 3. Pallets: As much as possible, require deliveries using pallets to remove pallets from Project site. For pallets that remain on-site, break down pallets into component wood pieces and comply with requirements for recycling wood.
- 4. Crates: Break down crates into component wood pieces and comply with requirements for recycling wood.

3.5 DISPOSAL OF WASTE

- A. General: Except for items or materials to be salvaged, recycled, or otherwise reused, remove waste materials from Project site and legally dispose of them in a landfill or incinerator acceptable to authorities having jurisdiction.
 - 1. Except as otherwise specified, do not allow waste materials that are to be disposed of accumulate on-site.
 - 2. Remove and transport debris in a manner that will prevent spillage on adjacent surfaces and areas.
- B. Burning: Do not burn waste materials.
- C. Disposal: Remove waste materials from Owner's property and legally dispose of them.

END OF SECTION 01 74 19

SECTION 01 77 00 - CLOSEOUT PROCEDURES**PART 1 - GENERAL****1.1 RELATED DOCUMENTS**

- A. Drawings and general provisions of the Contract, including General and Supplementary Conditions and other Division 01 Specification Sections, apply to this Section.

1.2 SUMMARY

- A. Section includes administrative and procedural requirements for contract closeout, including, but not limited to, the following:
 - 1. Substantial Completion procedures.
 - 2. Final completion procedures.
 - 3. Warranties.
 - 4. Final cleaning.
 - 5. Repair of the Work.
- B. Related Requirements:
 - 1. Division 01 Section "Execution" for progress cleaning of Project site.
 - 2. Division 01 Section "Operation and Maintenance Data" for operation and maintenance manual requirements.
 - 3. Division 01 Section "Project Record Documents" for submitting record Drawings, record Specifications, and record Product Data.
 - 4. Division 01 Section "Demonstration and Training" for requirements for instructing Owner's personnel.
 - 5. Divisions 02 through 33 Sections for specific closeout and special cleaning requirements for the Work in those Sections.

1.3 ACTION SUBMITTALS

- A. Product Data: For cleaning agents.
- B. Contractor's List of Incomplete Items: Initial submittal at Substantial Completion.
- C. Certified List of Incomplete Items: Final submittal at Final Completion.

1.4 CLOSEOUT SUBMITTALS

- A. Certificates of Release: From authorities having jurisdiction.
- B. Certificate of Insurance: For continuing coverage.
- C. Field Report: For pest control inspection.
- D. Certificate Of Occupancy from the authorities having jurisdiction.

1.5 MAINTENANCE MATERIAL SUBMITTALS

- A. Schedule of Maintenance Material Items: For maintenance material submittal items specified in other Sections.

1.6 SUBSTANTIAL COMPLETION PROCEDURES

- A. Contractor's List of Incomplete Items: Prepare and submit a list of items to be completed and corrected (Contractor's punch list), indicating the value of each item on the list and reasons why the Work is incomplete.

- B. Submittals Prior to Substantial Completion: Complete the following a minimum of 21 days prior to requesting inspection for determining date of Substantial Completion. List items below that are incomplete at time of request.

1. Certificates of Release: Obtain and submit releases from authorities having jurisdiction permitting Owner unrestricted use of the Work and access to services and utilities. Include occupancy permits, operating certificates, and similar releases.
2. Submit closeout submittals specified in other Division 01 Sections, including project record documents, operation and maintenance manuals, damage or settlement surveys, property surveys, and similar final record information.
3. Submit closeout submittals specified in individual Divisions 02 through 33 Sections, including specific warranties, workmanship bonds, maintenance service agreements, final certifications, and similar documents.
4. Submit maintenance material submittals specified in individual Divisions 02 through 33 Sections, including tools, spare parts, extra materials, and similar items, and deliver to location designated by Architect. Label with manufacturer's name and model number where applicable.
 - a. Schedule of Maintenance Material Items: Prepare and submit schedule of maintenance material submittal items, including name and quantity of each item and name and number of related Specification Section. Obtain Architect's signature for receipt of submittals.
5. Submit test/adjust/balance records.
6. Submit changeover information related to Owner's occupancy, use, operation, and maintenance.

- C. Procedures Prior to Substantial Completion: Complete the following a minimum of 21 days prior to requesting inspection for determining date of Substantial Completion. List items below that are incomplete at time of request.

1. Advise Owner of pending insurance changeover requirements.
2. Make final changeover of permanent locks and deliver keys to Owner. Advise Owner's personnel of changeover in security provisions.
3. Complete startup and testing of systems and equipment.
4. Perform preventive maintenance on equipment used prior to Substantial Completion.
5. Instruct Owner's personnel in operation, adjustment, and maintenance of products, equipment, and systems.
6. Advise Owner of changeover in heat and other utilities.
7. Participate with Owner in conducting inspection and walkthrough with local emergency responders.
8. Terminate and remove temporary facilities from Project site, along with mockups, construction tools, and similar elements.
9. Complete final cleaning requirements, including touchup painting.

10. Touch up and otherwise repair and restore marred exposed finishes to eliminate visual defects.
- D. Inspection: Submit a written request for inspection to determine Substantial Completion a minimum of 21 days prior to date the work will be completed and ready for final inspection and tests. On receipt of request, Architect will either proceed with inspection or notify Contractor of unfulfilled requirements. Architect will prepare the Certificate of Substantial Completion after inspection or will notify Contractor of items, either on Contractor's list or additional items identified by Architect, that must be completed or corrected before certificate will be issued.
1. Reinspection: Request reinspection when the Work identified in previous inspections as incomplete is completed or corrected.
 2. Results of completed inspection will form the basis of requirements for final completion.

1.7 FINAL COMPLETION PROCEDURES

- A. Submittals Prior to Final Completion: Before requesting final inspection for determining final completion, complete the following:
1. Submit a final Application for Payment according to Division 01 Section "Payment Procedures."
 2. Certified List of Incomplete Items: Submit certified copy of Architect's Substantial Completion inspection list of items to be completed or corrected (punch list), endorsed and dated by Architect. Certified copy of the list shall state that each item has been completed or otherwise resolved for acceptance.
 3. Certificate of Insurance: Submit evidence of final, continuing insurance coverage complying with insurance requirements.
 4. Submit pest-control final inspection report.
- B. Inspection: Submit a written request for final inspection to determine acceptance a minimum of 14 days prior to date the work will be completed and ready for final inspection and tests. On receipt of request, Architect will either proceed with inspection or notify Contractor of unfulfilled requirements. Architect will prepare a final Certificate for Payment after inspection or will notify Contractor of construction that must be completed or corrected before certificate will be issued.
1. Reinspection: Request reinspection when the Work identified in previous inspections as incomplete is completed or corrected.

1.8 LIST OF INCOMPLETE ITEMS (PUNCH LIST)

- A. Organization of List: Include name and identification of each space and area affected by construction operations for incomplete items and items needing correction including, if necessary, areas disturbed by Contractor that are outside the limits of construction. Use CSI Form 14.1A.
1. Organize list of spaces in sequential order, starting with exterior areas first and proceeding from lowest floor to highest floor.
 2. Organize items applying to each space by major element, including categories for ceiling, individual walls, floors, equipment, and building systems.
 3. Include the following information at the top of each page:
 - a. Project name.

- b. Date.
 - c. Name of Architect.
 - d. Name of Contractor.
 - e. Page number.
4. Submit list of incomplete items in the following format:
- a. MS Excel electronic file. Architect will return annotated file.
 - b. PDF electronic file. This file is for record purposes.

1.9 SUBMITTAL OF PROJECT WARRANTIES

- A. Time of Submittal: Submit written warranties on request of Architect for designated portions of the Work where commencement of warranties other than date of Substantial Completion is indicated, or when delay in submittal of warranties might limit Owner's rights under warranty.
- B. Organize warranty documents into an orderly sequence based on the table of contents of Project Manual.
1. Bind warranties and bonds in heavy-duty, three-ring, vinyl-covered, loose-leaf binders, thickness as necessary to accommodate contents, and sized to receive 8-1/2-by-11-inch (215-by-280-mm) paper.
 2. Provide heavy paper dividers with plastic-covered tabs for each separate warranty. Mark tab to identify the product or installation. Provide a typed description of the product or installation, including the name of the product and the name, address, and telephone number of Installer.
 3. Identify each binder on the front and spine with the typed or printed title "WARRANTIES," Project name, and name of Contractor.
 4. Warranty Electronic File: Scan warranties and bonds and assemble complete warranty and bond submittal package into a single indexed electronic PDF file with links enabling navigation to each item. Provide bookmarked table of contents at beginning of document.
- C. Provide additional copies of each warranty to include in operation and maintenance manuals.

1.10 RE-INSPECTION FEES

- A. Should Architect perform re-inspections due to failure of the work to comply with the claims or status of completion made by the Contractor:
1. Owner will compensate the Architect for such additional services.

PART 2 - PRODUCTS

2.1 MATERIALS

- A. Cleaning Agents: Use cleaning materials and agents recommended by manufacturer or fabricator of the surface to be cleaned. Do not use cleaning agents that are potentially hazardous to health or property or that might damage finished surfaces.

1. Use cleaning products that comply with Green Seal's GS-37, or if GS-37 is not applicable, use products that comply with the California Code of Regulations maximum allowable VOC levels.

PART 3 - EXECUTION

3.1 FINAL CLEANING

- A. General: Perform final cleaning. Conduct cleaning and waste-removal operations to comply with local laws and ordinances and Federal and local environmental and antipollution regulations.
- B. Cleaning: Employ experienced workers or professional cleaners for final cleaning. Clean each surface or unit to condition expected in an average commercial building cleaning and maintenance program. Comply with manufacturer's written instructions.
 1. Complete the following cleaning operations before requesting inspection for certification of Substantial Completion for entire Project or for a designated portion of Project:
 - a. Remove tools, construction equipment, machinery, and surplus material from Project site.
 - b. Clean exposed interior hard-surfaced finishes to a dirt-free condition, free of stains, films, and similar foreign substances.
 - c. Vacuum carpet and similar soft surfaces, removing debris and excess nap; clean according to manufacturer's recommendations if visible soil or stains remain.
 - d. Clean transparent materials, including mirrors and glass in doors and windows. Remove glazing compounds and other noticeable, vision-obscuring materials. Polish mirrors and glass, taking care not to scratch surfaces.
 - e. Wipe surfaces of mechanical and electrical equipment, elevator equipment, and similar equipment. Remove excess lubrication, paint and mortar droppings, and other foreign substances.
 - f. Clean light fixtures, lamps, globes, and reflectors to function with full efficiency.
 - g. Leave Project clean and ready for occupancy.
- C. Construction Waste Disposal: Comply with waste disposal requirements in Division 01 Section "Construction Waste Management and Disposal."

3.2 REPAIR OF THE WORK

- A. Complete repair and restoration operations before requesting inspection for determination of Substantial Completion.
- B. Repair or remove and replace defective construction. Repairing includes replacing defective parts, refinishing damaged surfaces, touching up with matching materials, and properly adjusting operating equipment. Where damaged or worn items cannot be repaired or restored, provide replacements. Remove and replace operating components that cannot be repaired. Restore damaged construction and permanent facilities used during construction to specified condition.
 1. Remove and replace chipped, scratched, and broken glass, reflective surfaces, and other damaged transparent materials.

2. Touch up and otherwise repair and restore marred or exposed finishes and surfaces. Replace finishes and surfaces that that already show evidence of repair or restoration.
 - a. Do not paint over "UL" and other required labels and identification, including mechanical and electrical nameplates. Remove paint applied to required labels and identification.
3. Replace parts subject to operating conditions during construction that may impede operation or reduce longevity.
4. Replace burned-out bulbs, bulbs noticeably dimmed by hours of use, and defective and noisy starters in fluorescent and mercury vapor fixtures to comply with requirements for new fixtures.

END OF SECTION 01 77 00

SECTION 01 78 39 - PROJECT RECORD DOCUMENTS**PART 1 - GENERAL****1.1 SUMMARY**

- A. Section includes administrative and procedural requirements for project record documents, including the following:
 - 1. Record Drawings.
 - 2. Record Specifications.
 - 3. Record Product Data.
- B. Related Requirements:
 - 1. Division 01 Section "Operation and Maintenance Data" for operation and maintenance manual requirements.
 - 2. Divisions 02 through 26 Sections for specific requirements for project record documents of the Work in those Sections.

1.2 CLOSEOUT SUBMITTALS

- A. Record Drawings: Comply with the following:
 - 1. Number of Copies: Submit copies of record Drawings as follows:
 - a. Initial Submittal:
 - 1) Submit PDF electronic files of scanned record prints and one set of file prints.
 - 2) Architect will indicate whether general scope of changes, additional information recorded, and quality of drafting are acceptable.
 - b. Final Submittal:
 - 1) Submit PDF electronic files of scanned record prints and two set(s) of prints.
 - 2) Print each drawing, whether or not changes and additional information were recorded.
- B. Record Specifications: Submit annotated PDF electronic files of Project's Specifications, including addenda and contract modifications.
- C. Record Product Data: Submit one paper copy of each submittal.

PART 2 - PRODUCTS**2.1 RECORD DRAWINGS**

- A. Record Prints: Maintain one set of marked-up paper copies of the Contract Drawings and Shop Drawings, incorporating new and revised Drawings as modifications are issued.

1. Preparation: Mark record prints to show the actual installation where installation varies from that shown originally. Require individual or entity who obtained record data, whether individual or entity is Installer, subcontractor, or similar entity, to provide information for preparation of corresponding marked-up record prints.
 - a. Give particular attention to information on concealed elements that would be difficult to identify or measure and record later.
 - b. Record data as soon as possible after obtaining it.
 - c. Record and check the markup before enclosing concealed installations.
 2. Mark the Contract Drawings and Shop Drawings completely and accurately. Use personnel proficient at recording graphic information in production of marked-up record prints.
 3. Mark record sets with erasable, red-colored pencil. Use other colors to distinguish between changes for different categories of the Work at same location.
 4. Note Construction Change Directive numbers, alternate numbers, Change Order numbers, and similar identification, where applicable.
- B. Format: Identify and date each record Drawing; include the designation "PROJECT RECORD DRAWING" in a prominent location.
1. Record Prints: Organize record prints and newly prepared record Drawings into manageable sets. Bind each set with durable paper cover sheets. Include identification on cover sheets.
 2. Format: Annotated PDF electronic file with comment function enabled.
 3. Identification: As follows:
 - a. Project name.
 - b. Date.
 - c. Designation "PROJECT RECORD DRAWINGS."
 - d. Name of Architect.
 - e. Name of Contractor.

2.2 RECORD SPECIFICATIONS

- A. Preparation: Mark Specifications to indicate the actual product installation where installation varies from that indicated in Specifications, addenda, and contract modifications.
1. Give particular attention to information on concealed products and installations that cannot be readily identified and recorded later.
 2. Mark copy with the proprietary name and model number of products, materials, and equipment furnished, including substitutions and product options selected.
- B. Format: Submit record Specifications as annotated PDF electronic file.

2.3 RECORD PRODUCT DATA

- A. Preparation: Mark Product Data to indicate the actual product installation where installation varies substantially from that indicated in Product Data submittal.
1. Give particular attention to information on concealed products and installations that cannot be readily identified and recorded later.
 2. Include significant changes in the product delivered to Project site and changes in manufacturer's written instructions for installation.

- B. Format: Submit record Product Data as annotated PDF electronic file.

2.4 MISCELLANEOUS RECORD SUBMITTALS

- A. Assemble miscellaneous records required by other Specification Sections for miscellaneous record keeping and submittal in connection with actual performance of the Work. Bind or file miscellaneous records and identify each, ready for continued use and reference.
- B. Format: Submit miscellaneous record submittals as PDF electronic file.

PART 3 - EXECUTION

3.1 RECORDING AND MAINTENANCE

- A. Recording: Maintain one copy of each submittal during the construction period for project record document purposes. Post changes and revisions to project record documents as they occur; do not wait until end of Project.
- B. Maintenance of Record Documents and Samples: Store record documents and Samples in the field office apart from the Contract Documents used for construction. Do not use project record documents for construction purposes. Maintain record documents in good order and in a clean, dry, legible condition, protected from deterioration and loss. Provide access to project record documents for Architect's reference during normal working hours.

END OF SECTION 01 78 39

SECTION 26 00 00

ELECTRICAL TABLE OF CONTENTS

PART 1 GENERAL 1

1.1 GENERAL REQUIREMENTS AND REFERENCES 1

1.2 DEFINITIONS 1

1.3 SCOPE 2

1.4 RELATED WORK UNDER OTHER SECTIONS 3

1.5 REGULATORY REQUIREMENTS 3

1.6 SUBMITTALS 4

1.7 SURVEYS AND MEASUREMENTS 7

1.8 COORDINATION 7

1.9 INSTALLATION REQUIREMENTS 8

1.10 TYPICAL DETAILS 8

1.11 SLEEVES, INSERTS 8

1.12 CORING, DRILLING 8

1.13 FIRESTOPPING, SMOKEPROOFING AND WATERPROOFING 8

1.14 COMMISSIONING OF SYSTEMS 9

1.15 ACCESSIBILITY 9

1.16 SUPPLEMENTARY SUPPORTING STEEL 9

1.17 TOOLS AND EQUIPMENT 9

1.18 PORTABLE AND DETACHABLE PARTS 9

1.19 RECORD DRAWINGS, PROJECT CLOSEOUT 9

1.20 GUARANTEE/WARRANTY 10

1.21 OPERATING, INSTRUCTION AND MAINTENANCE MANUALS 11

1.22 SERVICE CHARACTERISTICS 12

1.23 QUALITY ASSURANCE 12

1.24 DELIVERY, STORAGE AND HANDLING 13

1.25 STAGING AND SCAFFOLDING 13

1.26 EXTRA MATERIALS 13

1.27 SEISMIC REQUIREMENTS 13

1.28 PHASING, DEMOLITION AND MAINTAINING EXISTING SERVICES 14

PART 2 – PRODUCTS 14

2.1 GENERAL 14

2.2 RACEWAYS AND FITTINGS 15

2.3 WIRING MATERIALS 16

2.4 OUTLET, JUNCTION, PULL BOXES AND WIRING TROUGHS FOR ALL SYSTEMS 17

2.5 WIRING DEVICES 18

2.6 GROUNDING REQUIREMENTS 19

2.7 PHASING AND COLOR CODING 19

2.8 FIRE ALARM SYSTEM 20

2.9 ACCESS PANELS 29

PART 3 EXECUTION 29

3.1 BASIC REQUIREMENTS 29

3.2 TESTING REQUIREMENTS & INSTRUCTIONS 30

3.3 BRANCH CIRCUITRY 33

3.4 REQUIREMENTS GOVERNING ELECTRICAL WORK IN DAMP OR WET LOCATIONS 34

3.5 REQUIREMENTS GOVERNING ELECTRIC WORK IN AIR HANDLING SPACES 35

3.6 IDENTIFICATION AND TAGGING 35

3.7 LIMITING NOISE PRODUCED BY ELECTRICAL INSTALLATION..... 37

3.8 SUPPORTS AND FASTENINGS..... 37

3.9 SPLICING AND TERMINATING WIRES AND CABLES 38

3.10 PULLING WIRES INTO CONDUITS AND RACEWAYS 39

3.11 REQUIREMENTS FOR THE INSTALLATION OF JUNCTION BOXES, OUTLET BOXES AND
PULL BOXES..... 39

3.12 LOCATING AND ROUTING OF CIRCUITRY..... 41

3.13 INSTALLING CIRCUITRY..... 43

SECTION 26 00 00

ELECTRICAL

PART 1 GENERAL

1.1 GENERAL REQUIREMENTS AND REFERENCES

- A. Include "General Requirements" and applicable parts of Division 1 as part of this section.
- B. Examine all other sections of the Specifications for requirements which affect work under this Section whether or not such work is specifically mentioned in this section. Where paragraphs of this section conflict with similar paragraphs of Division 1, requirements of this section shall prevail.
- C. Coordinate work with that of all other trades affecting, or affected by work of this section. Cooperate with such trades to assure the steady progress of all work under the Contract.
- D. The Subcontractor shall be responsible for filing all documents, payment of all fees, and securing of all inspections and approvals necessary for the work of this section.
- E. The Electrical Subcontractor shall carry in the Bid Price all Municipal back charges for all materials furnished and work performed by them in conjunction with this Contract and pay same to the respective agency upon demand. The Electrical Subcontractor shall not be entitled to additional compensation after the submittal of his bid price should he fail, for any reason, to obtain the total back charge costs to be incurred by the Municipal Agencies.

1.2 DEFINITIONS

- A. As used in this section, "provide" means "furnish and install", and "POS" means "Provided Under Other Sections".
- B. As used in the Contract Drawings and Specifications for Electrical work, certain non-technical words shall be understood to have specific meanings as follows, regardless of indications to the contrary in the General Conditions of other documents governing the Electrical work.
 - 1. "Furnish" means: Purchase and deliver to the project site complete with every necessary appurtenance and support, all as part of the Electrical work. Purchasing shall include payment of all sales taxes and other surcharges as may be required to assure that purchased item(s) are free of all liens, claims, or encumbrances.
 - 2. "Install" means: Unload at the delivery point at the site and perform every operation necessary to establish secure mounting and correct operation at the proper location in the project, all as part of the Electrical work.
 - 3. "Provide" means: "Furnish" and "Install".
 - 4. "New" means: Manufactured within the past two (2) years and never before used.
- C. Except where modified by a specific notation to the contrary, it shall be understood that the indication and/or description of any electrical item in the Contract Drawings or

Specifications for Electrical work carries with it the instruction to furnish, install and connect the item as part of the Electrical work, regardless of whether or not this instruction is explicitly stated.

- D. It shall be understood that the Specifications and Drawings for Electrical work are complimentary and are to be taken together for a complete interpretation of the Electrical work except that indications on the Contract Drawings, which refer to an individual element of work, take precedence over the Specifications where they conflict.

1.3 SCOPE

- A. Perform work and provide material and equipment as shown on Drawings and as specified or indicated in this Section of the Specifications. Completely coordinate work of this Section with work of other trades and provide a complete and fully functional installation.
1. Grounding and bonding of all electrical systems and equipment.
 2. Fire alarm system complete with all devices and wiring including municipal connections.
 3. Wiring devices (switches and receptacles) complete with associated wallplates.
 4. Testing of all electrical systems.
 5. Access panels (furnish only).
 6. Coordination between electrical and other trades.
 7. All other systems hereinafter specified or indicated on the Contract Drawings, complete, leaving ready an electrical system in perfect operating condition.
 8. All required staging and scaffolding of any height.
- B. Drawings and Specifications form complimentary requirements; provide work specified and not shown, and work shown and not specified as though explicitly required by both. Although work is not specifically shown or specified, provide supplementary or miscellaneous items, appurtenances, devices and materials obviously necessary for a sound, secure and complete installation.
- C. Give notices, file plans, obtain permits and licenses, pay fees and back charges, and obtain necessary approvals from Authorities that have jurisdiction as required to perform work in accordance with all legal requirements and with Specifications, Drawings, Addenda and Change Orders, all of which are part of Contract Documents.
- D. Before submitting bid, visit and carefully examine site to identify existing conditions and difficulties that will affect work of this Section. No extra payment will be allowed for additional work caused by unfamiliarity with site conditions that are visible or readily construed by an experienced observer. Site visit is particularly important because this is renovation work.
- E. Before starting work in a particular area of the project, visit site and examine conditions under which work must be performed including preparatory work done under other

Sections or Contracts or by Owner. Report conditions that might affect work adversely in writing through Contractor to Architect. Do not proceed with work until defects have been corrected and conditions are satisfactory. Commencement of work shall be construed as complete acceptance of existing and preparatory work.

1.4 RELATED WORK UNDER OTHER SECTIONS

- A. The following items are not included in this section and will be performed under the designated sections.
1. Temporary Facilities.
 2. Masonry: All openings in masonry walls.
 3. Waterproofing, Dampproofing and Caulking.
 4. Roofing and Flashing.
 5. Painting: All painting except as specified herein.
 6. Finish Carpentry and Millwork.
 7. Steel Doors and Frames.
 8. Finish Hardware.
 9. Fire Protection.

1.5 REGULATORY REQUIREMENTS

- A. Comply with all applicable Federal and State laws, and all Local Codes, By-laws and Ordinances.
- B. Where provisions of the Contract Documents conflict with any codes, rules or regulations, the latter shall govern. Where the contract requirements are in excess of applicable codes, rules or regulations, the contract provisions shall govern unless the Architect rules otherwise.
- C. Request inspections from Authorities having jurisdiction, obtain all permits and pay for all fees and inspection certificates as applicable and/or required. All permits and certificates shall be turned over to the Owners at the completion of the work. Copies of permits shall be given to the resident engineer prior to the start of work.
- D. Unless otherwise specified or indicated, materials and workmanship and equipment performance shall conform with the latest edition of the following standards, codes, Specifications, requirements and regulations:
1. State Building Code.
 2. State Electrical Code.
 3. National Fire Protection Association (NFPA).
 4. Local Town Regulations and By-Laws.

5. Underwriter's Laboratories, Inc. (UL).
 6. National Electrical Manufacturer's Association (NEMA).
 7. American National Standards Institute (ANSI).
- E. All Electrical work shall meet or exceed any other state and local codes and/or Authorities having jurisdiction including all other standards indicated herein.

1.6 SUBMITTALS

- A. This paragraph shall supplement Division 1.
- B. Definitions:
1. Shop Drawings: Information prepared by the Contractor to illustrate portions of the work in more detail than shown in the Contract Documents.
 2. Manufacturer's Product Data: Information prepared by the manufacturer which depicts standard equipment.
- C. Submittals, Procedures and Format:
1. Review submittal packages for compliance with Contract Documents and then submit to Architect for review. Submit transparency and two (2) blue or black-line reproductions of each Shop Drawing larger than 8-1/2" x 11". Submit eight (8) sets of each smaller shop drawing. After review, transparency original of each large Shop Drawing and six (6) sets of each small shop drawing will be returned with reviewer's marks. Electronically submitted shop drawings are acceptable.
 2. Each Shop Drawing shall indicate in title block, and each Product Data package shall indicate on cover sheet, the following information:
 - a. Title.
 - b. Name and location of project.
 - c. Names of Architect, Engineer, Contractor and Subcontractor(s).
 - d. Names of Manufacturer, Supplier, Vendor, etc.
 - e. Date of submittal.
 - f. Whether original submittal or resubmitted.
 3. Shop Drawings and/or Manufacturer's Product Data shall contain detailed dimensional Drawings, accurate and complete description of materials of construction, manufacturer's published performance characteristics and capacity ratings (performance data alone is not acceptable), electrical requirements and wiring diagrams. Drawings shall clearly indicate location (terminal block or wire number), voltage and function for all field terminations, and other information necessary to demonstrate compliance with all requirements of Contract Documents.
- D. Acceptable Manufacturers:
1. The Architect's Mechanical/Electrical design for each project is based on the single manufacturer listed in the schedule or shown on the Contract Drawings. In Division 26 of these Specifications certain "Alternate Manufacturers" are listed as being acceptable. These are acceptable only if, as a minimum, they:

- a. Meet all performance criteria listed in the schedules and outlined in the Specifications.
 - b. Have identical operating characteristics to those called for in the Specifications.
 - c. Fit within the available space it was designed for, including space for maintenance and component removal, with no modifications to either the space or the product. Clearances to walls, ceilings and other equipment will be at least equal to those shown on the Contract Documents. The fact that a manufacturer's name appears as acceptable shall not be taken to mean the Architect has determined that the manufacturer's products will fit within the available space. This determination is solely the responsibility of the Contractor.
 - d. For equipment mounted in areas where structural matters are a consideration, the products must have a weight no greater than the product listed in the schedules or Specifications.
 - e. Products must adhere to all architectural considerations including, but not limited to, being the same size and of the same physical appearance as scheduled or specified products.
- E. Substitutions: Substitution of products by manufacturers other than those listed shall only be done in accordance with subparagraph "F" "Substitutions and Deviations".
- F. Substitutions and Deviations:
1. Deviations from the Contract Documents and the substitution of materials or equipment relative to the "Acceptable Manufacturers" referred to above shall be requested individually in writing whether deviations result from field conditions, standard shop practice, or other cause. Submit letter with transmittal of Shop Drawings which flags the substitution or deviation to the attention of the Architect. The letter shall describe changes in the system shown and physical characteristics (connections to adjacent materials, electrical services, service access requirements, and other characteristics), and differences in operating characteristics or cycles.
 2. Without letters flagging the substitution or deviation to the Architect, it is possible that the Architect may not notice such substitution or deviation or may not realize its ramifications. Therefore, if such letters are not submitted to the Architect, the Contractor shall hold the Architect and his consultants harmless for any and all adverse consequences resulting from the deviations being implemented. Adverse consequences shall include, but not be limited to, excessive noise, excessive maintenance, shortened longevity, spatial coordination problems, and inadequate performance versus scheduled design. This shall apply regardless of whether the Architect has reviewed or approved Shop Drawings containing the deviation, and will be strictly enforced.
 3. Do not request substitute materials or equipment unless identical material or equipment has been operated successfully for at least three (3) consecutive years. Such materials and equipment shall be a regular cataloged item shown in the current catalog of the manufacturer. When deviation or substitution is permitted, coordinate fully with related changes to Architectural, Structural, Plumbing, Fire Protection, Mechanical, and other work. Ensure that related changes necessary for coordination of substituted items are made within the Contract Price. Assume full responsibility for safety, operation and performance of the altered system. Any extra costs incurred to the project based on the use of alternate manufacturers shall be borne by the Contractor who has requested the substitution.

4. Substitutions of equipment, systems, etc. requiring approval of local Authorities must comply with such regulations and be filed by the Contractor (should filing be necessary).
5. Consideration will not be given to claims that the substituted item meets the performance requirements with lesser construction. Performance, as delineated in schedules and in the Specifications, shall be interpreted as minimum performance.
6. Approval of proposed deviations or substitutions, if any, will be made at discretion of Architect.
7. If equipment is proposed for substitution that is not tested and rated according to industry-wide standards, the Architect shall have the right to have performance tests completed, at the Contractor's expense, to confirm the manufacturer's performance claims.

G. Submittal Notations: Submittals will be returned from the Architect marked as illustrated below:

<input type="checkbox"/> NO EXCEPTION TAKEN	<input type="checkbox"/> ACCEPTED AS NOTED
<input type="checkbox"/> NOT ACCEPTED	<input type="checkbox"/> REVISE AND RESUBMIT

1. Checking is only for general conformance with the design concept of the project and general compliance with the information given in the Contract Documents. Any action shown is subject to the requirements of the Contract Drawings and Specifications. Contractor is responsible for dimensions which shall be confirmed and correlated at the job site; fabrication process and techniques of construction; coordination of his work with that of all other trades; and the satisfactory performance of his work.

H. Schedule: Incorporate the Shop Drawing review period into the construction schedule so that work is not delayed. Contractor shall assume full responsibility for delays caused by not incorporating the following Shop Drawing review time requirements into his project schedule. Allow at least ten (10) working days, exclusive of transmittal time, for review each time Shop Drawing is submitted or resubmitted.

I. List of Proposed Equipment and Materials: Within four (4) weeks after Award of Contract and before ordering materials or equipment, submit a complete list of proposed materials and equipment and indicate manufacturer's names and addresses. No consideration will be given to partial lists submitted out of sequence.

J. Responsibility:

1. The intent of submittal review is to check for capacity, rating, and certain construction features. Contractor shall ensure that work meets requirements of the Contract Documents regarding information that pertains to fabrication processes or means, methods, techniques, sequences and procedures of construction; and for coordination of work of this and other Sections. Work shall comply with submittals marked "REVIEWED" to extent that they agree with the Contract Documents. Submittal review shall not diminish responsibility under this Contract for dimensional coordination, quantities, installation, wiring, supports

and access for service, nor the shop drawing errors or deviations from requirements of the Contract Documents. The Architect's noting of some errors while overlooking others will not excuse the Contractor for proceeding in error. Contract Document requirements are not limited, waived, nor superseded in any way by review.

2. Inform Subcontractors, Manufacturers, Suppliers, etc. of scope and limited nature of review process and enforce compliance with the Contract Documents.
- K. Material and equipment requiring Shop Drawing and/or Manufacturer's Data Submittals shall include but not be limited to:
1. Wiring devices and wall plates.
 2. Fire alarm system with wiring diagram and schedule.
 3. Wiring and cables.
 4. Conduit.
 5. Boxes and fittings.

1.7 SURVEYS AND MEASUREMENTS

- A. Base all required measurements, both horizontal and vertical, on reference points established by the General Contractor and be responsible for the correct laying out of the Electrical work. In the event of a discrepancy between actual measurements and those indicated, notify the General Contractor in writing. Do not proceed with the work required until written instructions have been issued by the General Contractor.

1.8 COORDINATION

- A. Electrical Drawings are diagrammatic. They indicate general arrangements of Electrical systems and other work. They do not show all offsets required for coordination nor do they show the exact routings and locations needed to coordinate with Structural and other trades and to meet Architectural requirements.
- B. Work shall be performed in cooperation with other trades on the project and so scheduled as to allow speedy and efficient completion of the work.
- C. Furnish to other trades advance information on locations and sizes of all frames, boxes, sleeves and openings needed for their work. Furnish information and Shop Drawings necessary to allow trades affected by the work to install their work properly and without delay.
- D. In all spaces, prior to installation of visible material and equipment, including access panels, review Architectural Drawings for exact locations and where not definitely indicated, request information from Architect. Where the Electrical work shall interfere with the work of other trades, assist in coordinating the space conditions to make satisfactory adjustments before installation. Without extra cost to the Owners, make reasonable modifications to the work as required by normal Structural interferences. Pay the General Contractor for additional openings, or relocating and/or enlarging existing openings through concrete floors, walls, beams and roof required for any work which was not properly coordinated. Maintain maximum headroom at all locations. All piping, duct, conduit, and associated components to be as tight to underside of structure as possible.

- E. If any Electrical work has been installed before coordination with other trades so as to cause interference with the work of such trades, all necessary adjustments and corrections shall be made by the trades involved without extra cost to the Owners.
- F. Where conflicts or potential conflicts exist and engineering guidance is desired, submit sketch of proposed resolution to Architect for review and approval.
- G. Protect all materials and work of other trades from damage which may be caused by the Electrical work, and repair all damages without extra cost to the Owners.

1.9 INSTALLATION REQUIREMENTS

- A. The arrangement of all Electrical work shown on the Contract Drawings is diagrammatic only and indicates the minimum requirements of the work. Conditions at the building including actual measurements shall determine the details of the installation. All work shall be laid out and installed so as to require the least amount of cutting and patching.
- B. Review the Architectural Drawings and Specifications before ordering any material and equipment. Any discrepancies shall be brought to the attention of the Architect for his determination prior to proceeding with the work.

1.10 TYPICAL DETAILS

- A. Typical details where shown on the Contract Drawings shall apply to each and every item of the project where such items are applicable. They are not repeated in full on the Contract Drawings, which in many cases are diagrammatic only, but with the intention that such details shall be incorporated in full. Any alternate method proposed for use by the Contractor shall have the prior approval of the Architect.

1.11 SLEEVES, INSERTS

- A. Furnish and install all sleeves, inserts, anchor bolts and similar items to be set into masonry or concrete, as required for Mechanical and Electrical work. Internal diameter of sleeve shall be 1/2" larger than the outside diameter of the pipe or insulation covered line passing through it.

1.12 CORING, DRILLING

- A. Core, cut and/or drill all small holes 4.5" diameter or less in walls, floors and ceiling required for the installation of sleeves, supports, and conduit for the Electrical work.

1.13 FIRESTOPPING, SMOKEPROOFING AND WATERPROOFING

- A. All penetrations made through fire rated assemblies (structures or partitions) shall be completely and properly fire sealed with the appropriate firestop systems installed in accordance with the Manufacturer's recommendations. The firestop material UL listed fire rating shall match or exceed the fire rated assemblies. Verify with Architect if project is utilizing a specified product. If not, provide product manufactured by Hilti, Nelson or STI.
- B. Provide waterproofing of all materials which penetrate a floor, exterior wall, slab or roof. All sleeves shall extend a minimum of 3 inches above floor or roof. All penetrations through building foundation walls shall utilize Link-Seal products or approved equal.

1.14 COMMISSIONING OF SYSTEMS

- A. Provide the services of a factory authorized technician to instruct and direct the Owner in the operation and maintenance of indicated systems and/or equipment. The Electrical Subcontractor shall be available throughout the entire Commissioning Phase to operate the systems/equipment. Systems and/or equipment that shall be commissioned include the following:
 - 1. Fire Alarm system.
- B. Upon completion of all tests, the Electrical Subcontractor shall repair and/or replace any defective equipment. Once replaced and/or repaired, all Commissioning shall be performed.
- C. Refer to Section 26 00 00 paragraph 3.2 for additional requirements.

1.15 ACCESSIBILITY

- A. Install all work such that parts requiring periodic inspection, operation, maintenance and repair are readily accessible.
- B. Furnish all access panels appropriate to particular conditions, to be installed by trades having responsibility for the construction of actual walls, floors or ceilings at required locations.

1.16 SUPPLEMENTARY SUPPORTING STEEL

- A. Provide all supplementary (non-structural) steelwork required for mounting or supporting equipment and materials.
- B. Steelwork shall be firmly connected to building construction as required. Locations and methods of attachment shall be approved by the Architect.
- C. Steelwork shall be of sufficient strength to allow only minimum deflection in conformity with manufacturer's published requirements.
- D. All supplementary steelwork shall be installed in a neat and workmanlike manner parallel to floor, wall and ceiling construction: all turns shall be made at forty-five and ninety degrees, and/or as dictated by construction and installation conditions.
- E. All manufactured steel parts and fittings shall be galvanized.

1.17 TOOLS AND EQUIPMENT

- A. Provide all tools and equipment required for the fabrication and installation of the Mechanical and Electrical equipment at the site.

1.18 PORTABLE AND DETACHABLE PARTS

- A. Contractors shall retain in their possession all portable and/or detachable parts and portions of materials, devices, equipment, etc. necessary for the proper operation and maintenance of the Mechanical and Electrical systems until final completion of the work, at which time they shall be handed over to the Owners.

1.19 RECORD DRAWINGS, PROJECT CLOSEOUT

- A. As work progresses and for the duration of Contract, maintain a complete and separate set of prints of Contract Drawings at job site at all times. Record work completed and all

changes from original Contract Drawings clearly and accurately including work installed as a modification or addition to the original design. Work shall be updated on a weekly basis and shall be made available for review by Architect. Failure to perform this work shall be reason for withholding requisition payments. In addition, take photographs of all concealed equipment in gypsum board ceilings, shafts, and other concealed, inaccessible work. At completion of work, make copies of photographs with written explanation on back. These shall become part of Record Documents.

- B. At completion of work prepare a complete set of Record Drawings utilizing AutoCAD produced drawings showing all systems as actually installed, including all fire alarm and electrical circuitry. Submit three (3) sets of prints to Architect for comments as to compliance with this section.
- C. The Architect will not certify the accuracy of the Record Drawings. This is the sole responsibility of the Electrical Contractor.
- D. This trade shall submit the Record Drawings for approval by the Fire and Building Departments in a form acceptable to the departments, when required by the jurisdiction.
- E. Record Drawings shall show record condition of details, sections, riser diagrams, control changes and corrections to schedules. Schedules shall show actual manufacturer, make and model numbers of final equipment installation.

1.20 GUARANTEE/WARRANTY

- A. Guarantee and 24 Hour Service:
 - 1. Guarantee Work of this Section in writing for not less than one (1) year following the date of acceptance by the Owner. If the equipment is used for temporary power etc, prior to acceptance by the Owner, the bid price shall include an extended period of warranty covering the one (1) year of occupancy, starting from the date of acceptance by the Owner. The guarantee shall repair or replace defective materials, equipment, workmanship and installation that develop within this period, promptly and to the Architect's satisfaction and correct damage caused in making necessary repairs and replacements under guarantee within Contract Price.
 - 2. In addition to guarantee requirements of Division 1 and of Subparagraph A above, obtain written equipment and material warranties offered in manufacturer's published data without exclusion or limitation, in Owner's name.
 - 3. Upon receipt of notice from the Owner of failure of any part of the systems or equipment during the warranty period, the affected part or parts shall be replaced by this Contractor without any reimbursement.
 - 4. Replace material and equipment that require excessive service during guarantee period as defined and as directed by Architect.
 - 5. Provide 24 hour service beginning on the date the project is accepted by the Owner, whether or not fully occupied, and lasting until the termination of the guarantee period. Service shall be at no cost to the Owner. Service can be provided by this Contractor or a separate service organization. Choice of service organization shall be subject to Architect and Owner approval. Submit name and

a phone number that will be answered on a 24 hour basis each day of the week, for the duration of the service.

6. Submit copies of equipment and material warranties to Architect before final payment.
7. At end of guarantee period, transfer manufacturer's equipment and material warranties still in force to Owner.
8. This paragraph shall not be interpreted to limit Owner's rights under applicable codes and laws and under this Contract.
9. PART 2 paragraphs of this Specification may specify warranty requirements that exceed those of this paragraph. Those paragraphs shall govern.
10. Use of systems provided under this Section for temporary services and facilities shall not constitute Final Acceptance of Work by Owner, and shall not initiate the guarantee period.
11. Provide manufacturer's engineering and technical staff at site to analyze and rectify problems that develop during guarantee period immediately. If problems cannot be rectified immediately to Owner's satisfaction, advise the Architect in writing, describe efforts to rectify situation, and provide analysis of cause of problem. The Architect and/or Engineer will direct course of action.

1.21 OPERATING, INSTRUCTION AND MAINTENANCE MANUALS

- A. Refer to Section 01700 – CONTRACT CLOSEOUT for submittal procedures pertaining to operating and maintenance manuals.
- B. Each copy of the approved operating and maintenance manual shall contain copies of approved Shop Drawings, equipment literature, cuts, bulletins, details, equipment and engineering data sheets and typewritten instructions relative to the care and maintenance for the operation of the equipment, all properly indexed. Each manual shall have the following minimum contents:
 1. Table of Contents.
 2. Introduction:
 - a. Explanation of manual and its purpose and use.
 - b. Description of the electrical systems.
 - c. Safety precautions necessary for equipment.
 - d. Illustrations, schematics and diagrams.
 - e. Installation drawing.
 3. Maintenance:
 - a. Maintenance and lubricating instructions.
 - b. Replacement charts.
 - c. Trouble-shooting charts for equipment components.
 - d. Testing instructions for each typical component.
 - e. Two (2) typed sets of instructions for ordering spare parts. Each set

shall include name, price, telephone number and address of where they may be obtained.

4. Manufacturer's Literature:
 - a. The equipment for which Shop Drawings have been submitted and approved.

1.22 SERVICE CHARACTERISTICS

- A. Secondary Building Voltage – High Level: 277/480.
- B. Secondary Building Voltage – Low Level: 120/208.
- C. All equipment and wiring shall be suitable for the applied voltage.

1.23 QUALITY ASSURANCE

- A. The requirements of the State Building Code and Local regulations establish the minimum acceptable quality of workmanship and materials, and all work shall conform thereto unless more stringent requirements are indicated or specified herein.
- B. All work shall comply with the latest editions of the codes as referenced herein.
- C. Follow manufacturer's directions for articles furnished, in addition to directions shown on Drawings or specified herein.
- D. Protect all work, materials, and equipment from damage during process of work. Replace all damaged or defective work, materials and equipment without additional cost to the Owner.
- E. All equipment and materials for permanent installation shall be the products of recognized manufacturers and shall be new.
- F. Equipment and materials shall:
 1. Where normally subject to Underwriters Laboratory Inc. listing or labeling services, be so listed and labeled.
 2. Be without blemish or defect.
 3. Not be used for temporary light and power purposes.
 4. Be in accordance with the latest applicable NEMA standards.
 5. Buy products which will meet with the acceptance of all Authorities having jurisdiction over the work. Where such acceptance is contingent upon having the products examined, tested and certified by Underwriters or other recognized testing laboratory, the product shall be so examined, tested and certified.
- G. Except for conduit, conduit fittings, outlet boxes, wire and cable, all items of equipment or material of one generic type shall be the product of one manufacturer throughout.
- H. For items which are to be installed but not purchased as part of the Electrical work, the

Electrical work shall include:

1. The coordination of their delivery.
 2. Their unloading from delivery trucks driven into any point on the property line at grade level.
 3. Their safe handling and field storage until the time of permanent placement in the project.
 4. The correction of any damage, defacement or corrosion to which they may have been subjected. Replacement, if necessary, shall be coordinated with the Contractor who originally purchased the item.
 5. Field erection and internal wiring as necessary for their proper operation.
 6. Mounting in place, including the purchase and installation of all dunnage, supporting members, and fastenings, necessary to adapt them to architectural and structural conditions.
- I. Items which are to be installed but not purchased as part of the electric work shall be carefully examined upon delivery to the project. Claims that any of these items have been received in such condition that their installation will require procedures beyond the reasonable scope of the electric work will be considered only if presented in writing within one (1) week of the date of delivery to the project of the items in question. The electric work includes all procedures, regardless of how extensive, necessary to put into satisfactory operation, all items for which no claims have been submitted as outlined above.

1.24 DELIVERY, STORAGE AND HANDLING

- A. All materials for the work of this section shall be delivered, stored and handled so as to preclude damage of any nature. Manufactured materials shall be delivered and stored in their original containers, plainly marked with the products' and manufacturer's name. Materials in broken containers or in packages showing watermarks or other evidence of damage, shall not be used and shall be removed from the site.

1.25 STAGING AND SCAFFOLDING

- A. Provide staging and scaffolding for all the work of this section complying with Division 1 requirements.

1.26 EXTRA MATERIALS

- A. Furnish extra materials as indicated below that match products installed, are packaged with protective covering for storage, and are identified with labels clearly describing contents.
1. 10% of total audio/visual appliances installed.
 2. 10% of each total pull stations and smoke detectors installed.

1.27 SEISMIC REQUIREMENTS

- A. Equipment and work shall meet the restraint requirements for the designated Seismic

Design category. This shall include all installation and connections of material and equipment to the building structure. Refer to Structural Drawings for Seismic Design category and ASCE7 for electrical requirements.

1.28 PHASING, DEMOLITION AND MAINTAINING EXISTING SERVICES

- A. During the execution of the work, required relocation, etc., of existing equipment and systems in the existing building areas where new work is to be installed or new connections are scheduled to be made, shall be performed by the Electrical Subcontractor, as required by job conditions and as determined by the Architect in the field, to facilitate the installation of the new system, while demolition, relocation work or new tie ins will be performed. Outages required for construction purposes shall be scheduled for the shortest practical period of time, in coordination with the Owner's designated representative, for specified, mutually agreeable periods of time, after each of which the interruption shall cease and the service shall be restored. This procedure shall be repeated to suit the Owner's working schedule, as many times as required until all work is completed. Any outages of service shall be approved by the Owner, prior to commencing the work. No outages or shutdowns of service shall occur without the written authorization of the Owner prior to commencing the work. Give notice of any scheduled shutdowns, a minimum of two (2) weeks in advance. Owner shall make their best efforts to meet this request without adversely affecting the electric service to the existing building.
- B. Prior to any deactivation and relocation or demolition work, consult the Contract Drawings and arrange a conference with the Architect and Owner's representative in the field to inspect each of the items to be deactivated, removed or relocated. Care shall be taken to protect all equipment designated to be relocated and reused or to remain in operation and be integrated with the new systems.
- C. All deactivation, relocation and temporary tie-ins of electrical systems and equipment shall be provided by the Electrical Subcontractor. All demolition and removal of electrical systems and equipment designed to be demolished shall be provided by the Electrical Subcontractor. Place all demolished electrical materials except hazardous materials (PCB lighting ballasts, fluorescent lamps, etc.) as determined by the Authority Having Jurisdiction in General Contractor's dumpster. All hazardous electrical materials shall be legally disposed of by the Electrical Subcontractor.
- D. The Owner reserves the right to inspect the material scheduled for removal and salvage any items he deems usable as spare parts.
- E. Phasing:
 - 1. The Electrical Subcontractor shall construct the subject project in phases as directed by the Architect to suit the project progress schedule, as well as the completion date of the project.
 - 2. For additional information related to phasing, review the General Conditions and Supplementary Conditions and the Architectural Drawings.

PART 2 – PRODUCTS

2.1 GENERAL

- A. Product Specifications are written in such a manner so as to specify what materials may be used in a particular location or application and therefore do not indicate what is not acceptable or suitable for a particular location or application. As an example: Non-metallic sheathed cable is not specified; therefore it is not acceptable.
- B. For purpose of establishing a standard of quality and not for purposes of limiting completion, the basis of this Specification is upon specified models and types of equipment and materials, as manufactured by specified manufacturers.
- C. In all cases, standard cataloged materials and systems have been selected. Materials such as lighting fixtures specially manufactured for this particular project, and not part of a manufacturer's standard product line, will not be acceptable. In the case of systems, the system components shall be from a single source regularly engaged in supplying such systems. A proposed system made up of a collection of various manufacturers products will be unacceptable.
- D. Where Specifications list manufacturers names and/or "as approved" or "equal approved by Designer", other manufacturers equipment will be considered if equipment meets Specification requirements and has all features of the specified items as are considered essential by the Architect.
- E. All materials shall be new and shall be UL listed.

2.2 RACEWAYS AND FITTINGS

- A. Raceways – General:
 - 1. No raceway shall be used smaller than 3/4" diameter. No conduit shall have more than three (3) 90° bends in any one run, and where necessary, pull boxes shall be provided.
 - 2. Rigid metal conduit (RMC) conforming to, and installed in accordance with, Article 344 of NFPA 70 shall be heavy wall zinc coated steel conforming to American Standard Specifications C80-1 and may be used for service work, exterior work, slab work, and below grade level slab, wet locations, and in mechanical rooms and where raceway may be subjected to mechanical damage, i.e., loading docks, workshops, etc.
 - 3. Intermediate metal conduit (IMC) conforming to, and installed in accordance with Article 342 of NFPA 70 shall be zinc coated steel and may be used in all areas similar to RMC.
 - 4. Thin wall conduit (EMT), conforming to, and installed in accordance with, Article 358 of NFPA 70 shall be zinc coated steel, conforming to industry standards, may be used in masonry block walls, stud partitions, above furred ceilings where exposed but not subject to mechanical damage, and shall be used for fire alarm work.
 - 5. Flexible metal conduit (FMC) conforming to, and installed in accordance with Article 348 of NFPA 70 shall be used for connections to recessed light fixtures, vibrating equipment and motors. All FMC shall be secured and supported in accordance with Article 348 of NFPA 70.
 - 6. Liquidtight flexible metal conduit (LFMC) conforming to, and installed in accordance with Article 350 of NFPA 70 shall be used for connections to light fixtures, vibrating equipment and motors. All LFMC shall be secured and

supported in accordance with Article 350 of NFPA 70. If used on roof applications, all LFMC shall be supported by sleepers approved by the Architect prior to installation.

7. Acceptable Manufacturers:
 - a. Wheatland Tube Company
 - b. Allied Tube
 - c. Western Tube & Conduit
 - d. Carlon
 - e. Perma-Cote Supreme
 - f. Cantex
8. Fittings:
 - a. Provide insulated bushings on all raceways that house conductors #4 AWG or larger at all threaded fittings no matter what the size of the conductor.
 - b. Manufacturer's standard fittings shall be used for raceway supports.
 - c. Expansion Fittings: Expansion fittings shall be used where structural and concrete expansion joints occur and shall include a ground strap.
 - d. Couplings for rigid metal conduit and IMC shall be threaded type. Provide insulated bushings.
 - e. All fittings for EMT conduit shall be steel. No die-cast fittings are allowed. Set screw and compression connectors are allowed.
 - f. Threadless fittings for EMT shall be watertight compression type. All fittings shall be concrete tight.
 - g. Cable supports in vertical raceways shall be of the split wedge type. Armored cable supports for vertical runs to be of wire mesh basket design.
 - h. Wall entrance seals shall be equal to O.Z. Gedney type "WSK" or Link-Seal.
 - i. Couplings, elbows and other fittings used with rigid nonmetallic raceways shall be of the solvent cemented type to secure a waterproof installation.
 - j. Acceptable manufacturers:
 - 1) O.Z. Gedney
 - 2) Crouse Hinds
 - 3) American Fittings
 - 4) Hubbell
 - 5) Thomas & Betts

2.3 WIRING MATERIALS

- A. Building Wire and Cable shall be copper with 600V insulation, THWN for branch circuitry and XHHW for feeders.
- B. Conductors shall be of soft drawn 98% minimum conductivity properly refined copper, solid construction where No. 10 AWG and smaller, stranded construction where No. 8 AWG and larger.
- C. Exterior of wires shall bear repetitive markings along their entire length indicating conductor size, insulation type and voltage rating.
- D. Exterior of wires shall be color coded, so as to indicate a clear differentiation between

each phase and between each phase and neutral. In all cases, grounded neutral wires and cables shall be identified by the colors "white" or "gray". In sizes and insulation types where factory applied colors are not available, wires and cables shall be color coded by the application of colored plastic tapes in overlapping turns at all terminal points, and in all boxes in which splices are made. Colored tape shall be applied for a distance of 6 inches along the wires and cables, or along their entire extensions beyond raceway ends, whichever is less.

- E. Final connections to motors shall be made with 18" of neoprene sheathed flexible conduit.
- F. Minimum branch circuit conductor size shall be No. 12 AWG installed in conduit.
- G. Fire alarm system wiring shall be per manufacturer's recommendations.

Other wires and cables required for the various systems described elsewhere in this section of the Specifications shall be as specified herein, as shown on the Contract Drawings, or as recommended by the manufacturer of the specific equipment for which they are used, all installed in conduit.

- H. Metal clad sheathed cable NFPA 70, type MC may be used for branch circuitry where shown and where run concealed and not subject to physical damage. All type MC cable used shall contain a full size insulated ground conductor. All conductors shall be copper. All type MC cable insulation used shall have voltage rating of 600 volts, shall have a temperature rating of 75° C, and shall be thermoplastic material. Armor material shall be steel and armor design shall be interlocked metal tape. Fire alarm rated MC cable may be used for fire alarm work where concealed and acceptable to the Local Authority Having Jurisdiction.
- I. Wiring materials shall be manufactured by Southwire, Prysmian, General Cable, or equal.

2.4 OUTLET, JUNCTION, PULL BOXES AND WIRING TROUGHS FOR ALL SYSTEMS

A. Outlets:

- 1. Each outlet in wiring or raceway systems shall be provided with an outlet box to suit conditions encountered. Boxes installed in normally wet locations shall be of cast-metal type having hubs. Concealed boxes shall be cadmium plated or zinc coated sheet metal type. Old work boxes with Madison clamps are not allowed in new construction.
- 2. Each box shall have sufficient volume to accommodate number of conductors in accordance with requirements of NFPA 70. Boxes shall not be less than 1-1/2" deep unless shallower boxes are required by structural conditions and are specifically approved by Architect. Ceiling and bracket outlet boxes shall not be less than 4" octagonal except that smaller boxes may be used where required by particular fixture to be installed. Flush or recessed fixtures shall be provided with separate junction boxes when required by fixture terminal temperature requirements. Switch and receptacle boxes shall be 4" square or of comparable volume.
- 3. Acceptable Manufacturers:
 - a. Appleton
 - b. Crouse Hinds
 - c. Steel City
 - d. RACO

- B. Pull and Junction Boxes: Where necessary to terminate, tap off, or redirect multiple

raceway runs or to facilitate conductor installation, furnish and install appropriately designed boxes. Boxes shall be fabricated from code gauge steel assembled with corrosion resistant machine screws. Box size shall be as required by Code. Where intermediate cable supports are necessary because of box dimensions, provide insulated removable core brackets to support conductors. Junction boxes are to be equipped with barriers to separate circuits. Where splices are to be made, boxes shall be large enough to provide ample work space. All conductors in boxes are to be clearly tagged to indicate characteristics. Boxes shall be supported independently of raceways. Junction boxes in moist or wet areas shall be galvanized type. Boxes larger than 4 inches square shall have hinged covers. Boxes larger than 12 inches in one dimension will be allowed to have screw fastened covers, if a hinged cover would not be capable of being opened a full 90 degrees due to installation location.

2.5 WIRING DEVICES

- A. Provide wiring device type plates for all wall-mounted devices. All wall plates shall be smooth high impact nylon for all areas, color as directed by the Architect. Provide galvanized steel for all Utility, Electric and Mechanical Rooms.
- B. Wiring devices standard for the project (i.e., with no specific type indicated) shall conform to the following:
 - 1. Visible part colors of wiring devices shall be as directed by the Architect for all areas. Provide brown devices for all Utility, Electrical and Mechanical rooms.
 - 2. Exclude compact or “despard” type devices.
- C. Wiring device switches shall be toggle type, A.C. quiet design, specification grade, 20 amps on 120 volt circuits. Switches shall be mounted 48” to center line above finished floor unless noted otherwise.
 - 1. Single pole switch shall be equal to Hubbell No. 1221.
 - 2. Double pole switch shall be equal to Hubbell No. 1222.
 - 3. Three-way switch shall be equal to Hubbell No. 1223.
 - 4. Four-way switch shall be equal to Hubbell No. 1224.
 - 5. Single pole pilot light switch shall be equal to Hubbell No. HBL 1221PL.
 - 6. Equivalent 277 volt 20 amp switches shall be used where required.
- D. Standard duplex convenience receptacles shall be 125 volt, 20 amps, three wire (two circuit wires plus ground), “U-bar” ground NEMA slot configuration 5-20R specification grade. Receptacles shall be mounted 18” to center line above finished floor unless noted otherwise.
 - 1. Equal to Hubbell No. 5362.
 - 2. Where indicated on plans provide receptacles with ground fault current interrupters, UL Class A; 20A, 125V to be equal to Hubbell No. GF5362. All GFI receptacles shall be self-testing type in compliance with UL 943.

- E. Non-standard convenience receptacles and special purpose power supply receptacles shall be as listed on plans.
- F. Devices and device plates for flush wall devices which are not integrally equipped with same, shall be as directed by the Architect.
- G. For unfinished spaces, plates for surface-mounted wall devices which are not integrally equipped with same, shall be galvanized sheet steel, formed raised type which does not overlap box. Where for switches, such plates shall have toggle guards.
- H. Where more than one wiring device is indicated in the same location, the devices shall be mounted in gang under a common wall plate.
- I. Mount duplex convenience and power receptacles vertically with grounding posts at top of device unless otherwise indicated. Locate grounding post to left when horizontal mounting is indicated.
- J. Wiring devices and associated hardware shall be manufactured by Leviton, Hubbell or Pass and Seymour.

2.6 GROUNDING REQUIREMENTS

- A. Ground all systems and equipment in accordance with best industry practice, the requirements of NFPA 70, Article 250 and the following:
 1. Provide grounding bonds between all metallic conduits of the light and power system which enter and leave cable chambers or other non-metallic cable pulling and splicing boxes. Accomplish this by equipping the conduits with bushings of the grounding type individually cross connected.
 2. Provide supplementary ground bonding where metallic conduits terminate at metal clad equipment (or at the metal pull box of equipment) for which a ground bus is specified. Accomplish this by equipping the conduits with bushings of the grounding type connected individually by means of jumpers to the ground bus. Exclude the jumpers where directed. This exclusion will be required where an isolated ground for electronic equipment is to be maintained.
 3. Each grounding type bushing shall have the maximum ground wire accommodation available in standard manufacture for the particular conduit size. Connection to bushing shall be with wire of this maximum size.
 4. The central equipment for the fire protective alarm system and telephone system shall have its grounding terminal connected to the grounding electrode by means of a No. 6 green coded insulated conductor, run in 3/4" conduit. Utilize a ground clamp of a type specifically manufactured for the purpose.

2.7 PHASING AND COLOR CODING

- A. The insulation or covering of each wire or cable shall be color coded so as to provide for circuit identification as specified below:

120/208 V Circuits	277/480V	Phase Circuits
Black	Brown	A
Red	Orange	B
Blue	Yellow	C

White	Grey	Neutral
Green	Green with Yellow Tracer	Equipment Ground

- B. Color coding shall be achieved by one of the following methods:
1. The insulation or covering shall be coded during manufacture by use of one of the following methods:
 - a. Colored compounds.
 - b. Colored coatings.
 2. In sizes and insulation types where factory applied colors are not available, wires and cables shall be color coded by the application of colored plastic tapes in overlapping turns at all terminal points, and in all boxes in which splices are made.
- C. The same colored cable shall be connected to the same phase throughout the project.
- D. In general, building load centers and panelboards shall be phased "A", "B", "C", left to right. The neutral, although it may be in different locations for different equipment, shall be identified.

2.8 FIRE ALARM SYSTEM

- A. Scope:
1. Provide complete networked analog/addressable fire detection, evacuation alarm and control network in compliance with all specifications, drawings and applicable code requirements.
 2. System shall be a networked microprocessor based fire alarm system which will integrate peripheral devices onto system via digital data communications.
 3. Each initiating device shall have full analog detection capabilities; identify its' exact location, and shall operate as described elsewhere in these specifications.
 4. Work in this section, as shown or specified, shall be in accordance with related contract documents.
 5. Provide automatic and manual, closed circuit, multiplex fire alarm communications according to contract documents, wired, connected and left in first class operating condition.
 6. Final connections, testing, and adjusting of system shall be done under direct supervision of system supplier.
 - a. System design and installation shall conform to following standards:
 - 1) Equipment shall be UL listed for its intended purpose, including UL 864 (UOJZ, UOXX, UOQY and UUKL), 1480 and 1971.
 - b. NFPA standards 70, 72, 90A, 92A, and 101.
 - c. Current State Building, Electrical and Life Safety Codes.
 - d. Americans with Disabilities Act (ADA).
 - e. Requirements of local authorities having jurisdiction, including permitting and acceptance procedures.
 7. Shop Drawings shall include:

- a. Complete point-to-point riser diagram showing all equipment and size, type and number of conductors and devices.
 - b. Large scale drawings of control panels, annunciators, transponders, showing module placement and spare capacity allowances.
 - c. Complete, itemized bill of materials with quantities, descriptions.
 - d. Original catalog data sheets to assure compliance with these specifications. This equipment shall be subject to approval, and no equipment shall be ordered without prior approval.
 - e. Calculations to support size of standby batteries, notification appliance circuits (NAC) and audio amplifiers submitted. Circuit calculations shall demonstrate proper current draw, voltage drop, wire size considerations and spare capacity allowances. Calculations shall be based on UL nameplate RMS voltage ratings. NAC calculations shall demonstrate 25 percent spare capacity.
 - f. Copy of Original Equipment Manufacturer's Warranty Statement.
 - g. Complete description of system Sequence of Operation.
 - h. Details of any special installation procedures.
 - i. Complete floor plans showing network nodes and all device locations and corresponding addresses. Point identification lists shall be included to ensure proper coordination of alarm messages and shall include each device type address number and corresponding CCO text message.
 - j. Confirmation that equipment supplier will provide on-site project management and supervision during system installation, and perform system testing and instruction.
 - k. Operation and maintenance manuals.
8. Conform to UL and NFPA standards for testing of completed installation by UL approved testing company.
9. O & M Manuals shall include the following:
- a. All information submitted in final reviewed shop drawings.
 - b. As-built documentation which incorporates all modifications to completed system, whether made as field change or by change order.
 - c. Include copy of final test report, Record of Completion, as-built documentation and Fire Alarm Support Contracts as described herein.
- B. Sequence of Operation:
1. Operation of manual station or activation of any automatic alarm initiating device (system smoke, system heat detector, waterflow) shall initiate system-wide but only in respective building/ wing, response according to established response procedures and as follows:
 - a. Initiate transmission of alarm to Municipal Fire Station via Radio Master Box.
 - b. Sound approved temporal code 3 horn signal over all audio circuits throughout entire building.
 - c. Upon any alarm condition, visual signals shall activate throughout the building. Visual notification shall be synchronized in accordance with applicable code requirements and latest NFPA 72 guidelines.
 - d. Flash an alarm LED and sound an audible signal at each FACP and the Fire Command Location. Upon Acknowledgment, the alarm LED shall light steadily and the audible shall silence. Subsequent alarms shall re-initiate this sequence.
 - e. Visually indicate alarm initiating device type and location via LCD display at all Fire Command Centers.
 - f. Operate prioritized outputs to release magnetically held smoke doors

- and magnetically locked doors throughout building.
 - g. Activate exterior W/P beacon.
 - h. Store system events in event history file.
2. Operation of any tamper switch, charging of pre-action system, or activation of other device designated to initiate system Supervisory condition shall cause the following to occur:
- a. Flash Supervisory LED and sound audible tone at FACP. Upon Acknowledgment, LED shall light steadily and audible shall silence. Subsequent Supervisory conditions shall re-initiate this sequence.
 - b. Visually indicate device type and location via LCD display located at FACP and remote annunciators.
 - c. Visually annunciate type of initiating device and its zone, floor or area as required on system annunciators. In addition, Supervisory LED and audible tone will sound. Upon Acknowledgment, LED shall light steadily and audible shall silence. Subsequent Supervisory conditions shall re-initiate this sequence.
 - d. Record event in event history log. Restorations shall likewise be recorded.
3. In event of System Trouble condition such as device removed, loss of AC Power or wiring fault, system Trouble condition shall occur as follows:
- a. Flash Trouble LED and sound audible tone at FACP. Upon Acknowledgment, LED shall light steadily and the audible shall silence. Subsequent Trouble conditions shall re-initiate this sequence.
 - b. Initiate reporting of event to designated staff members via email notification as required and described herein.
 - c. Visually indicate device type and location via LCD display located at FACP and remote annunciators.
 - d. Visually annunciate type of initiating device and its zone, floor or area as required on all system annunciators. In addition, Trouble LED and audible tone shall sound. Upon Acknowledgment, LED shall light steadily and audible shall silence. Subsequent Trouble conditions shall re-initiate this sequence.
 - e. Record event in event history log. Restorations shall likewise be recorded.
- C. General Requirements:
- 1. Fire alarm system shall be designed and UL and FM approved for Fire, Audio Evacuation and Security applications. System operational characteristics shall be stored in non-volatile EEPROM memory, shall be field programmable and capable of being edited with no factory involvement.
 - 2. System shall support analog sensing techniques to monitor individual devices which enables user to set sensitivity parameters. Inputs shall be subject to multi-level alarm verification. System shall be capable of reporting status and sensitivity of each device and vectoring this information to printer. System shall automatically identify any detector which becomes dirty (maintenance alert), prior to false alarming.
 - 3. System shall be supported by standby batteries. In event of loss of primary power, batteries shall support 60 hours of full supervisory operation followed by 15 minutes of alarm.

4. System shall be capable of nine levels of alarm prioritization, and allow control by event, and may include cross zoning, stepping, and/or logic statement inputs.
 5. Equipment shall be new and unused. Components and systems shall be designed for uninterrupted duty. Equipment, materials and accessories covered by these requirements shall be provided by single manufacturer, or if provided by different manufacturers, recognized as compatible by both manufacturers.
 6. Control equipment shall have transient protection devices to comply with UL 864 requirements.
 - a. Isolated Loop Circuit Protector (ILCP): Provide isolated loop circuit protection device on all fire alarm circuits which extend beyond building by either aerial, underground or other methods (walkways, bridges or other above ground connectors).
 - b. ILCP shall be located as close as practical to point at which circuits leave or enter building. Grounding conductor shall be No. 12 AWG wire having maximum length of 28 feet and connected to unified ground per NEC.
 7. Circuiting Guidelines. Each initiating device and indicating circuit shall be electronically supervised and individually addressable. Wiring shall match existing conventions as follows:
 - a. Individual Zone Addressable Modules shall be used to supervise and monitor waterflow, tamper, and status conditions from any related systems or devices.
 - b. Zone Addressable Control Modules and/or programmable relays shall provide auxiliary control functions.
 - c. Addressable loop wiring shall support all devices shown and allow for minimum of 25 percent spare capacity, and be wired in Class A, Style 7 fashion, with circuit isolation by floor and every 18 devices.
 - d. Entire system shall allow minimum of 25 percent spare capacity. This shall apply to all aspects of system including CPU, cabinets, power supplies, amplifiers and batteries.
 - e. Conventional Visual Appliance Circuits shall operate devices shown plus 25 percent spare capacity, and be wired in a Class A, Style Z fashion.
- D. Fire Alarm Control Panel:
1. Provide a Fire Alarm Control System. System shall consist of the required Fire Alarm control and remote nodes, each sized to support a minimum of 1000 analog points, expandable to 2500 points. Panels shall be provided with programmable soft switches and associated LED's for panel silence, alarm silence, system reset and drill. Provide lamp test button. Provide individual LED's for power-on, common alarm, supervisory, fault. Adjacent to the fire control panel, provide passive graphic map depicting architectural layout of building with stairwells, elevators, major corridors and egress points shown.
 2. Provide each panel with integral power supplies, amplifiers, addressable loop interface cards and standby batteries sized to serve building and/or space as shown. Panel shall have following functions:
 - a. Monitor all initiating devices, report event to fire alarm network, annunciate alarmed device and its' location, capture elevators, conduct smoke control functions, and initiate audio/visual evacuation signaling and control sequences as described herein.
 - b. Conduct municipal and off-site notification from main network panel as described herein.
 - c. Initiating devices shall respond with their condition. Control relays shall

be individually addressable by system to respond automatically in event of an alarm of related sensors. Manual override of control sequences and status feedback points shall be individually addressable.

3. Operator Controls: The control panel shall include an operator interface module consisting of 180 character backlit LCD display to display system wide alarm, trouble and supervisory conditions. Provide full system control from Fire Command Center, as well as control switches for status message scrolling, event acknowledgment, System Reset, and Alarm Silence. Display shall have LED's to indicate Power On, Fire Alarm, Supervisory, Trouble and Alarm Silenced status.
 4. Addressable Loop Interface: Provide addressable loop interface card for each floor in each building. Each interface card shall be integral to network panel and support digital communications. Each circuit shall support a total circuit capacity of up to 250 analog/addressable detectors and wiring of twisted unshielded pair with distances of up to 12,500 feet.
 5. Auxiliary Control / Annunciation: Provide required auxiliary switch and LED modules for discreet LED annunciation, zone disconnect, HVAC override, or related monitoring and control functions integral to each FACP. As a minimum, provide a minimum of 64 Auxiliary Override and Audio Control switches with status LED's and 8 HOA switches with corresponding status inputs and LED indicators for auxiliary functions, or as required. These are intended for use by Fire Department during events, or by authorized personnel during testing periods. Keypad entered commands for these functions shall not be acceptable
 6. Field Power Supplies: Provide Field power supplies with 24VDC operating and NAC Circuits for Visual signals, 6 amps minimum. Each power supply module shall have 4 dedicated Class A NAC outputs rated at 3 amps each and charging circuit that will support up to 12AH batteries. Provide necessary interface to synchronize all power supplies together and provide each power supply with independent monitor module for trouble supervision. Field Power Supplies shall be located on Floor/Section which they serve.
 7. Provide hard copy printout of system program to be maintained on site.
- E. Remote LCD Annunciator.
1. Each annunciator shall contain a supervised; back lit, liquid crystal with a minimum of 8 lines with 21 characters per line. Where required, the annunciator shall include additional zonal annunciation and manual control without additional enclosures. The annunciator shall support full ability to serve as the operating interface to the system and shall include the following features; Matched appearance with other system displays
- F. Intelligent System Devices:
1. Provide intelligent analog addressable devices where shown and required. Analog devices shall utilize dual multi-color red/ green LED indicator which shall flash green to denote normal active communication and light red steadily to denote alarm condition. Devices shall be interchangeable with twist-lock bases that support discreet address-setting rotary decade switches. Each base shall support remote LED output, fault isolation circuitry, auxiliary relay contact, or sounder base with integral Piezo horn were such functions are required. Provide wire guards or other physical protection devices as shown on contract documents.

2. Provide analog/addressable combination photoelectric smoke and carbon monoxide (CO) detectors at the locations shown on the Contract Drawings. The combination smoke and CO detector shall provide two independent signals (smoke & CO) to the control panel for programming system responses. When mounted in a sounder base, the detector shall be capable of initiating a temporal 3-3-3 when smoke is detected or temporal 4-4-4-4 when CO is detected. Detectors that transmit a common signal to the control panel for both smoke and CO alarms shall not be considered as equals. The detector shall be listed under standards UL-268 and UL-2075. Each smoke detector shall be individually programmable to operate at any one of five (5) sensitivity settings. The detector shall also store pre-alarm and alternate pre-alarm sensitivity settings. Pre alarm sensitivity values shall be configurable in 5% increments of the alarm and alternate alarm sensitivity settings respectively. The detector shall be able to differentiate between a long term drift above the pre alarm threshold and fast rise above the threshold. The detector shall monitor the sensitivity of the smoke sensor. If the sensitivity shifts outside the UL limits, a trouble signal shall be sent to the panel. It shall be possible to automatically change the sensitivity of individual intelligent addressable smoke detectors for day and night (alternate) periods. Each detector shall utilize an environmental compensation algorithm that shall automatically adjust for background environmental conditions such as dust, temperature, and pressure. The detector shall provide a maintenance alert signal when 80% (dirty) of the available compensation range has been used. The detector shall provide a dirty fault signal when 100% or greater compensation has been used. The smoke chamber shall be UL listed for field replacement. The electro-chemical CO sensor shall generate a CO alarm in compliance with UL-2034 requirements. The sensor shall have a nominal six-year life. When the sensor approaches the end of its useful life, it shall transmit a maintenance condition to the control panel, indicating the CO sensor board replacement is required. Only when the sensor is no longer operational shall a trouble condition be sent to the control panel. Sensors that transmit a common trouble indication for both sensor end-of-life and other causes of detector trouble shall not be considered as equal. Performing a "sensitivity" check from the panel shall report the approximate number months of CO sensor life remaining. Placing the CO detector in test mode shall facilitate the use of direct injection of small quantities of CO to check detector functionality. The CO sensor board shall be UL listed as field replaceable. Replacement of the CO sensor shall not require any field calibration.
3. Photoelectric Smoke Detector: Provide analog addressable photoelectric smoke detectors with adjustable sensitivity range from 0.2 to 3.7 percent obscuration where shown and required. Detectors shall provide complete analog features including alarm verification, environmental compensation, and multi-stage operation, were required.
4. Analog Heat Detectors: Provide Analog Heat Detectors. Analog heat detectors shall be field selectable for fixed temperature rating of 135 or 190 degrees, rate of rise operation of 15 degrees/minute, and will also include a low temperature warning (Supervisory condition) when ambient temperature reaches 40 degrees F. Where otherwise required, provide conventional fixed temperature, weatherproof or explosion proof heat detectors in lieu of analog heat detectors. Conventional device shall be individually addressable via intelligent addressable module which shall be installed in heated, ventilated location.
5. Analog Duct Smoke Detector: Provide analog photoelectric duct-mounted smoke detectors mounted in air ducts where shown and required. Duct detectors shall be programmed for alarm event sequencing or required by AHJ. Each detector

shall be supplied with duct-mount housing, remote indicator/test station and sampling tubes sized according to duct width. Provide necessary auxiliary relay outputs via addressable relay control modules with each detector in order to ensure required HVAC control, override and status reporting functions.

6. Intelligent Manual Pull Stations: Provide intelligent addressable manual stations where shown. Station shall be double action with screw terminals, toggle switch, and integral addressable electronics w status LED. Station shall be constructed of red Lexan with white raised letters and key reset switch. Station shall be keyed alike to FACP. Where ambient conditions preclude use of addressable devices, conventional weatherproof pull stations shall be used. Each conventional device shall be individually addressable via intelligent addressable module which shall be installed in heated, ventilated location.
 - a. Provide tamperproof clear Lexan covers with red frame and spacer, and audible trouble alarm, Stopper II or equal where shown.
7. Monitor Module: Provide Zone Addressable input Modules to enable monitoring and supervision of related systems and devices via SLC addressable loop.
8. Relay Module: Provide Addressable Relay to provide supervised control of auxiliary circuits (AHU's, door holders, etc.) via SLC addressable loop. Relay shall provide supervised output rated for 3 amps @ 30VDC or .5 amps at 120VAC. Where current exceeds limitations, provide isolation relay (PAM-1 or equal) rated for required load.
9. Isolation Modules: Where additional circuit isolation is required beyond isolation of the addressable loop interface, provide field-mounted Isolator Modules every 20 devices to protect circuit integrity in event of a wiring fault and ensure Style 6 wiring conventions.
10. Drill Switch: Provide a two position keyed Drill switch with addressable monitor module located as shown on contract drawings. Switch shall be fully programmable to initiate a drill of programmed areas with-out transmitting Municipal Signal. Restoration of key switch to "normal" shall return FACP and associated control equipment to normal with no other user interface to system.

G. Notification Appliances:

1. Provide flush mounted combination Audio/Visual signaling appliances. Stand-alone devices may be used to augment combination units when necessary. Provide surface mount back boxes and alternate outdoor-rated appliances where ambient conditions dictate. Provide wire guards or other physical protection devices as shown on contract documents.
2. Provide synchronized xenon strobes in compliance with NFPA 72, and rated per UL 1971 testing criteria. Strobes shall have effective intensity field selectable by installer in the range of 15CD to 115 CD.
3. Provide audible detector mounting bases suitable for mounting on a 1-gang, 3½ or 4 inch octagon box and 4 inch square box at the locations shown on the Contract Drawings. The bases shall utilize a twist-lock design and provide screw terminals for all field wiring connections. Removal of the respective detector shall not affect communications with other detectors. The audible base shall support

all detector types and shall be capable of single or group operation. The audible base shall emit a temporal 3-3-3 fire alarm tone when smoke or heat has been detected. The audible base shall emit a temporal 4-4-4-4 CO alarm tone when CO has been detected. The outputs shall be configurable for low or high output by moving a reversible jumper. The system shall be UL2017 listed for dual signaling for this purpose. The audible bases shall provide a UL-268 reverberant room sound output of 90.8 dBA at 10ft (3m) for temporal 3-3-3 fire alarm and 84.1 dBA at 10 ft.(3m) for temporal 4-4-4-4 CO alarm.

H. System Accessories:

1. Municipal Connection: Provide one (1) telephone dialer/digital Communicator unit for off-site transmission of supervisory signals. Provide the cost for monitoring at a UL listed central station for a period of one year.
2. Sprinkler System Devices: Coordinate following to ensure that required installation and wiring of waterflow and tamper switches is accomplished in manner that will result in complete operable and tested sprinkler system. Each device shall be monitored as separate and distinct point.
 - a. Waterflow shall activate alarm sequence.
 - b. Tamper switches shall activate supervisory condition.
3. Terminal Cabinets: Provide fire alarm terminal cabinets where necessary. Cabinets shall have removable hinged cover with key lock and red finish and are intended to house analog/addressable modules and facilitate filed wiring junctions.
4. Remote Alarm Indicators: Provide remote LED indicators for sensors located behind locked doors. Provide permanent label on each indicator identifying device type and actual location.
5. Auxiliary Power Supplies: Provide distributed network power supplies as required. Power supplies shall communicate directly to main Fire Alarm System via SLC communications to support network-based synchronization, and supervision of each panel for ground fault, loss of AC power and Battery Failure. Each notification circuit served shall be individually supervised via on-board circuitry.
6. Door Holders: Install flush, surface or floor-mounted 24VDC magnetic door holders where shown and required. Door holders will not be required to operate under standby power, following 30 second delay upon loss of primary AC power.

I. Installation:

1. Installation shall be supervised and tested by system supplier. Work shall be performed by skilled technicians under direction of experienced engineers, all of whom are properly trained and qualified.

J. Wiring:

1. Wiring for system shall be in accordance with Articles 760, 725, and 800 of National Electrical Code and local electrical codes. Cable shall be installed in conduit in accordance with manufacturer's instructions, with outgoing and return loops physically separated in accordance with applicable codes.

2. Provide complete wiring and conduit between all equipment. Devices shall be mounted upon and splices made in UL listed boxes. Wiring splices and transposing or changing of colors will not be permitted.
3. Junction boxes shall be painted red and labeled as 'Fire Alarm System' with decal or approved markings.
4. Fire Alarm control systems and equipment shall be connected to separate dedicated branch circuits, sized as required for proper service. Circuits shall be labeled 'FIRE ALARM'.

K. Final Tests, Records and Warranty:

1. Perform complete final test indicating proper functioning of system in accordance with all applicable codes and standards. Furnish copies of completed test report, as-built documentation and Record of Completion in accordance with NFPA 72 guideline to Owner and Architect for record purposes.
2. System test shall be conducted by UL certified testing company in accordance with UL guidelines and NFPA standards. Each and every device shall be tested in accordance with Manufacturer's recommendations.
3. Provide final test report and Record of Completion indicating proper functioning of the system and conformance to specifications. Test and Certificate of Completion shall be performed by factory-trained qualified technicians employed by Testing Contractor. Each and every device shall be tested, and standalone operation of remote panels shall be verified.
4. Final testing, certification and documentation shall be performed by same company that shall hold and execute Test and Inspection Contract.
5. In addition to pre-acceptance test, provide for complete and final Fire Department Acceptance Testing in accordance with requirements of Authority Having Jurisdiction and applicable codes.
6. Provide a 3 year warranty from date of final acceptance on all equipment. Labor on installation shall be guaranteed for a period of 1 year. Provide warranty documentation in the submittal.
7. Guarantee all raceways and wiring to be free from inherent mechanical or electrical defects for one year from the date of final acceptance of system.

L. Annual Testing and Support Contracts:

1. Include as part of base bid cost of Test and Inspection contract which will be in effect for 1 Year.
2. Contract shall allow for quarterly tests according to UL, NFPA and local requirements. In addition to required testing and inspections, contract shall include cleaning and sensitivity test of each system detector following first year.
3. Upon expiration of warranty period and initial test and inspection contract, contract shall be renewable upon its expiration at discretion of Building Owner.

- M. Training:
1. Provide services of manufacturer's representative-for an unlimited period, during normal business hours, to instruct owner's designated personnel and fire department response teams on operation of system.
- N. Spare Equipment:
1. Provide system spare devices as follows:
 - a. Manual stations - quantity of 3.
 - b. Smoke detectors with bases - quantity of 5.
 - c. Heat detectors with bases- quantity of 2.
 - d. Strobe only units - quantity of 2.
 - e. Duct smoke detector head and housing - quantity of 2.
 - f. Addressable contact monitor modules - quantity of 2.
 - g. Addressable relay modules - quantity of 2.

2.9 ACCESS PANELS

- A. Provide access panels for access to concealed junction boxes and to other concealed parts of system that require accessibility for operation and maintenance. In general, electrical work shall be laid out so access panels are not required.
- B. Access panels shall be located in a workmanlike manner in closets, storage rooms, and/or other non-public areas, positioned so that junction can be easily reached and size shall be sufficient for purpose (minimum size 12" x 16"). When access panels are required in corridors, lobbies, or other habitable areas, they shall be located as directed.
- C. Access panels shall be prime-painted and equipped with screwdriver operated cam locks.
- D. Acceptable Manufacturers:
1. Inland Steel Products Company – Milcor
 2. Miami Carey
 3. Walsh-Hannon-Gladwin, Inc. – Way Locator
 4. Specific Types:
 - a. Acoustical Tile Ceiling "Milcor Type AT"
 - b. Plastered Surfaces "Milcor Type K"
 - c. Masonry Construction "Milcor Type M"
 - d. Drywall Construction "Milcor Type DW"
- E. Furnish access panel Shop Drawings.

PART 3 EXECUTION

3.1 BASIC REQUIREMENTS

- A. Adhere to best industry practice and the following:
1. All work shall be concealed.

2. Route circuitry runs embedded in concrete to coordinate with structural requirements.
3. Equip each raceway intended for the future installation of wire or cable with a nylon pulling cord 3/16" in diameter and clearly identify both ends of the raceway.
4. Provide all outlet boxes, junction boxes, and pull boxes for proper wire pulling and device installation. Include those omitted from the Contract Drawings due to symbolic methods of notation.
5. Provide all sleeves through fireproof and waterproof slabs, walls, etc., required for electric work.
 - a. Provide waterproof sealing for the sleeves through waterproof slabs, walls, etc.
 - b. Provide fireproof sealing for the sleeves through fireproof walls, slabs, etc.
 - c. Provide fireproof sealing for the openings in fireproof walls, slabs, etc., resulting from removal of existing electrical sleeves, conduits, poke-thru's etc.
6. No splicing of wires will be permitted in Fire Alarm System.
7. Bundle wiring passing through pull boxes and panelboards in a neat and orderly manner.
8. Turn branch circuits and auxiliary system wiring out of wiring gutters at 90 degrees to circuit breakers and terminal lugs.
9. All panelboards shall be labeled in accordance with NFPA 70 Article 408.

3.2 TESTING REQUIREMENTS & INSTRUCTIONS

- A. The Electrical Subcontractor shall provide supervision, labor, materials, tools, test instruments and all other equipment or services and expenses required to test, adjust, set, calibrate, and operationally check work and components of the electrical systems and circuitry throughout Division 26 work.
- B. The Electrical Subcontractor shall pay for all tests specified in Division 26, including expenses incident to retests occasioned by defects and failures of equipment to meet Specifications, at no additional cost to the Owner. Any defects or deficiencies discovered in any of the Electrical work shall be corrected.
 1. The Electrical Subcontractor shall:
 - a. Replace wiring and equipment found defective (defined as failing to meet specified requirements) at no additional cost to the Owner.
 - b. Submit three (3) copies of test results to the Engineer.
 2. Do not void equipment warranties or guarantees by testing and checkout work. Checks and tests shall be supplemental to and compatible with the Manufacturer's installation instructions. Where deviations are apparent, obtain the Manufacturer's approved review of procedures prior to testing. Where any repairs, modifications, adjustments, tests or checks are to be made, the Contractor shall contact the Engineer to determine if the work should be performed by or with the Manufacturer's Representative.

3. Tests are to:
- a. Provide initial equipment/system acceptance.
 - b. Provide recorded data for future routine maintenance and troubleshooting.
 - c. Provide assurance that each system component is installed satisfactorily and can be expected to perform, and continue to perform its specified function with reasonable reliability throughout the life of the facility.
 - 1) At any stage of construction and when observed, any electrical equipment or system determined to be damaged, or faulty, is to be reported to the Engineer. Corrective action by the Contractor requires prior Engineer approval, retesting, and inspection.
 - 2) Prior to testing and start-up, equipment and wiring shall be properly and permanently identified with nameplates, and other identification as specified in Section 3.7. Check and tighten terminals and connection points, remove shipping blocks and thoroughly clean equipment, repair damaged or scratched finishes, inspect for broken and missing parts and review and collect Manufacturer's Drawings and instructions for delivery to the Engineer. Make routine checks and tests as the job progresses to ensure that wiring and equipment is properly installed.
 - 3) Testing and checkout work is to be performed with fully qualified personnel skilled in the particular tests being conducted. Personnel are to have at least five (5) years of experience with tests of same type and size as specified.
 - 4) Inspections and tests shall be in accordance with the following applicable codes and standards as amended to date, unless otherwise specified.
 - a) National Electrical Manufacturer's Association – NEMA.
 - b) American Society for Testing and Materials _ ASTM.
 - c) Institute of Electrical and Electronic Engineers – IEEE.
 - d) National Electrical Testing Association – NETA.
 - e) American National Standards Institute – ANSI.
 - f) C2: National Electrical Safety Code.
 - g) Z244-1: American National Standard for Personnel Protection.
 - h) Insulated Cable Engineers Association – ICEA.
 - i) Association of Edison Illuminating Companies – AEIC.
 - j) Occupational Safety and Health Administration – OSHA.
 - k) OSHA Part 1910; Subpart S, 1910.308.
 - l) OSHA Part 1926; Subpart V, 1926.950 through 1926.960.
 - m) National Fire Protection Association – NFPA.
 - n) 70B: Electrical Equipment Maintenance.
 - o) 70E: Electrical Safety Requirements for Employer Workplaces.
 - p) 70: National Electrical Code.
 - q) 78: Lightning Protection Code.
 - r) 101: Life Safety Code.
 - s) Inspections and tests shall utilize the following references:
 - t) Contract Drawings and Specifications.
 - u) Contractor's Short Circuit and Construction Study, in accordance with Section 26 00 00D.
 - v) Manufacturer's printed test procedures for respective equipment.

4. Test Equipment:
 - a. Test equipment used by the Contractor is to be inspected and calibrated.
 - b. Perform calibration and setting checks with calibrated test instruments of at least twice that of the accuracy of the equipment, device, relay or meter under test. Dated calibration labels shall be visible on test equipment. Calibrations over six (6) months old are not acceptable on field test instruments. Inspect test instruments for proper operation prior to proceeding with the tests. Record serial and model numbers of the instruments used on the test forms.

5. Test Procedures:
 - a. The Electrical Subcontractor is responsible for the preparation of the procedures and schedules for the work specified herein. This work is to be coordinated and compatible with both the work and schedule of the other crafts. Sequence the tests and checks so that the equipment can be energized immediately after the completion of the application tests.
 - b. Submit proposed testing and checkout forms. The procedures shall provide specific instructions for the checking and testing of each electrical component of each system. Schedule tests and inspections as the job progresses. Test procedures submitted shall include job safety rules.
 - c. After each electrical system installation is complete, perform the tests to determine that the entire system is in proper working order and in accordance with applicable codes, Manufacturer's instructions, Drawings, and Specifications. Tests are in addition to shop tests of individual items at the Manufacturer's plant. Perform insulation and ground resistance tests before operating tests.
 - d. Perform insulation tests on electrical equipment, apparatus, cables, and similar electrical equipment, at the following items and conditions:
 - e. Prior to energization and/or placing into service.
 - f. When damage to the insulation is suspected or known to exist.
 - g. After repairs or modifications to the equipment affecting the insulation.
 - h. Where lightning or other surge conditions are known to have existed on the circuit.
 - i. Make openings in circuits for test instruments and place and connect instruments, equipment, and devices, required for the tests. Upon completion of tests, remove instruments and instrument connections and restore circuits to permanent condition.
 - j. List each circuit and measured resistance as test data. Maintain record of insulation resistance values. Identify conductor, or equipment, date that value was taken and resistance value. Arrange information in tabular form and submit to Engineer.
 - k. Report inspections, tests, and calibrations in writing on Engineer approved reports/forms. The recorded data form shall have the signatures of the persons conducting the tests, authorized witnesses and the Engineer. The forms shall serve as the test and inspection checklist.
 - l. When the electrical tests and inspections specified or required within Division 26 are completed and results reported, reviewed, and approved by the Engineer, the Contractor may consider that portion of the electrical equipment system or installation electrically complete. The Contractor will then affix appropriate, approved, and dated completion or calibration labels to the tested equipment and notify the Engineer of electrical completion. If the Engineer finds completed work unacceptable, he will notify the Contractor in writing of the unfinished or

deficient work, with the reason for his rejection, to be corrected by the Contractor. The Contractor will notify the Engineer in writing when exceptions have been corrected. The Contractor will prepare a "Notification of Substantial Electrical Completion" for approval by the Engineer following Engineer's acceptance of electrical completion. If later in-service operation or further testing identified problems attributable to the Contractor, these will be corrected by the Contractor, at no additional cost to the Authority.

- C. Specific Tests: Perform the following specified tests. De-energize and isolate equipment and cable prior to performing the tests.
- D. Grounding Systems:
 - 1. Perform ground tests using a low resistance, null-balance type ground testing ohmmeter, with test lead resistance compensated for. Use the type of test instrument which compensates for potential and current rod resistances.
 - 2. Where ground test results identify the need for additional grounding conductors or rods that are not indicated or specified, design changes will be initiated to obtain the acceptable values. The Contractor is responsible for the proper installation of the grounding indicated and specified.
- E. Power Distribution System:
 - 1. The following systems shall adhere to the general requirements of this section in addition to complying with the specific test requirements outlined in the respective sections listed:
 - a. Fire Alarm System.
 - 2. Operating Instructions: Furnish operating instructions to Owner's designated representative with respect to operations, functions and maintenance procedures for equipment and systems installed. Cost of such instruction up to a full five (5) days of Electrical Subcontractor's time shall be included in contract. Cost of providing a Manufacturer's Representative at site for instructional purposes shall also be included.

3.3 BRANCH CIRCUITRY

- A. For all lighting and appliance branch circuitry, raceway sizes shall conform to industry standard maximum permissible occupancy requirements except where these are exceeded by other requirements specified elsewhere.
- B. Circuits shall be balanced on phases at their supply as evenly as possible.
- C. Feeder connections shall be in the phase rotation which establishes proper operation for all equipment supplied.
- D. Reduced size conductors indicated for any feeders shall be taken as their grounding conductors.
- E. Feeders consisting of multiple cables and raceways shall be arranged such that each raceway of the feeder contains one (1) cable for each leg and one (1) neutral cable, if any.
- F. For circuitry indicated as being protected at 20 Amps or less, abide by the following:

1. All 20 amp, 120/208 volt, 3-phase, 4-wire combined branch circuit homeruns shall be provided with a #8 AWG neutral conductor.
 2. Minimum conductor size shall be No. 12 AWG copper.
 3. Conductors operating at 120 volts extending in excess of 100 ft. or at 277 volts extending in excess of 200 ft., or the last outlet or fixture tap shall be No. 10 AWG copper throughout.
 4. Lighting fixtures and receptacles shall not be connected to the same circuit.
 5. Circuits shall be balanced on phases at their supply point as evenly as possible.
- G. Type MC Cable Installation:
1. Where cable is permitted under the products section, the installation of same shall be done in accordance with code and the following:
 - a. Cable shall be supported in accordance with code. Tie wire is not an acceptable means of support. Cable supports such as Caddy WMX-6, MX-3, and clamps such as Caddy 449 shall be used. Where cables are supported by the structure and only need securing in place, then ty-raps will be acceptable. Ty-raps are not acceptable as a means of support. All fittings, hangers, and clamps for support and termination of cables shall be of type specifically designed for use with cable, i.e., romex connectors not acceptable.
 - b. Armor of cable shall be removed with rotary cutter device equal to roto-split by Seatek Co.; not with a hacksaw.
 - c. Use split "Insuliner" sleeves at terminations.

3.4 REQUIREMENTS GOVERNING ELECTRICAL WORK IN DAMP OR WET LOCATIONS

- A. Outlets and outlet size boxes shall be of galvanized cast ferrous metal only.
- B. The finish of threaded steel conduit shall be galvanized only.
- C. Wires for pulling into raceways for lighting and appliance branch circuitry shall be limited to "THWN".
- D. Wires for pulling into raceways for feeders shall be limited to "XHHW".
- E. Plates for toggle switches and receptacles shall have gasketed snap shut covers suitable for wet locations while in use.
- F. Final connections of flexible conduit shall be neoprene sheathed.
- G. Apply one (1) layer of half looped plastic electric insulating tape over wire nuts used for joining the conductors of wires.
- H. Enclosures, junction boxes, pull boxes, cabinets, cabinet trims, wiring troughs and the like, shall be fabricated of galvanized sheet metal, shall conform to the following:
 1. They shall be constructed with continuously welded joints and seams.

2. Their edges and weld spots shall be factory treated with cold galvanizing compound.
3. Their connection to circuitry shall be by means of watertight hub connectors with sealing rings.
- I. Enclosures for individually mounted switching and overcurrent devices shall be NEMA Class IV weatherproof construction.
- J. The covers, doors and plates and trims used in conjunction with all enclosures, pull boxes, outlet boxes, junction boxes, cabinets and the like shall be equipped with gaskets.
- K. Panels shall be equipped with doors without exception.
- L. The following shall be interpreted as damp or wet locations within building confines:
 1. Spaces where any designations indicating weatherproof (WP) or vapor proof appear on the Contract Drawings.
 2. Below waterproofing in slabs applied directly on grade.
 3. Spaces defined as wet or damp locations by Article 100 of the National Electric Code.

3.5 REQUIREMENTS GOVERNING ELECTRIC WORK IN AIR HANDLING SPACES

- A. Within air handling plenums:
 1. Abide by the requirements specified for electric work in damp locations within building confines.
 2. All cabling and electrical equipment installed within plenums shall be listed for plenum use.
 3. Exclude the installation of type NM or NMC cable.
- B. In spaces within suspended ceilings used for air handling purposes, abide by the requirements specified for normal electric work conditions except:
 1. Lighting fixtures recessed into the ceilings shall be certified as being suitable for this purpose.

3.6 IDENTIFICATION AND TAGGING

- A. Identify individually:
 1. Each panelboard.
 2. Each switch and circuit breaker.
 3. Each feeder, wire or cable or all systems.
 4. Each end of nylon pullwire in empty conduit.
- B. Each wire or cable in a feeder shall be identified at its terminal points of connection and in each pullbox, junction box and panel gutter through which it passes.

- C. The nomenclature used to identify panelboards or load center shall designate the numbers assigned to them.
- D. The nomenclature used to identify switches or circuit breakers shall:
 - 1. Where they disconnect mains or services designate this fact.
 - 2. Where they control feeders, designate the feeder number and the name of the load supplied.
 - 3. Where they control lighting and appliance branch circuitry, designate the name of the space and the load supplied.
- E. The nomenclature used to identify feeder wires and cables shall designate the feeder number.
- F. Identification for panelboards or load centers shall be by means of engraved Lamacoid nameplates showing 1/4" high white lettering on a black background fastened to the outside face of the front.
- G. Identification for switches or circuit breakers shall be by means of the following:
 - 1. Where individually enclosed – engraved Lamacoid nameplates showing 1/8" high white lettering on a black background fastened on the outside front face of the enclosure.
 - 2. Where in panelboards or load centers without doors – same as for individually enclosed.
 - 3. Where in panelboards or load centers with doors – typewritten directories mounted behind transparent plastic covers, in metal frames fastened on the inside face of the doors.
- H. Identification for wires and cables shall be by means of wrap around "brady" type labels.
- I. Device plates for local toggle switches, toggle switch type motor starters, pilot lights and the like, whose function is not readily apparent shall be engraved with 1/8" high letters suitably describing the equipment controlled or indicated.
- J. Phase identification letters shall be stamped into the metal of the bus bars of each phase of the main busses of each switchboard and each panelboard. The letters shall be visible from at least one (1) "normal posture" location without having to demount any current carrying or supporting elements.
- K. Provide a sign at the service entrance equipment room indicating the type and location of all on-site emergency or standby power sources.
- L. Identify each outlet box, junction box, and cabinet used in conjunction with empty raceway for wires of a future system by means of indelible markings on the inside denoting the system.
- M. Prior to installing identifying tags and nameplates, submit their nomenclature for approval. Conform to all revisions issued by the Architect.

3.7 LIMITING NOISE PRODUCED BY ELECTRICAL INSTALLATION

- A. Perform the following work in accordance with field instructions issued by the Architect to assure that minimal noise is produced by electrical installations due to equipment furnished as part of the Electrical work.
- B. Check and tighten the fastenings of sheet metal plates, covers, doors and trims used in the enclosures of electrical equipment.
- C. Remove and replace any individual device containing one or more magnetic flux path metallic cores (e.g., discharge lamp ballast, transformer, reactor, dimmer, solenoid) which is found to have a noise output exceeding that of other identical devices installed at the project.

3.8 SUPPORTS AND FASTENINGS

- A. Support work in accordance with best industry standards, Local Electric Code and the following:
 - 1. Include supporting frames or racks for equipment, intended for vertical surface mounting, which is required in a freestanding position.
 - 2. Supporting frames or racks shall be of standard angle, standard channel or specialty support system steel members. They shall be rigidly bolted or welded together and adequately braces to form a substantial structure. Racks shall be of ample size to assure a workmanlike arrangement of all equipment mounted on them.
 - 3. No work intended for exposed installation shall be mounted directly on any building surface. In such locations, flat bar members or spaces shall be used to create a minimum of ¼" air space between the building surfaces and the work. Provide ¾" thick exterior grade plywood painted with two (2) coats of fire-retardant gray paint for mounting of panelboards.
 - 4. Nothing (including outlet, pull and junction boxes and fittings) shall depend on electric conduits, raceways or cables for support.
 - 5. Nothing shall rest on, or depend for support on, suspended ceiling media.
 - 6. Support less than 2" trade size, vertically run, conduits at intervals no greater than 8'. Support such conduits, 2-1/2" trade size or larger, at intervals no greater than they story height, or 15', whichever is smaller.
 - 7. Where they are not embedded in concrete, support less than 1" trade size, horizontally run, conduits at intervals no greater than 7'. Support such conduits, 1" trade size or larger, at intervals no greater than 10'.
 - 8. Support all lighting fixtures directly from structural slab, intermediate decking or framing member as directed by the Architect. No light fixtures shall be supported directly from the roof deck.
 - 9. Where fixtures and ceilings are such as to require fixture support from ceiling openings frames, include in the electric work the members necessary to tie back the ceiling opening frames to ceiling suspension members or slabs so as to provide actual support for the fixtures noted above.

10. Support all runs of conduit and/or circuitry directly from structural slabs, intermediate decking or framing members.
11. Fasten electric work to building structure in accordance with the best industry practice.
12. Floor mounted equipment shall not be held in place solely by its own dead weight. Include floor anchor fastenings in all cases.
13. For items which are shown as being ceiling mounted at locations where fastenings to the building construction element above is not possible, provide suitably auxiliary channel or angle iron bridging tying to building structural elements.
14. As a minimum procedure, where weight applied to the attachment points is 100 lbs. or less, fasten to concrete and solid masonry with bolts and expansion shields.
15. As a minimum procedure, where weight applied to building attachment points exceed 100 lbs., but is 300 lbs. or less, conform to the following:
 - a. At field poured concrete slabs, utilize inserts with 20' minimum length slip-through steel rods, set transverse to reinforcing steel.

3.9 SPLICING AND TERMINATING WIRES AND CABLES

- A. Maintain all splices and joints in removable cover boxes or cabinets where they may be easily inspected.
- B. Locate each completed conductor splice or joint in the outlet box, junction box, or pull box containing it, so that it is accessible from the removal cover side of the box.
- C. Join solid conductors No. 8 AWG and smaller by securely twisting them together and soldering, or by using insulated coiled steel spring "wire nut" type connectors. Exclude "wire nuts" employing non-expandable springs. Terminate conductors No. 8 AWG and smaller by means of a neat and fast holding application of the conductors directly to the binding screws or terminals of the equipment or devices to be connected.
- D. Join, tap and terminate standard conductors No. 6 AWG and larger by means of solder sleeves, taps, and lugs with applied solder or by means of bolted saddle type or pressure indent type connectors, taps and lugs. Exclude connectors and lugs of the types which apply set screws directly to conductors. Where equipment or devices are equipped with set screw type terminals which are impossible to change, replace the factory supplied set screws with a type having a ball bearing tip. Apply pressure indent type connectors, taps and lugs utilizing tools manufactured specifically for the purpose and having features preventing their release until the full pressure has been exerted on the lug or connector.
- E. Except where wire nuts are used, build up insulation over conductor joints to a value, equal both in thickness and dielectric strength, to that of the factory applied conductor insulation. Insulation of conductor taps and joints shall be by means of half-lapped layers of rubber tape, with an outer layer of friction tape; by means of half-lapped layers of approved plastic electric insulating tape; or by a means of split insulating casings manufactured specifically to insulate the particular connector and conductor, and fastened with stainless steel or non-metallic snaps or clips.

- F. Exclude splicing procedures for neutral conductors in lighting and appliance branch circuitry which utilize device terminals as the splicing points.
- G. Exclude joints or terminations utilizing solder in any conductors used for grounding or bonding purposes.
- H. Exclude all but solder or pressure indent type joints in conductors used for signaling or communication purposes.
- I. Lugs for conductors used to make phase leg connections on the line side of the main service overcurrent and switching device shall be of the limiter type.

3.10 PULLING WIRES INTO CONDUITS AND RACEWAYS

- A. Delay pulling wires or cables in until the project has progressed to a point when general construction procedures are not liable to injure wires and cables, and when moisture is excluded from raceways.
- B. Utilize nylon snakes or metallic fish tapes with ball type heads to set up for pulling. In raceways 2" trade size and larger, utilize a pulling assembly ahead of wires consisting of a suitable brush followed by a 3-1/2" diameter ball mandrel.
- C. Leave sufficient slack on all runs of wire and cable to permit the secure connection of devices and equipment.
- D. Include circular wedge-type cable supports for wires and cables at the top of any vertical raceway longer than 20 feet. Also include additional supports spaced at intervals which are no greater than 10'. Supports shall be located in accessible pull boxes. Supports shall be of a non-deteriorating insulating material manufactured specifically for the purpose.
- E. Pulling lubricants shall be used. They shall be products manufactured specifically for the purpose.
- F. Slack on wires and cables located in cabinets and pull boxes shall be formed and set in place in groupings corresponding to their occupancy of raceways. They shall also be arranged, with insulators and supports provided where necessary, such that cable shims or other such temporary expedients do not have to be left permanently in place to prevent the wires and cables from shifting when covers or trims are removed.

3.11 REQUIREMENTS FOR THE INSTALLATION OF JUNCTION BOXES, OUTLET BOXES AND PULL BOXES

- A. Flush wall-mounted outlet boxes shall not be set back to back but shall be offset at least 12" horizontally regardless of any indication on the Contract Drawings.
- B. Locate all boxes so that their removable covers are accessible without necessitating the removal of parts of permanent building structure, including piping, ductwork, and other permanent mechanical elements.
- C. In conjunction with concealed circuitry, abide by one of the following instructions (as may be applicable to the conditions) in order to assure the aforementioned accessibility. (Not required for circuitry concealed by removable suspended ceiling tiles.)
 - 1. For a small (outlet size) box on circuitry concealed in a partition or wall, locate box or fitting so that its removable cover side, (or the face of any applied raised

- cover) penetrates through to within 1/8" of the exposed surface of the building materials concealing the circuitry and apply a blank or device plate to suit the functional requirements.
2. For a large box on circuitry concealed in a partition, suspended ceiling, or wall, locate box totally hidden but with its removable cover directly behind an architectural access door or panel (included for the purpose, separate from the electric work) in the building construction which conceals the circuitry.
 3. For a small (outlet size) box on circuitry concealed above and intended as an outlet for a surface mounted lighting fixture or other such electrical item, locate box so that its removable cover side penetrates through to the exposed surface of the building materials concealing the circuitry. Arrange the mounting of the lighting fixture or other item so that it completely covers the opening in the building construction caused by the box.
 4. For a small (outlet size) box on circuitry concealed in a suspended ceiling, and intended as an outlet for a non-demountable type of recessed lighting fixtures or other such electrical items, locate box totally hidden but with its removable cover not more than 1' away from the building construction opening occupied by the demountable items.
- D. Apply junction and pull boxes in accordance with the following:
1. Include all pull boxes in long straight runs of raceway to assure that cables are not damaged when they are pulled in.
 2. Include junction and pull boxes to assure a neat and workmanlike installation of raceways.
 3. Include junction and pull boxes to fulfill requirements pertaining to the limitations to the number of bends permitted in raceway between cable access points, the accessibility of cable joints and splices, and the application of cable supports.
 4. Include all required junction and pull boxes regardless of indications on the Contract Drawings (which, due to symbolic methods of notation, may omit to show some of them).
- E. Apply outlet boxes in accordance with the following:
1. Unless noted below or otherwise specifically indicated, include a separate outlet box for each individual wiring device, lighting fixture and signal or communication system outlet component. Outlet boxes supplied attached to lighting fixtures shall not be used as replacements for the boxes specified herein.
 2. A continuous row of fixtures of the end-to-end channel type, designed for "through wiring", and wired in accordance with the specification hereinafter pertaining to circuitry through a series of lighting fixtures, may be supplied through a single outlet box.
 3. A series of separate fixtures, designed for "through wiring", spaced not more than 4' apart, and inter-connected with conduit or raceway and circuitry which is in accordance with the Specifications hereinafter pertaining to circuitry through a series of lighting fixtures, may be supplied through a single outlet box.

4. Connection to recessed ceiling fixtures supplied with pigtails may be arranged so that more than one (1), but not more than four (4) such fixtures are connected into a single outlet box. When adopting this procedure:
 - a. Utilize an outlet box no smaller than 5" square by 2-1/2" deep.
 - b. Allow no fixture to be supplied from an outlet box in another room.
 5. Multiple local switches indicated at a single location shall be gang-mounted in a single outlet box.
 6. Include all required outlet boxes regardless of indications on the Contract Drawings (which due to symbolic methods of notation, may omit to show some of them).
- F. Install junction boxes, pull boxes and outlet boxes in conjunction with concealed circuitry.
1. Exclude surface-mounted outlet boxes in conjunction with concealed circuitry.
 2. Exclude unused circuitry openings in junction and pull boxes. In larger boxes each such opening shall be closed with a galvanized sheet steel plate fastened with a continuous weld all around. In small outlet type boxes, utilize plugs as specified for such boxes.
 3. Close up all unused circuitry openings in outlet boxes. Unused openings in cast boxes shall be closed with approved cast metal threaded plugs. Unused openings in sheet metal boxes shall be closed with sheet metal knock-out plugs.
 4. Outlet boxes for switches shall be located at the strike side of doors. Indicate door swings are subject to field change. Outlet boxes shall be located on the basis of final door swing arrangements.
 5. Boxes and plaster covers for duplex receptacles shall be arranged for vertical mounting of the receptacle.
 6. Equip outlet boxes used for devices which are connected to wires of systems supplied by more than one set of voltage characteristics with barriers to separate the different systems.
- G. Barriers in junction and pull boxes of outlet size shall be of the same metal as the box.
1. Barriers in junction and pull boxes which are larger than outlet size shall be of the polyester resin fiberglass of adequate thickness for mechanical strength, but in no case less than 1/4" thick. Each barrier shall be mounted, without fastenings, between angle iron guides so that they may be readily removed.

3.12 LOCATING AND ROUTING OF CIRCUITRY

- A. In general, all circuitry shall be run concealed except that it shall be run exposed where the following conditions occur:
1. Horizontally at the ceiling of permanently unfinished spaces which are not assigned to mechanical or electrical equipment.
 2. Horizontally and vertically in mechanical equipment spaces.
 3. Horizontally and vertically in electric equipment rooms.

- B. Concealed circuitry shall be so located that building construction materials can be applied over its thickest elements without being subject to spalling or cracking.
- C. All circuitry and raceways shall not be run within slabs. If field conditions requires raceways to be embedded in field-poured structural building construction concrete fill or slab shall conform to the following:
 - 1. All proposed embedded raceways shall be indicated on plan and elevation and submitted to the Architect and Structural Engineer for review and written approval prior to installation. Any costs associated with the review and approval shall be borne by the Electrical Subcontractor.
 - 2. They shall be run "single layer" with their outside surface no closer than 1" to any surface of the structural concrete.
 - 3. They shall not be located in any configuration which places the outside surface of one closer than 3" to outside surface of another, except at tees, crosses or other single level wide angle junction points.
 - 4. Where crossovers or close grouping are unavoidable, circuitry shall be carefully field coordinated so as not to cause structural weakness.
 - 5. Where turned up or down into a wall or partition they shall, before entering same, be routed parallel for a long enough distance to assure that no relocation of the wall or partition will be necessary to conceal the required bend.
 - 6. They shall be routed in such a manner as to coordinate with the structural requirements of the building.
 - 7. They shall be routed in accordance with field instructions issued by the Architect where such instructions differ from Specifications set forth herein.
- D. Circuitry run exposed shall be routed parallel to building walls and column lines.
- E. Exposed circuitry located overhead shall be run in a completely accessible manner on the underside of all piping and ductwork.
- F. Circuitry run in suspended ceilings shall be routed parallel to building walls, column lines, etc.
- G. Circuitry shall be routed so as to prevent electric conductors from being subject to high ambient temperature. Minimum clearances from heated lines or surfaces shall be maintained as follows:
 - 1. Crossing where uninsulated: 3".
 - 2. Crossing where insulated: 1"
 - 3. Running parallel where uninsulated: 36".
 - 4. Running parallel where insulated: 6".
- H. Circuitry shall not be run in elevator shafts, hoistways, and the like. Where outlets for trail cables, pit lights, run be level lights, and the like, are involved, only the "final connection"

outlet boxes themselves shall be located within or open into, the confines of the shaft.

- I. Circuitry for miscellaneous systems indicated without notation as to location and routing shall be run as per the requirements and notations governing the adjacent light and power circuitry.

3.13 INSTALLING CIRCUITRY

- A. The outside surface of circuitry, which is to be embedded in cinder concrete, shall be coated with asphaltum paint.
- B. In runs of conduit or raceway including flexible limit the number of bends between cable access points to a total which does not exceed the maximum specified for the particular system. Where no such maximum is specified, limit the number to four (4) right angle bends or the equivalent thereof.
- C. In each conduit or raceway assigned for the future pulling in of wires, include a nylon drag cord. In raceways 2" trade size and larger, the cord shall be pulled in utilizing a suitable brush, followed by an 85% diameter ball mandrel ahead of the cord in the pulling assembly. In the event that obstructions are encountered, which will not permit the drag cord to be installed, the blocked section of raceway shall be replaced and any cutting and patching of the structure involved in such replacement shall be included as part of the electric work.
- D. Circuitry shall be arranged such that conductors of one feeder or circuitry carrying "going" current are not separated from conductors of the same feeder or circuitry carrying "return" current by any ferrous or other metal. Where not within raceways, all "going" and "return" current conductors of one feeder or circuit shall be laced together so as to minimize induction heating of adjacent metal components.
- E. Sleeves used where circuitry is to penetrate waterproof slabs, decks and walls, shall be of a type selected to suit the water condition encountered in the field.

END OF SECTION 26 00 00



STATE OF RHODE ISLAND AND PROVIDENCE PLANTATIONS
RHODE ISLAND JUDICIARY - FACILITIES AND OPERATIONS

250 BENEFIT STREET – ROOM 205
PROVIDENCE, RHODE ISLAND 02903
TEL: 401-222-6700
FAX: 401-222-4740

CRIMINAL BACKGROUND INVESTIGATION AUTHORIZATION, RELEASE AND DISCLAIMER

I, _____, hereby direct and authorize the Bureau of Criminal Identification of the Department of Attorney General for the State of Rhode Island to make available to the Rhode Island Administrative Office of State Courts any criminal record that the Bureau of Criminal Identification has on file in reference to me, and I further consent to the authentication of my identity through fingerprinting, or some other process that may be required to confirm my identity.

I understand that an investigative report may be generated on me from any source that may include information as to my criminal history from any criminal justice agency or court in any or all federal, state, city and county jurisdictions, including any state Department of Motor Vehicle/Drivers' license records, traffic citations and/or registrations.

I hereby waive and release any and all manner of actions, cause of actions, and demands of every kind, nature and description, arising from any release of criminal information and requests therefrom, whatsoever against the State of Rhode Island, the Rhode Island Administrative Office of State Courts, the Bureau of Criminal Identification, the Attorney General, and the employees of the Attorney General's Office, in both law and equity which I may now have or that may arise in the future.

Employee Name (Please Print)

Employee Signature

Maiden Name (If Applicable)

Date

Date of Birth

Employer/Company Name (If applicable)

Place of Birth

Social Security Number

Project Name: _____

Project # _____

Date of Bid/RFP Specifications _____

Sworn to before me in the City/Town of _____, State of Rhode Island, this _____ day of _____, 20____.

Commission expires on _____.

Notary Public (Print Name)

Notary Public (Signature)

Copy of valid photo identification with date of birth must be attached to all BCI Authorization Forms.

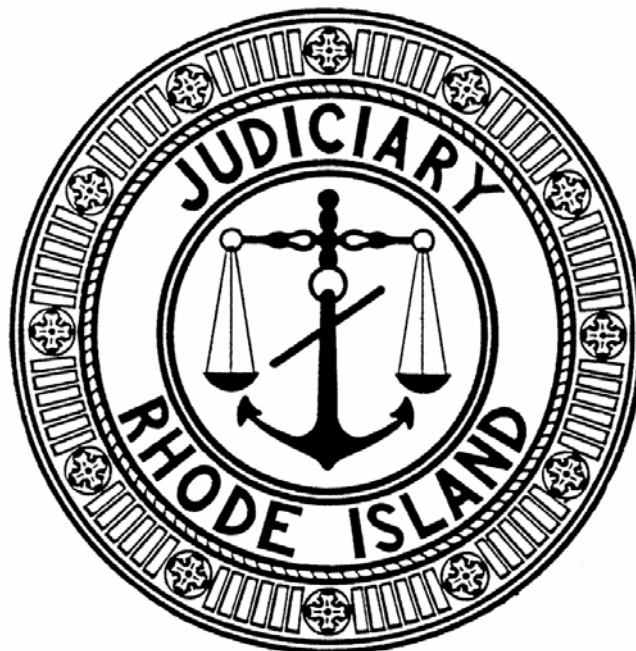

**JUDICIAL PURCHASING
RULES AND REGULATIONS**

TABLE OF CONTENTS

Article I.	Authority	4
Article II.	Purpose and Policy.....	4
Article III.	Scope.....	4
Article IV.	Participation in Other State Contracts and Use of Services.....	5
Article V.	Waivers/Deviations.....	5
Article VI.	Procurement Integrity	5
Article VII.	Access to Information.....	5
Article VIII.	Judicial Purchasing Committee and Judicial Purchasing Structure	6
Section 8.01	Judicial Purchasing Committee.....	6
A.	Responsibilities of the Judicial Purchasing Committee.....	6
B.	Meetings of the Judicial Purchasing Committee	6
C.	Judicial Purchasing Structure and Responsibilities	7
Section 8.02	Chief Purchasing Officer	7
Section 8.03	Judicial Purchasing Agent.....	8
Article IX.	Definitions.....	8
Article X.	Methods of Source Selection	9
Section 10.01	Master Price Agreement (MPA).....	9
Section 10.02	Competitive Sealed Bidding	9
A.	Standards and Specifications	10
B.	Solicitations.....	10
C.	Receipt of Offers.....	12
D.	Withdrawal or Correction of Offers.....	12
E.	Evaluation of Offers.....	13
F.	Awards	13
G.	Negotiations After Unsuccessful Competitive Sealed Bidding.....	14
H.	Protest Procedures.....	15
Section 10.03	Competitive Negotiations	16
A.	Content of Request for Proposal.....	16
B.	Procedure for Competitive Negotiations	17
Section 10.04	Non Competitive Negotiations	17

Section 10.05	Exceptions.....	17
A.	Emergency	18
B.	Sole source	18
C.	Professional, Technical and Consulting Assistance.....	19
D.	Small Purchases	19
E.	Informal Competitive Bids	19
F.	Direct Billing	20
Article XI.	Contractor Prequalification, Qualification and Solicitation.....	20
Section 11.01	Definitions.....	20
A.	Registered Suppliers	20
B.	Unregistered Suppliers.....	21
Section 11.02	Responsibilities of Bidders and Offerors	21
Section 11.03	Bidder Registration Form	22
Section 11.04	Bidder Registration Fee	22
Section 11.05	Vendor Information Files.....	22
A.	General.....	22
B.	Bidding History.....	23
C.	Performance History	23
Section 11.06	Prequalification of Contractors	23
Section 11.07	Construction Management	24
Section 11.08	Vendor Disqualification.....	24
A.	Rejection and Removal.....	25
B.	Debarment and Suspension from Bidders List	25
Section 11.09	Notification, Protest and Reconsideration	27
A.	Notice.....	27
B.	Protests.....	28
C.	Reconsideration.....	28
Section 11.10	Public Works Contracts	28
Article XII.	General Terms and Conditions of Purchase.....	28
Section 12.01	General Terms and Conditions	28
Section 12.02	Purchase Order Contracts	29

Article XIII.	Multi-Year Contracts	29
Article XIV.	Letter of Authorization	30
Section 14.01	Definition and Purpose	30
Section 14.02	Changes to Purchase Orders	31
Section 14.03	Suspension or Termination of Contract	31
A.	Suspension of a Contract by the Judiciary	31
B.	Termination of a Contract by the Judiciary	32
Article XV.	Presumption of Correctness and Finality of Determinations	33
Section 15.01	Decision Presumed To Be Correct.....	33
Section 15.02	Finality of Determinations	34
Article XVI.	Authority to Resolve Contract and Breach of Contract Controversies.....	34
Article XVII.	Dispute and Appeals Procedure	34
Article XVIII.	Records	35
Section 18.01	Report of Noncompetitive Negotiations and Small Purchases.....	35
Article XIX.	Grants.....	35
Section 19.01	Grants Not Considered Procurements.....	35
Section 19.02	Special Provisions and Requirements for Grants.....	36
A.	Contracting Authority.....	36
Article XX.	Fixed Asset Management.....	36
Article XXI.	Effective Date	36
Article XXII.	Amendment and Suspension of Rules and Regulations	36
APPENDIX A	<i>Rhode Island Judiciary General Terms and Conditions of Purchase</i>	1

Article I. Authority

With the passage of 2004-2005 Budget Article 45 the Judiciary was given broad power over its administrative affairs. Specifically, the State Court Administrator and the Chief Justice of the Supreme Court now have sole power over judicial procurements and the power to enact the rules and regulations necessary to carry out the procurement power. R.I.G.L. § 8-15-4.

Article 45 had effectively taken judicial purchasing power away from the Department of Administration and vested it in the Court Administrator and the Chief Justice. The following Judicial Purchasing Rules and Regulations contain a fully integrated set of procedures to govern the Judiciary in its exercise of financial control, independent of the Executive Department.

Article II. Purpose and Policy

The following Judicial Purchasing Rules and Regulations are made in compliance with G.L. 1956, 8-15-4(d), whose purpose is to affirm the right of the Judicial Department to be independent of and not subject to financial control exercised by the executive branch of government in matters relating to the operation of the unified state court system.

These rules and regulations take into consideration and conform to, where practicable, existing policies governing financial and purchasing practices within the executive branch of government. Overall, the Judicial Purchasing Rules and Regulations seek to further the policies of State Purchasing as set forth in Title 37, Chapter 2 of the Rhode Island General Laws.

Specifically, the Judicial Purchasing Rules and Regulations aim to:

- simplify, clarify, and modernize the law governing purchasing by the Judiciary;
- permit the continued development of judicial purchasing policies and practices;
- make judicial purchasing laws as consistent as possible with current purchasing laws;
- provide for increased public confidence in the purchasing procedures followed by the Judiciary;
- insure the fair and equitable treatment of all persons who deal with the procurement system of the Judiciary;
- provide increased economy in judicial procurement activities by fostering effective competition; and
- provide safeguards for the maintenance of a judicial procurement system of quality, integrity and highest ethical standards.

Article III. Scope

The procedures established herein do not create any right or benefit, substantive or procedural, enforceable by a party against the Judiciary or the State of Rhode Island or their officers or employees.

Article IV. Participation in Other State Contracts and Use of Services

Whenever practicable, the Judiciary may utilize existing State of Rhode Island Division of Purchases contracts for products or services. Further, to assure that the lowest possible cost is achieved, the Judiciary may enter into cooperative purchasing agreements with other governmental entities.

Whenever practicable, the Judiciary may use the facilities of the Department of Administration Centralized Purchasing Office, and/or the common services and facilities available to other state entities including but not limited to payroll, central mail room, motor pool and data processing.

Whenever such services are rendered on a cost basis to other state entities, the same charges will apply to the Judiciary.

Article V. Waivers/Deviations

These regulations standardize the manner in which products and services are procured in the Judiciary to the greatest extent possible. Any deviation from the instructions contained herein shall be supported by a waiver signed by the Chairperson of the Judicial Purchasing Committee.

Article VI. Procurement Integrity

Judicial employees are held to the highest standards of conduct in the performance of their duties and must conduct themselves so as to avoid even the appearance of any impropriety. All employees of the Judiciary are to conduct all dealings with potential offerors and contractors in such a manner that no actual occurrence of, or appearance of, favoritism or competitive advantage is given to one business over another in dealing with the Judiciary in accordance with Rhode Island Code of Ethics and Regulations, Chapter 36, Title 14.

The State Court Administrator shall have authority to impose sanctions, in accordance with personnel regulations, on any Judiciary employee who has been found to have violated these regulations.

Article VII. Access to Information

Awarded contracts will generally be available for public inspection, including the successful offer to the extent the offer is incorporated by reference into the contract, including the disclosure of fixed unit prices. However, trade secret information, and confidential or commercial information will not be released.

Article VIII. Judicial Purchasing Committee and Judicial Purchasing Structure

Section 8.01 Judicial Purchasing Committee

There shall be a Judicial Purchasing Committee which shall consist of the Director of Finance/Chief Purchasing Officer, who shall be chairperson; Deputy Director of Finance, who shall be vice chairperson; Assistant State Court Administrator for Technology; Assistant State Court Administrator for Facilities and Operations; and the Judicial Purchasing Agent, who shall be Secretary, or their respective designees.

A quorum shall consist of three (3) members. The Judicial Purchasing Committee may delegate its authority to the Judicial Purchasing Agent, or any other agent(s) and/or employee(s) of the Judiciary.

A. Responsibilities of the Judicial Purchasing Committee

The responsibilities of the Judicial Purchasing Committee shall include but are not limited to:

1. hearing and deciding appeals on bids;
2. developing rules and regulations when necessary, which shall provide for the efficient and effective purchasing function within the Judiciary;
3. ensuring that all procurement activities foster effective competition, such that economies in expenditure can be obtained;
4. administering all procurement activities and determinations with respect to the solicitation and evaluation of competitive offers and to source selection;
5. acting as the sole point of contact with prospective and current offerors, relative to the business, financial and other commercial aspects of all solicitations and offers;
6. issuing specifications for supplies, services, and construction required by the Judiciary;
7. ensuring that all solicitations are prepared in a manner and form which enables suppliers to submit fully responsive and knowledgeable offers, and which clearly define the criteria to be used in evaluating responses;

B. Meetings of the Judicial Purchasing Committee

The Judicial Purchasing Committee shall meet as circumstances require, but in no event, less than once every one hundred eighty (180) calendar days.

C. Judicial Purchasing Structure and Responsibilities

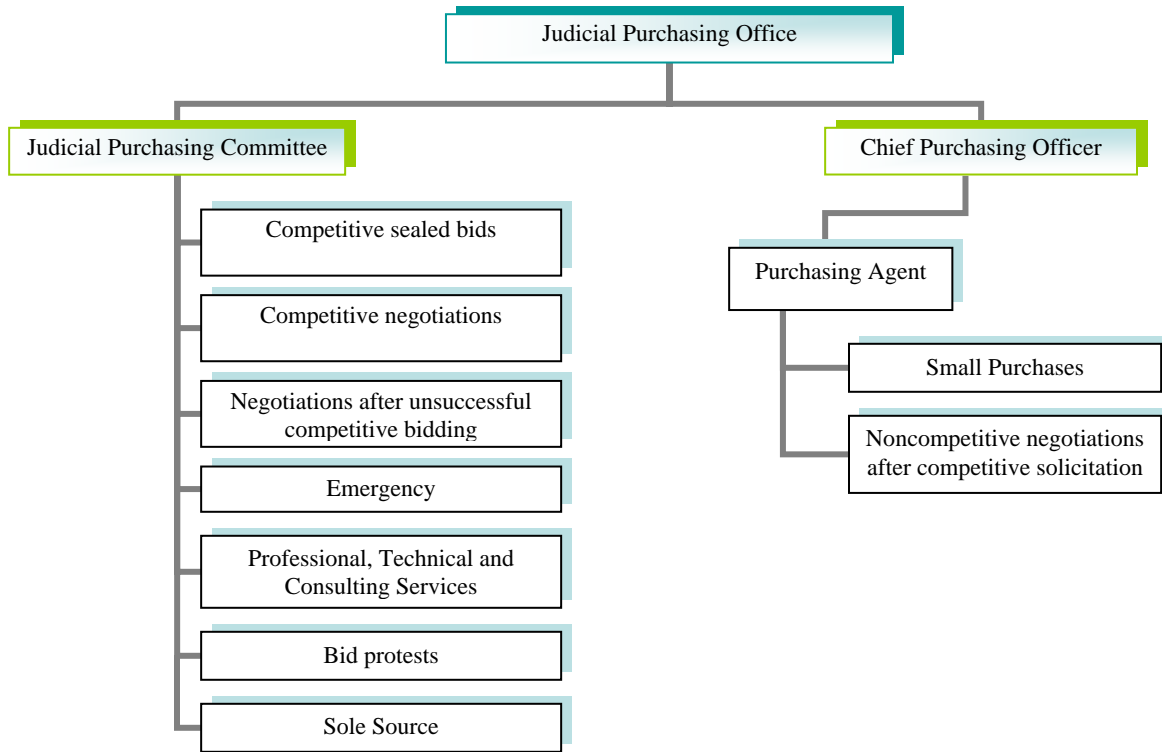

The Judicial Purchasing Committee may establish committees, subcommittees or workgroups as necessary to advise and assist it in carrying out its responsibilities, duties and powers under these Rules and Regulations. The committees, subcommittees or workgroups may be composed of members of the Judicial Purchasing Office, employees of the Judiciary, and/or other persons with the knowledge of the issues or areas of interest that arise before the Judicial Purchasing Committee in the performance of its duties. The committees, subcommittees or workgroups may monitor, study, report and make recommendations to the Judicial Purchasing Committee on any matter that arises during the exercise of its purchasing authority.

Section 8.02 Chief Purchasing Officer

The Chief Purchasing Officer shall attempt in every practicable way to insure that the Judiciary is supplying its needs at the lowest possible cost. The Chief Purchasing Officer shall have the power: to transfer between courts, to salvage, to exchange, and to condemn supplies, and equipment.

The State Court Administrator shall require the Chief Purchasing Officer to furnish an estimate of specific needs for supplies, materials, and equipment to be purchased by competitive bidding for the purpose of permitting scheduling of purchasing in large volume.

The Chief Purchasing Officer, except as otherwise provided by law, shall purchase, or delegate and control the purchase of, the combined requirements of the Judiciary including, but not limited to, interests in real property, contractual services, rentals of all types, supplies, materials, equipment, and services, except competitive bids may not be required:

- (a) For contractual services where no competition exists such as sewage treatment, water, and other public utility services;

- (b) When instructional materials are available from only one source;
- (c) Where rates are fixed by law or ordinance;
- (d) For library books, research or reference materials, services or software;
- (e) For commercial items that are purchased for resale;
- (f) For professional, technical, or artistic services;
- (g) For all other commodities, equipment, and services which, in the reasonable discretion of the Chief Purchasing Officer, are available from only one source;
- (h) For interests in real property.
- (i) For works of art for museum and public display;
- (j) For published books, maps, periodicals, newspaper or journal subscriptions, and technical pamphlets;
- (k) For licenses for use of proprietary or patented systems; and
- (l) For services of visiting speakers, professors, performing artists, and expert witnesses.

Nothing in this section shall deprive the Chief Purchasing Officer from negotiating with vendors who maintain a general service administration price agreement with the United States of America or any agency thereof or other governmental entities, provided, however, that no contract executed under this provision shall authorize a price higher than is contained in the contract between the general service administration and the vendor affected.

Section 8.03 Judicial Purchasing Agent

Within the Judiciary, there shall be a Judicial Purchasing Agent who shall be designated by the Chief Purchasing Officer with the approval of the State Court Administrator, who shall exercise the powers and duties as set forth in these rules and regulations. The Judicial Purchasing Agent shall have the following authorities and responsibilities unless otherwise provided:

- (a) To serve as the central procurement and contracting agent of the Judiciary;
- (b) To recommend regulations, rules, and procedures to the Chief Purchasing Officer;
- (c) To purchase or otherwise acquire, or, with the approval of the Chief Purchasing Officer, to delegate the purchase and acquisition of all supplies, services, and construction for the Judiciary; and
- (d) Any other such duties and responsibilities as the State Court Administrator or Judicial Purchasing Committee shall require.

Article IX. Definitions

The terms contained in these rules and regulations shall be defined according to Rhode Island General Laws Title 37, Chapter 2 and the Department of Administration's Division of Purchases Rules Regulation and General Conditions of Purchase unless the context in which they

are used clearly requires a different meaning or a different definition is prescribed for a particular section, group of sections, or provisions.

Article X. Methods of Source Selection

The Judicial Purchasing Committee or the Chief Purchasing Officer may at any time, determine that it is in the best interest of the Judiciary to utilize those procurement practices and procedures as presently in place through the State of Rhode Island Division of Purchases.

When acquiring products or services, procuring officials must consider the following sources:

Section 10.01 Master Price Agreement (MPA)

A Master Price Agreement (MPA) may be either a Judiciary-wide contract or a State of Rhode Island Division of Purchases contract that takes advantage of buying power and ensures that the Judiciary, through negotiated pricing, obtains the best overall value for products and services for which there are repetitive purchases, taking into account overall pricing structure; quality, delivery and service; support, training, exchange and return policies; compatibility with judicial systems and technology; financial stability; and other judicial requirements.

The Judicial Purchasing Committee may establish a Master Price Agreement under any schedule contract to fill repetitive needs for products or services, but shall use Master Price Agreements adopted by the Rhode Island Judiciary whenever feasible.

Section 10.02 Competitive Sealed Bidding

Competitive sealed bidding means the competitive procurement of products and services made under procedures other than those applicable to small purchase procedures, or as otherwise specifically provided herein. The Judicial Purchasing Committee recognizes that special circumstances may not support the use of competitive bidding. *See Exceptions.* Factors to be considered in determining if competitive sealed bidding is practicable shall include whether specifications can be prepared which permit award on the basis of either the lowest bid price or the lowest evaluated bid price, the available sources, the time and place of performance, and other relevant circumstances appropriate for the use of competitive sealed bidding.

The Judicial Purchasing Committee shall ensure that all procurement activities foster effective competition, such that economies in expenditure can be obtained. A competitive environment shall be considered to exist when two or more items or offers can be compared to determine relative merit and/or objective standards of comparison are fairly and impartially applied. An equal opportunity for participation in any procurement applies to all prospective offerors, and affirmative action to achieve participation in the procurement process as a means of achieving social objectives is accomplished without violation of these general principles.

Except as otherwise provided for herein, the Judicial Purchasing Committee shall be responsible for the administration of all procurement activities and determinations with respect to the solicitation and evaluation of competitive offers, and to source selection.

Information concerning the competitive sealed bidding process shall be confidential.

A. Standards and Specifications

The Judicial Purchasing Committee or its designee shall have the responsibility for issuing specifications for supplies, services, and construction required by the Judiciary. Among its duties, it shall, to the greatest extent practicable:

1. Prepare and issue standard specifications for supplies, services, and construction required by the Judiciary.
2. All specifications shall be drafted so as to maximize, to the extent practicable, competition in fulfillment of the Judiciary requirements.
3. Solicitations shall be prepared in a manner and form which enables suppliers to submit fully responsive and knowledgeable offers, and which clearly define the criteria to be used in evaluating responses.
4. All material submitted by requisitioners to the Judicial Purchasing Office for action shall be in sufficient detail and shall contain adequate supportive information to:
 - (i) Adequately describe the purpose, use, or desired performance level of the requirement; and
 - (ii) Identify measurable criteria for evaluation of offers including, but not limited to, acceptance testing.
 - (iii) Wherever possible, solicitations shall incorporate a standard specification, describing the level of performance required, and measurable criteria which define acceptance.
5. In certain cases, following detailed evaluation, brand name or other designations may be defined as standard items, where it is determined to be in the best interest of the Judiciary with regard to economies of scale, or cost or value analysis.

Unless alternate offers are clearly requested or allowed, only those offers which are responsive, in all material respects, to the terms of the solicitation shall be considered. Alternate specifications may be considered only where it has been determined that the alternate satisfies all objective performance characteristics of the procurement, and represents a reduction in expenditure.

B. Solicitations

Unless otherwise specifically authorized, the Judicial Purchasing Committee shall be the sole point of contact with prospective and current offerors, relative to the business, financial and other commercial aspects of all solicitations and offers.

Judicial employees may be authorized by the Judicial Purchasing Agent to contact suppliers to obtain technical data only prior to the award of a contract.

At least one representative of the Judicial Purchasing Committee shall be present at, or party to, all discussions with suppliers with respect to current solicitations, or with respect to price or delivery information, or with respect to modifications of any contract.

1. Method of Solicitation

The Judicial Purchasing Committee will ensure that all solicitations are prepared in a manner and form which enables suppliers to submit fully responsive and

knowledgeable offers, and which clearly define the criteria to be used in evaluating responses. In general, solicitations will be sent only to those suppliers who have formally expressed a desire to bid on the particular types of items which are the subject of the bid solicitation; however, the Judicial Purchasing Agent may determine that competition would be enhanced by soliciting bidders who are not on the established Judiciary Bidders List.

2. Content of Solicitation

The Judicial Purchasing Committee shall have the responsibility for issuing specifications for supplies, services, and construction required by the Judiciary. Competitive bids shall be obtained from a sufficient number of suppliers to be considered representative of the industry cited. Although three bids shall be considered the minimum, the Judicial Purchasing Committee may in some instances declare the existence of two bids to be considered to provide adequate price competition.

The invitation for bids shall state whether award shall be made on the basis of the lowest bid price or the lowest evaluated or responsive bid price. If the latter basis is used, the objective measurable criteria to be utilized shall be set forth in the invitation for bids, if available.

Selection and evaluation criteria shall be clearly defined in all solicitations.

3. Notification and Advertising

The Chief Purchasing Officer will determine the method by which the solicitation is delivered to potential offerors. This determination will take into consideration such choices as sent via regular mail, or electronic mail, print advertisement or publication, or posted on a website. Advertisements may be placed in publications or on websites directed to minority communities and/or women to enhance opportunities for disadvantaged businesses to participate in the bidding process.

Notices shall be published in sufficient time to afford suppliers a fair opportunity to respond prior to the bid opening date and time, not less than seven (7) days nor more than twenty-eight (28) days before the date set for the opening of the bids. The Judicial Purchasing Agent may make a written determination that there is a need to waive the twenty-eight (28) day limitation. The written determination shall state the reason why the twenty-eight (28) day limitation is being waived and shall state the number of days, giving a minimum and maximum, before the date set for the opening of bids when public notice is to be given.

Advertisements may be utilized in conjunction with requests for quotations or proposals for products or services at any estimated level of expenditure if the Chief Purchasing Officer so determines:

- (i) that the commodity or service is of such special nature that opportunities for competition will be enhanced by extending invitations to other than known suppliers; and/or

- (ii) that a purchase will be of interest to supportive industries, e.g. construction projects; and/or
- (iii) that a purchase is unusually large or infrequent.

The Chief Purchasing Officer may advertise in widely circulated newspapers and/or trade journals to promote effective competition.

4. Amendment or Cancellation of Solicitation

An invitation for bids, a request for proposals, and other solicitation may be cancelled or amended, or all bids or proposals may be rejected, if it is determined in writing that the action is taken in the best interest of the Judiciary and approved by the Judicial Purchasing Committee.

An amendment to a solicitation must be issued in sufficient time to permit offerors to consider it in submitting or modifying their offers.

C. Receipt of Offers

Bids shall be opened publicly at the time and place designated in the invitation for bids. Each bid, together with the name of the bidder, shall be recorded and an abstract made available for public inspection.

D. Withdrawal or Correction of Offers

Correction or withdrawal of bids may be allowed only to the extent permitted by the Judicial Purchasing Committee. The Judicial Purchasing Committee shall be the sole determiner of whether correction or withdrawal of bids may be made without penalty.

Requests by the apparent low bidder for correction of bids identifying all error(s) and specifying corrective action shall be submitted in writing to the Judicial Purchasing Committee and shall be re-evaluated with all other offers. Requests for withdrawal of bids shall be submitted in writing to the Judicial Purchasing Agent, providing an explanation for the action and advising the Judicial Purchasing Committee as to why the bidder should not be suspended from the Judiciary Bidders List.

Correction of a bid at any time prior to bid opening may be permitted by the Judicial Purchasing Committee without penalty when a bidder requests that the bid be returned and a corrected bid resubmitted prior to the bid opening. A vendor who fails to resubmit a corrected bid before the bid opening shall be considered nonresponsive.

The Judicial Purchasing Committee shall respond to requests for correction or withdrawal within ten (10) working days, notifying the bidder of the status of his bid and continued inclusion in the Judiciary Bidders List.

E. Evaluation of Offers

Offer evaluation is an assessment of both the offer and the offeror's ability (as demonstrated by the offeror) to perform the prospective procurement successfully. Offers shall be evaluated by the Judicial Purchasing Committee or its designee on the basis of:

1. The qualifications and reliability of the offerors, established by professional accomplishment and previous experience;
2. The quality of the materials, equipment, services, or supplies to be furnished;
3. The conformity of the offer with the specifications;
4. The purposes for which required;
5. The terms of delivery;
6. Aspects of offers which provide benefit, other than those based on cost; and
7. Other provisions of offers which are determined to serve the best interests of the Judiciary.

Nothing herein shall be construed to preclude the possibility of determining an award solely on the basis of cost. The evaluation of offers, including the weight assigned to various aspects of the offerors, and all award determinations, including the reasons for a selection recommendation, shall be fully documented.

All offers received by the Judicial Purchasing Committee may be rejected if the Judicial Purchasing Committee determines that (1) the prices proposed are unreasonable and discussions have not resulted in a reasonable price or price; (2) all offers are technically unacceptable; or (3) offers were not independently arrived at in open competition, were collusive, or were submitted in bad faith. Under any such circumstances, the Judicial Purchasing Committee may declare all bids unacceptable and re-solicit the procurement.

If a solicitation results in only one proposal, the Judicial Purchasing Committee may evaluate and consider the bid for award or declare the bid unacceptable and either re-solicit the procurement or ask that the price be negotiated with the vendor.

The Judicial Purchasing Committee may eliminate bidders whose offers are clearly noncompetitive prior to resolicitation.

F. Awards

The bid will be awarded to the offeror whose offer receives the highest evaluation in accordance with the specifications of the bid. Evaluations can be made based on the technically acceptable/lowest price of the offeror who meets the technical requirements in the solicitation or based on best value. The contract shall be awarded with reasonable promptness by written notice to the responsive and responsible bidder whose bid is either the lowest bid price or lowest evaluated or responsive bid price.

Bids may not be withdrawn during this period without penalty without the express permission of the Judicial Purchasing Committee.

The Judicial Purchasing Committee may, after considering the overall cost to the Judiciary prior to making a final determination of award, apply special consideration to the offers of minority business enterprises when:

1. the solicitation provides for such consideration;
2. the offer is fully responsive to the terms and conditions of the solicitation;
3. the price offer made by the MBE is determined to be within a competitive range (not to exceed five percent (5%) higher than the lowest responsive price offer) for the product or service; and
4. the firm making the offer conforms to the definition of a minority business enterprise.

An award may be made by written acceptance of an offer or by execution of a procurement by both parties.

G. Negotiations After Unsuccessful Competitive Sealed Bidding

1. In the event that all bids submitted pursuant to competitive sealed bidding under Section 10.02 (“Competitive Sealed Bidding”) result in bid prices in excess of the funds available for the purchase and the Chief Purchasing Officer determines in writing:

(i) That there are no additional funds available from any source so as to permit an award to the lowest responsive and responsible bidder, and

(ii) The best interest of the state will not permit the delay attendant to a resolicitation under revised specifications, or for revised quantities, under competitive sealed bidding as provided in Section 10.02 (“Competitive Sealed Bidding”), then a negotiated award may be made as set forth in subsection (2) or (4) of this section.

2. Where there is more than one bidder, competitive negotiations, pursuant to Section 10.02 (“Competitive Sealed Bidding”), shall be conducted with the three (3) or two (2) if there are only two (2) bidders, determined in writing to be the lowest responsive and responsible bidders to the competitive sealed bid invitation. Competitive negotiations shall be conducted under the following restrictions:

(i) If discussions pertaining to the revision of the specifications or quantities are held with any potential offeror, all other potential offerors shall be afforded an opportunity to take part in such discussions; and

(ii) A request for proposals, based upon revised specifications or quantities, shall be issued as promptly as possible, shall provide for an expeditious response to the revised requirements, and shall be awarded upon the basis of the lowest bid price, or lowest evaluated bid price submitted by any responsive and responsible offeror.

3. Contracts may be competitively negotiated when it is determined in writing by the Judicial Purchasing Agent that the bid prices received by competitive sealed bidding were not independently reached in open competition, and for which:

- (i) Each competitive bidder has been notified of the intention to negotiate and is given reasonable opportunity to negotiate; and
- (ii) The negotiated price is lower than the lowest rejected bid by any competitive bidder; and
- (iii) The negotiated price is the lowest negotiated price offered by a competitive offeror.

4. When, after competitive sealed bidding, it is determined in writing that there is only one responsive and responsible bidder, a negotiated award may be made with the bidder.

H. Protest Procedures

A mere disagreement with the decision of the Judicial Purchasing Committee does not constitute grounds for a protest. A “protest” for purposes of these procedures is a written objection by an interested party to any of the following:

- a solicitation of other requests for offers for the procurement of products or services;
- an award or proposed award of a procurement; and
- a cancellation of the solicitation or other request.

1. Interested Parties

For purposes of filing a protest, an interested party means an actual or prospective offeror whose direct economic interest would be affected by the award of a procurement or by the failure to award a procurement.

2. Filing and Form of Protest

A Judiciary protest must be filed in writing with the Chief Purchasing Officer with a copy to the Judicial Purchasing Committee within two (2) calendar weeks after the interested person knows or should have known of the facts giving rise to the protest. A statement of intent to file a protest is not a protest.

Protests must include the protestor’s name, address and telephone number, fax number and email address, the solicitation or procurement number, the identity of the contracting activity, and a detailed statement of all legal and factual grounds for the protest including a description of the alleged prejudice to the protestor, copies of all relevant documents, a request of relief and the protestor’s suggested form of relief, all information establishing that the protestor is an interested party, and proof of timeliness.

3. Protest Decision

The Chief Purchasing Officer shall forward the protest to the Judicial Purchasing Committee along with his explanation and recommendation. The Judicial Purchasing Committee or its designee shall issue a written decision on the protest within ten (10) business days after the filing of the protest that provides sufficient explanation for the basis of the decision.

4. Protest Filed Before Award

When a timely protest has been filed with the Chief Purchasing Officer before award, award may not be made until the matter has been resolved, unless the Chief Purchasing Officer with the concurrence of the Judicial Purchasing Committee determines in writing that urgent and compelling circumstances which significantly affect the interests of the Judiciary will not permit delay of the award until the protest has been resolved, and that the award must be made without awaiting the decision. When authorized to make an award before a protest is resolved, the Chief Purchasing Officer must inform the protestor in writing of the Judiciary's determination to proceed with the award.

5. Protest Filed After Award

When a protest is filed within two (2) calendar weeks after an award, the Chief Purchasing Officer shall immediately suspend performance pending resolution of the protest by the Judicial Purchasing Committee or its designee. Performance need not be suspended in those circumstances where the Chief Purchasing Officer determines in writing, that urgent and compelling circumstances exist or it is otherwise in the best interests of the Judiciary to allow the contractor to proceed. Prior to making such a determination, the Chief Purchasing Officer must consult with and obtain the approval of the Judicial Purchasing Committee.

Section 10.03 Competitive Negotiations

Competitive negotiation shall mean a specialized bidding procedure characterized by modifications to the offers of at least two vendors and/or alteration of the specifications for which, or the terms and conditions under which, the state has solicited offers.

A contract may be awarded by competitive negotiation when the Judicial Purchasing Agent determines in writing that the use of competitive sealed bidding is not practicable where:

- Lowest price is not the sole or primary consideration to be used in determining an award; or
- Performance is neither specific nor objective, and open to the offeror's interpretation; or
- It is otherwise anticipated that offers may be substantially different and that there is insufficient common ground for objective comparison; or
- It is anticipated that changes will be made after proposals are opened and that the nature of the proposals and/or prices offered will be negotiated prior to award.

Requests for Proposal (RFP) shall be utilized to solicit competitive offers.

A. Content of Request for Proposal

1. Wherever possible, the Request for Proposal shall define the performance or benefit required and shall set forth specific criteria to be utilized in evaluation of offers.
2. The request for proposals shall indicate the relative importance of price and other evaluation factors.

B. Procedure for Competitive Negotiations

Adequate public notice of the request for proposals to be negotiated shall be given in the same manner as Competitive Sealed Bidding as provided in Section 10.02(B)(3) (“Notification and Advertising”).

Written or oral discussions may be conducted with all responsible offerors who submit proposals determined in writing to be reasonably susceptible of being selected for award. Discussions shall not disclose any information derived from proposals submitted by competing offerors. Award shall be made by the Judicial Purchasing Committee or its designee(s) to the responsible offeror whose proposal is determined in writing to be the most advantageous to the Judiciary, taking into consideration price and the evaluation factors set forth in the request for proposals. Discussions need not be conducted:

- (1) With respect to prices, where the prices are fixed by law or regulation, except that consideration shall be given to competitive terms and conditions;
- (2) Where time of delivery or performance will not permit discussions; or
- (3) Where it can be clearly demonstrated and documented from the existence of adequate competition or accurate prior cost experience with the particular supply, service, or construction item that acceptance of an initial offer without discussion would result in fair and reasonable prices, and the request for proposals notifies all offerors of the possibility that an award may be made on the basis of the initial offers.

Section 10.04 Non Competitive Negotiations

Non competitive negotiation shall mean the establishment of contractual terms and conditions, including but not limited to contract price, by discussions with a single vendor, outside of the procedures established for competitive bidding.

Section 10.05 Exceptions

The following exceptions to competitive bidding are permitted; however, the Judicial Purchasing Agent and/or Judicial Purchasing Committee may require competitive bidding in any circumstance where it is determined that competition may enhance the Judiciary’s ability to attain cost savings:

- Contractual services where no competition exists, such as telephone service, electrical energy, and other public utility services;
- Instructional materials available from only one source;
- Where rates are fixed by law or ordinance;
- Library books, research or reference materials, services or software;
- Professional, technical, or artistic services
- Goods or services obtained by one state agency from another (such as printing or services from Prison Industries or use of Central Service Accounts)

Competition should be sought for any open market purchase unless:

- Exigencies require the immediate delivery of the products or performance of the services due to unusual and compelling urgency (**emergency**);
- Only one responsible source of supply is available and no other products or services will satisfy Judiciary requirements (**sole source**);
- The services are required to be performed by a contractor or consultant in person and are of a professional, technical or consulting nature (**professional, technical and consulting assistance**); or
- The purchase is an open market fixed price purchase for a product or service up to \$5,000 (**small purchase**).

A. Emergency

The Judicial Purchasing Committee shall be permitted to react quickly to critical or urgent situations when the cost for a remedy or repair and there is not sufficient time to undertake a public, formal, or informal bidding process.

Notwithstanding any other provision of this chapter, the Judicial Purchasing Committee may make or authorize others to make emergency procurements when there exists an unusual and compelling urgency, including but not limited to failures of critical equipment, a threat to public health, welfare, or safety under emergency conditions; provided, that the emergency procurements shall be made with such competition as is practicable under the circumstances.

A written determination of the basis for the emergency, and for the selection of the particular contractor, shall be included in the contract file.

B. Sole source

The Judiciary shall take all reasonable steps to avoid contracting without providing for full and open competition, however, there are valid circumstances when it is both necessary and in the best interest of the Judiciary to award a sole source procurement.

Sole source is a term used to designate that only one responsible supplier exists that is capable of providing a particular product or service. Sole source purchases are an exception to the judicial competitive bidding policy, and must always be in writing. The Judicial Purchasing Committee will approve sole source purchases on a case-by-case basis. In the case of an emergency, the Chief Purchasing Officer or his designee may serve as the authority for sole source purchasing.

1. *Sole source categories may include:*
 - (a) items of a unique nature which are unavailable from other sources due to patents or proprietary processes;
 - (b) books, maps, periodicals, and technical pamphlets, films, video and audio cassettes obtained from publishers;
 - (c) certain computer software;
 - (d) licenses - computer software, electronic transmittal;
 - (e) specialized replacement/repair parts or expansion parts necessary to maintain the integrity of system or function, e.g. scientific research;

- (f) works of art for museum or public display;
- (g) specialized services for which there is only one documented accepted source, such as transactions involving unique professional services and/or educational institutions, e.g., visiting speakers or professors, and performing artists; repair/maintenance agreements with manufacturers;
- (h) advertisements, public notices in magazines, trade journals, newspapers, television, public relations and advertising campaign services;
- (i) maintenance contracts based upon sole source determination shall be subject to the following:
 - (a) Annual maintenance contracts not covered by a master price agreement (MPA) in excess of \$50,000 shall require approval by the Judicial Purchasing Committee.
 - (b) All multi-year contracts shall require approval by the Judicial Purchasing Committee.
- (j) services provided by certain non profit agencies
- (k) Guest speakers, honoraria, subscriptions, dues, memberships and other similar items will be treated as sole source, and do not require sole source justification documentation.

C. Professional, Technical and Consulting Assistance

The Judiciary shall be permitted to retain such professional, technical and consulting services as it deems necessary, including but not limited to legal, medical, dental, architectural, or engineering services, and to set the amounts and terms of such service contracts, subject to the approval of the Judicial Purchasing Committee.

D. Small Purchases

Small purchase procedures are for use in making open market fixed price purchases for products or services up to \$5,000, with competition via competitive sealed bidding, competitive negotiation or informal competitive bids, or without competition, provided that the Judicial Purchasing Agent determines the price to be reasonable.

E. Informal Competitive Bids

Oral quotations (including telephone) may be solicited for small purchase orders. If the Judicial Purchasing Agent is unable to verify prices using published lists/catalogs or by market analysis, the lowest quotation obtained by telephone solicitation for procurements shall be confirmed in writing.

An informal bid shall be distinguished by:

- (a) lack of a specific time by which bids must be submitted;
- (b) lack of sealed written bids; quotes may be oral on the spot or by telephone and confirmed at a later date in writing;
- (c) lack of an opening and reading of bids;
- (d) the solicitation of selected registered or unregistered bidders who are potential suppliers for the commodity or service to be procured and/or vendors suggested for consideration.

Informal bids shall be solicited from a minimum of three suppliers. All informal bid invitations shall be conducted in such fashion as to maximize the opportunity for participation of all responsible suppliers.

When informal competitive bids are received in accordance with the provisions contained herein and award is not made to the low bidder, the file shall be annotated with statements of how the supplier was selected and why the price is fair and reasonable.

F. Direct Billing

Direct invoicing, the means of paying a bill without having to create a purchase order, should be done for the following instances:

- a. Utilities;
- b. Food;
- c. Telephone bills;
- d. Registration fees; and
- e. In-state travel reimbursement.

Bills that meet these criteria should be forwarded to the Judiciary's Accounts Payable Department for payment.

Article XI. Contractor Prequalification, Qualification and Solicitation

The Judiciary shall procure from responsible contractors only. Therefore, the Judicial Purchasing Committee must not solicit offers from, award procurements to, or consent to subcontracts with debarred, suspended, or ineligible contractors or affiliates thereof, unless the Judicial Purchasing Committee determines that there is a compelling reason for such action in the interest of the Judiciary.

- A reasonable inquiry to determine the financial strength and responsibility of a business which is a bidder or offeror shall be conducted and a written determination of responsibility shall be made. Said financial analysis may include the review of the business by a nationally recognized commercial credit reporting bureau. Credit bureau reports may be required by the Chief Purchasing Officer in conjunction with a financial analysis.
- Except as otherwise provided by law, information furnished by a bidder or offeror pursuant to this section may not be disclosed outside of Judiciary without prior written consent of the bidder or offeror.

Section 11.01 Definitions

A. Registered Suppliers- the names of interested suppliers who have submitted completed Judiciary Bidder Registration Forms to the Judicial Purchasing Office that have been reviewed and approved by the Judicial Purchasing Agent.

B. Unregistered Suppliers - suppliers that have not expressed interest in selling to the Judiciary by submitting a Judiciary Bidder Registration Form, but who have been determined by the Judicial Purchasing Agent, due to the nature of the firm's status in the market, to be responsible and qualified with regard to particular commodities. Inclusion of any firm on the Judiciary Bidders List without a supporting registration form shall be permitted with the written approval of the Judicial Purchasing Agent.

Section 11.02 Responsibilities of Bidders and Offerors

A written determination of responsibility of a bidder or offeror shall be made by the Judicial Purchasing Agent. The Judicial Purchasing Agent may utilize factors such as financial capability, reputation, management, etc., to evaluate the responsibility and qualifications of potential suppliers in order to develop a list of prospective bidders qualified to be sent invitations to bid. The failure of a bidder or offeror to supply information promptly (within 5 business days or unless otherwise specified) in connection with an inquiry related to responsibility may be grounds for a determination of nonresponsibility.

The Judicial Purchasing Agent may disqualify a supplier, contractor, or subcontractor from participating in Judiciary Bidding Lists. Just cause for such determination may include but shall not be limited to:

- Lack of a properly prepared and submitted Bidder Registration Form;
- Refusal to submit a Bidder Registration Form;
- Falsification of information on Bidder Registration or Certification Forms;
- Suspension or debarment by the federal government or the Rhode Island Department of Administration;
- Conviction of fraud or perjury;
- Lack of competence, financial responsibility, or other limitations related to the ability of a supplier to provide the goods and services indicated on its Bidder Registration Form;
- Failure of a bidder or offeror to promptly supply information in connection with an inquiry, including but not limited to financial statements and business references, shall be grounds for a determination of nonresponsibility with respect to such a bidder or offeror; or
- Any reason stipulated in Section 11.08 entitled “Vendor Disqualification” of these regulations.

Based on the Judicial Purchasing Agent's review of a supplier's level of financial responsibility and/or qualification, the Judicial Purchasing Agent may restrict the items or size of orders for which a supplier will be solicited. Restriction shall relate to:

- limiting the kinds of goods and services for which the supplier may be solicited to a portion of those indicated on a Bidder Registration Form.
- limiting the scope/amount of goods and services for which the supplier may be solicited (e.g., categorizing a contractor by the size of construction projects it is deemed capable of undertaking).

Section 11.03 Bidder Registration Form

The Judicial Purchasing Agent may require interested suppliers to submit completed Bidder Registration Forms to the Judicial Purchasing Office for consideration by the Judicial Purchasing Agent. If required bidder certifications are determined to be invalid, the Purchasing Agent may declare the purchase order void.

A copy of the Judiciary's General Terms and Conditions of Purchase shall be made available with the Bidder Registration Form.

The Bidder Registration Form shall be signed by a representative of the supplier who has the capacity to enter into contracts. The signature shall be an original signature made in ink and dated by the signatory. The signature shall affirm that:

- any and all information on the Registration Form is true and accurate;
- the existence of relationship (blood, spousal, adoptive, financial, etc.) between a principal of the firm and any State/Judiciary employee where a conflict of interest may exist has been disclosed; and
- that falsification of information contained on a signed Registration Form may be grounds for criminal charges of perjury and that conviction of such charges may be grounds for debarment.

As a prerequisite condition for contract award, the Judicial Purchasing Agent may require any bidder to complete a Bidder Registration Form and/or submit current certifications of financial responsibility, affirmative action compliance, drug-free free environment, and status as small, women-owned and/or disadvantaged businesses.

The Judicial Purchasing Agent may require registered suppliers to resubmit updated Bidder Registration Forms annually.

Section 11.04 Bidder Registration Fee

The Chief Purchasing Officer may adopt regulations to establish an annual fee, of not less than twenty-five dollars (\$25.00), which shall be paid by all potential bidders requesting to subscribe to solicitation mailings for public bids for specific types of supplies, services, and construction during a fiscal year, and may waive said fee for Rhode Island firms. Additionally, the Chief Purchasing Officer may delegate to the Judicial Purchasing Agent the authority to waive said fee for an individual solicitation and to include unregistered bidders in the solicitation in the interest of expanding competition. Nothing herein shall prevent any interested party from submitting a bid in response to any solicitation of which they become aware.

Section 11.05 Vendor Information Files

The Judicial Purchasing Office shall maintain Vendor Information Files for the following documentation purposes:

- A. General
 - Bidder Registration Forms

- Results of investigations for prequalification, responsibility, suspension, debarment, restriction, and nonperformance
- Certifications
- Correspondence

B. Bidding History

C. Performance History

- Solicited and unsolicited reports regarding contract performance (e.g., quality, responsiveness) shall be recorded in the Vendor Information File.
- Complaints shall be investigated by Judicial Purchasing Office staff, the results submitted to the Judicial Purchasing Agent for adjudication, and the results documented and maintained in the Vendor Information File.

Potential bidders who have been determined by the Judicial Purchasing Agent to be brokers or jobbers shall not be included on Judiciary Bidders Lists.

Firms bidding on construction or building renovation must demonstrate an ability to perform a substantial portion of the subject work using their own forces. Bidders who do not maintain permanent workforces, or who propose to subcontract a disproportionate percentage of project work shall be considered unqualified, and the Judicial Purchasing Agent reserves the right to reject their offers.

Section 11.06 Prequalification of Contractors

The Chief Purchasing Officer may provide for prequalification of suppliers as responsible prospective contractors for particular types of supplies, services, and construction. Solicitation mailing lists of potential contractors of such supplies, services, and construction shall include but need not be limited to such prequalified contractors.

Prequalification shall not foreclose a written determination:

- (1) Between the time of the bid opening or receipt of offers and the making of an award, that a prequalified supplier is not responsible; or
- (2) That a supplier who is not prequalified at the time of bid opening or receipt of offers is responsible.

Prequalification information may be submitted within a time period subsequent to a project bidder's conference, which period has been specified in the bid solicitation.

The Judicial Purchasing Agent may conduct supplementary prequalification examinations of registered bidders prior to solicitation or award which include, but are not limited to:

- requirement for additional certification(s);
- requirement for demonstration of additional licensure;
- requirement for recent financial information;
- submission of an affirmative action employment plan;
- submission of the names of proposed small disadvantaged business; and/or

- subcontractors and the value of such subcontracts.

Inclusion of a supplier on Judiciary Bidders Lists shall not constitute a prequalification determination for a specific procurement.

Section 11.07 Construction Management

A person who bids on a construction management contract shall provide the following information, which information shall constitute the prequalifications for a construction management contract:

A. Firm history

Name of the firm, location of principal and branch offices, length of time in business, firm ownership structure, and annual construction management volume for each of the past five (5) years including number of projects and total construction volume.

B. Personnel

Total number of the firm's personnel, other than secretarial/clerical, by professional or skill group and outside firms which will be used to provide such services as estimating, value engineering analysis, scheduling or computer services.

C. Experience

Information regarding projects which the firm has constructed during the past five (5) years, including those where the firm has served as construction manager: project name and address, year completed, type of project, construction cost, and a reference(s).

D. Project Staffing

1. The firm's proposed management staff for the project, including an organizational chart identifying the firm's key staff members and showing how each staff member interacts with other staff members assigned to the project, and
2. A detailed resume for each key staff member which summarizes education, professional registration, professional society membership, construction experience, and construction management project experience.

E. Services

1. Scope of preconstruction phase services, including how such services are provided, with specific attention to the first budget estimate, methods of cost control, scheduling, value engineering and the method of reporting project status and schedule position;
2. Scope of construction phase services and how such services are to be provided;
3. The firm's method of working with the project architects, engineers, consultants and other planning team members; and
4. The firm's method of coordinating the efforts of various trade contractors.

Section 11.08 Vendor Disqualification

The Judicial Purchasing Agent, with the approval of the Judicial Purchasing Committee, may disqualify a supplier, contractor, or subcontractor from participating in Judiciary procurements. Disqualification may result in any of the following actions being taken:

1. Debarment - permanent removal from Judiciary Bidders Lists and exclusion from all subsequent procurements, and termination of all outstanding Judiciary contracts; or
2. Suspension - temporary removal from Judiciary Bidders Lists and exclusion from subsequent procurements, and termination of outstanding contracts (at the discretion of the Judicial Purchasing Agent) for a specified period of time; or
3. Removal - deletion from Judiciary Bidders Lists, without interruption of outstanding contracts or the ability to participate in subsequent procurements; or
4. Rejection - lack of inclusion on Judiciary Bidders Lists or non-consideration of an offer submitted for a particular procurement, based on lack of demonstrated responsibility or competency.

A. Rejection and Removal

A vendor's offer for a specific procurement may be rejected for any of the causes described for suspension, or where, in the judgment of the Judicial Purchasing Agent, with the approval of the Judicial Purchasing Committee, the vendor does not possess the capacity, capability, or integrity requisite for the procurement.

Failure to respond to three consecutive solicitations for products or services that a vendor has indicated an interest or ability in supplying on a Bidder Registration form, or a demonstrated lack of success in receiving awards, shall constitute grounds for removal from the Judiciary Bidders List(s) in question.

B. Debarment and Suspension from Bidders List

1. Applicability

A debarment or suspension judgment against a part of a corporate entity constitutes debarment or suspension of all of its divisions and all other organizational elements, except where the action has been specifically limited in scope and application, and may include all known corporate affiliates of a contractor, when such offense or act occurred in connection with the affiliate's performance of duties for or on behalf of the contractor, or with the knowledge, approval, or acquiescence of the contractor or one or more of its principals or directors, or where the contractor otherwise participated in, knew of, or had reason to know of the acts.

The fraudulent, criminal or other serious improper conduct of any officer, director, shareholder, partner, employee, or any other individual associated with a contractor may be imputed to the contractor when the conduct occurred in connection with the individual's performance of duties for or on behalf of the contractor, or with the contractor's knowledge, approval, or acquiescence. The contractor's acceptance of benefits derived from the conduct shall be evidence of such knowledge, approval, or acquiescence.

2. Just Cause for Debarment

Just cause for debarment may include, but shall not be limited to:

- a. Conviction or final adjudication by a court or administrative agency of competent jurisdiction of any of the following offenses:
 - Criminal offense incident to obtaining or attempting to obtain a public contract or subcontract, or the performance of such contract or subcontract, in any jurisdiction, or
 - Criminal offense involving embezzlement, theft, fraud, perjury, forgery, bribery, falsification or destruction of records, receiving stolen property (or any other offense indicating a lack of business integrity or honesty which seriously and directly affects the contractor's present responsibility as a public contractor), or
 - Violation of state or federal antitrust laws relative to the submission of bids or proposals (including those proscribing price fixing between competitors, allocation of customers between competitors, and bid rigging), or
 - Violation of state or federal laws regulating campaign contributions;
 - Violation of state or federal laws regulating equal employment opportunity or handicapped access.

 - b. Violation of the terms of a public agreement or transaction so serious as to affect the integrity of any agency program;

 - c. Falsification of information on a bid submission or Bidder Registration form, subcontracting plan, or affirmative action plan;

 - d. Substantial nonperformance on two or more contracts;

 - e. Debarment by the federal government or the Rhode Island Department of Administration; or

 - f. Withdrawal, without written permission of the Judicial Purchasing Agent, of two or more bids after an award has been announced.
3. Just cause for Suspension
- Just cause for suspension may include, but shall not be limited to:
- a. Any cause for debarment, depending on the severity of the violation;

 - b. An indictment or any information filed by a public agency charging a criminal offense as described above for debarment;

 - c. Substantial evidence of willfully supplying materially false information incident to obtaining or attempting to obtain or performing any public contract or subcontract, or willful failure to comply with requirements imposed upon contractors or subcontractors by law or regulation;

 - d. Suspension by the federal government or the Rhode Island Department of Administration;

- e. Substantial nonperformance on at least one contract;
- f. Lack of responsibility evidenced by:
 - Withdrawal of two or more bids within a two-year period, even with the consent of the Judicial Purchasing Agent, or
 - Correction following public or formal opening of two or more bids within a two-year period, even with the consent of the Judicial Purchasing Agent, or
 - Rejection for non-responsiveness of two or more bids within a two-year period.
- g. A vendor or contractor who knowingly engages as a subcontractor, for a contract awarded by the Judiciary, a vendor or contractor then under a ruling of suspension or debarment by the Judiciary shall be subject to disallowance of cost, annulment or termination of award, issuance of a stop work order, debarment or suspension, as may be judged to be appropriate by the Judicial Purchasing Agent.

4. Duration of Suspension

The Judicial Purchasing Agent may suspend a vendor for not less than a three-month and not more than a two-year period, depending on the severity of a particular violation, provided however that where the cause of the suspension is a criminal indictment as described above, the suspension shall remain in force until such time as the court has disposed of the indictment.

5. Pest Control Services

Upon receipt of an order from the Director of Environmental Management pursuant to section 23-25-28(a)(1) RIGL, the Judicial Purchasing Agent shall take such steps as are necessary to insure that the named business or commercial applicator shall not be eligible to receive Judiciary contracts for pest control services for the duration of the period enumerated in said Director's order.

Section 11.09 Notification, Protest and Reconsideration

A. Notice

The Judicial Purchasing Agent shall notify in writing any vendor whom he or she intends to debar or suspend. Such notice shall:

- state the nature of and, in the case of suspension, the duration of the sanction;
- provide the vendor with the rationale for the decision; and
- establish a specific time for reconsideration not less than two weeks nor more than three weeks within which the vendor may provide justification for why such action should not be implemented.

Where issuance of a purchase order or other award to a particular vendor may compromise the best interests of the Judiciary, nothing herein prevents the Judicial Purchasing Agent from directing that a suspension or debarment take effect immediately.

No notice shall be required where the Judicial Purchasing Agent rejects the offer of a bidder for an individual procurement, or removes a registered bidder from one or more Judiciary Bidders List(s), as described above.

B. Protests

Protests of decisions rendered by the Judicial Purchasing Agent shall be administered in accordance with the requirements of section 10.02(H) (“Protest Procedures”).

C. Reconsideration

Where reconsideration has been requested in writing by a vendor, the Judicial Purchasing Agent shall, upon expiration of the reconsideration period, notify the affected vendor of his or her final decision. Where no such request is received, the action shall be implemented without notice.

A vendor who has been suspended, or rejected from one or more Judiciary Bidders List(s), shall not be reinstated until he has submitted a written request for reinstatement to the Judicial Purchasing Agent, with evidence that the reason for suspension, rejection, or removal has been corrected.

Section 11.10 Public Works Contracts

Ability to meet performance bond requirements set forth for public works contractor in Chapters 37-12 and 37-13-14 shall be valid criteria for determination of responsibility, provided that the Judicial Purchasing Agent may waive such requirement for good cause for contracts not exceeding fifty thousand dollars (\$50,000).

Article XII. General Terms and Conditions of Purchase

Section 12.01 General Terms and Conditions

The Judicial Purchasing Office shall develop and make available to potential suppliers and Judiciary officials a document stating the general terms and conditions applicable to all quotations and judicial purchasing contracts. These terms and conditions are contained in *Appendix A*.

The General Terms and Conditions shall (1) be referenced and made a part of all solicitations for proposals and quotations; all judicial purchase orders, contracts, and letters of authorization; and bidder registration documentation and (2) provide notice to bidders that contract award may be subject to the bidder signing an affirmation (certification) regarding certain legal requirements or restrictions relating to foreign corporations, disadvantaged business enterprises, labor rates, local product preference, etc., as required by the Judicial Purchasing Agent.

When a contract has been entered into between the Judiciary and another party, neither party shall have the legal right to add new terms or conditions without the consent of the other, unless the contract so specifies. Changes in scope, price, and length of contract period shall require contract amendments which are specified in writing. Unanticipated changes may be considered with the express consent of both parties. The issuance of a Purchase Change Order in

accordance with the provisions of the contract and other requirements specified herein shall be considered a binding contract. All contract pricing shall be firm and fixed unless contract language provides for reconsideration, and the length of contract period shall be specified.

A judicial official (or position) from whom the contractor shall obtain direction shall be named and/or a format for written authorization to deliver (e.g., request for delivery form for master pricing agreement) shall be specified.

Issuance of purchase orders shall not be made on the basis of "advise pricing" (or "pricing to be determined") agreements. All commitments shall be on the basis of estimated prices with a "not to exceed" maximum authorization when firm, fixed pricing agreements are not possible.

As appropriate, contracts with the Judiciary shall include clauses which address special conditions/procedures for suspension or termination of a contract not contained in the Judiciary's General Terms and Conditions; e.g., provisions for penalties or forfeitures for contract noncompliance may be included; a convenience termination clause which permits the Judiciary to suspend or terminate, at its own discretion, the performance of work in whole or in part, and to make a settlement of the vendor's claims in accordance with appropriate regulations and applicable contractual conditions.

Section 12.02 Purchase Order Contracts

"Purchase Order" shall mean a document issued by the Judicial Purchasing Agent to formalize a purchase transaction with a vendor. The purchase order shall contain statements as to the quantity, description, and price of the goods or services ordered, applicable terms as to payment, discounts, date of performance, transportation, and other factors or suitable references pertinent to the purchase and execution by the vendor. Purchase orders shall include blanket orders, master pricing agreements, and utility purchase orders.

The entire agreement with the supplier shall, at all times, reside solely in the purchase order and its referenced supplements.

Purchase Order Supplements shall consist of all of the following documents:

1. The Judiciary's General Terms and Conditions of Purchase;
2. The Judiciary's request for quotations or proposals, including specifications;
3. The contractor's offer which is responsive to the solicitation; and/or
4. As appropriate, additional contract provisions.

Article XIII. Multi-Year Contracts

A. Unless otherwise provided, multi-year contracts for supplies and services may be entered into for periods extending beyond the end of the fiscal year in which the contract was made, if funds for the first fiscal year of the contemplated contract are available at the time of contracting and the contract states that payment and performance obligations for succeeding fiscal years shall be subject to the availability of funds therefor.

B. Prior to the utilization of a contract as described in subsection (a) of this section, it shall be determined, in writing, by the Chief Purchasing Officer:

1. That estimated requirements cover the period of the contract, are reasonably firm, and continuing; and
2. That the contract will serve the best interests of the Judiciary by encouraging effective competition or otherwise promoting economics in Judiciary procurement.

C. When funds are not appropriated or otherwise made available to support continuation of performance in a subsequent year of a contract as described in subsection (A) of this section, the contract for the subsequent year may be cancelled and the contractor shall be reimbursed for the reasonable value of any nonrecurring costs incurred but not amortized in the price of the supplies or services delivered under the contract. The cost of cancellation may be paid from:

1. Appropriations currently available for performance of the contract;
2. Appropriations currently available for procurement of similar supplies or services and not otherwise obligated; or
3. Appropriations made specifically for the payment of cancellation costs.

Article XIV. Letter of Authorization

When the Judicial Purchasing Agent determines in writing that it is absolutely essential that the vendor be given a binding commitment so that work can be commenced immediately and that negotiation of a definitive contract cannot be accomplished in sufficient time, the Judicial Purchasing Agent may issue a Letter of Authorization (“LA”).

Section 14.01 Definition and Purpose

A Letter of Authorization (“LA”) shall mean a written instrument binding only when signed by the Judicial Purchasing Agent, which authorizes immediate commencement of implementation of the delivery of supplies or the performance of services. Such instrument shall:

- Represent a preliminary authorization subject to the subsequent issuance of a Purchase Order.
- Be superseded by a definitive contract at the earliest practicable date not later than the expiration of 180 days from the date of the LA or delivery of 40% of the contract.
- Be specifically negotiated and shall address the following contractual requirements that:
 - the vendor will proceed immediately with performance of the contract, including procurement of necessary materials;

- the extent and method of payments in the event of termination for the convenience of the Judiciary or for default;
- the vendor is not authorized to expend monies or incur obligations in excess of the maximum liability of the Judiciary as set forth in the letter contract;
- the type of definitive contract contemplated;
- as many definitive contract provisions as possible;
- the vendor shall provide such price and cost information as may reasonably be required by the Judiciary; and
- the vendor and the Judiciary shall enter into negotiations promptly and in good faith to each agreement and execute a definitive contract.

Section 14.02 Changes to Purchase Orders

All agreements and changes to scope of work, price, or other terms shall be incorporated into purchase orders via "change order" documents incorporating contract amendments.

Change Orders issued by the Judicial Purchasing Office shall be the only binding documents which may create a change in a purchase order.

Judiciary personnel shall not commit the Judiciary to technical/contractual changes to purchase orders without first securing all necessary approvals.

All discussions of potential changes (oral or written) may be disclaimed as not being binding on the supplier or the Judiciary until formally incorporated in the purchase order.

In general, change orders shall be issued by the Judicial Purchasing Office following receipt of quotations and discussions of price and delivery with the supplier. If circumstances preclude immediate issuance of a formal change order, interim direction to the supplier may be made via a letter of authorization signed by the Judicial Purchasing Agent.

Section 14.03 Suspension or Termination of Contract

A. Suspension of a Contract by the Judiciary

The Judiciary reserves the right at any time and for any reason to suspend all or part of this contract, for a reasonable period, not to exceed sixty days, unless the parties agree to a longer period. The Judiciary shall provide the contractor with written notice of the suspension order signed by the Purchasing Agent or his or her designee, which shall set forth the date upon which the suspension shall take effect, the date of its expiration, and all applicable instructions. Upon receipt of said order, the contractor shall immediately comply with the order and suspend all work under this contract as specified in the order. The contractor shall take all reasonable steps to mitigate costs and adverse impact to the work specified in the contract during the suspension period. Before the order expires, the Judiciary shall either:

- (a) cancel the suspension order;
- (b) extend the suspension order for a specified time period not to exceed thirty (30) days; or
- (c) terminate the contract as provided herein.

The contractor shall resume performance once a suspension order issued under this section is canceled or expires. If as a result of the suspension of performance, there is a financial or schedule impact upon the contract, an appropriate adjustment may be made by, or with the approval of, the Judicial Purchasing Agent. Any adjustment shall be set forth in writing. After a suspension order has been canceled or expires, the contractor shall provide any request for adjustment to the Judicial Purchasing Agent within thirty (30) days after resuming work performance.

B. Termination of a Contract by the Judiciary

1. Termination for Default or Nonperformance

If, for any reason, the contractor breaches the contract by failing to satisfactorily fulfill or perform any obligations, promises, terms, or conditions, and having been given reasonable notice of and opportunity to cure such default, fails to take satisfactory corrective action within the time specified by the Judiciary, the Judiciary may terminate the contract, in whole or in part, the termination of all outstanding contracts or sub-contracts held by the contractor, and the suspension or debarment of the contractor from future procurements by giving written notice to the contractor specifying the date for termination. The Judiciary shall endeavor to provide such notice at least seven (7) calendar days before the effective date of the termination.

In the event of a termination for default or nonperformance, in whole or in part, the Judiciary may procure similar goods or services in a manner and upon terms it deems appropriate, and the contractor shall be liable for the excess costs incurred by the Judiciary as a result of the contractor's default. The contractor, or its surety, agrees to promptly reimburse the Judiciary for the excess costs, but shall have no claim to the difference should the replacement cost be less.

2. Termination Without Cause

The Judiciary may terminate the contract in whole or in part without cause at any time by giving written notice to the contractor of such termination at least thirty (30) days before the effective date of such termination. The notice shall specify the part(s) of the contract being terminated and the effective termination date.

Within thirty (30) days of the effective date of the termination of the contract the contractor shall compile and submit to the Judiciary an accounting of the work performed up to the date of termination. The Judiciary may consider the following claims in determining reasonable compensation owed to the contractor for work performed up to the date of termination:

- (a) contract prices for goods or services accepted under the contract;
- (b) costs incurred in preparing to perform and performing the terminated portion of the contract; or
- (c) any other reasonable costs incurred by the contractor as a result of the termination.

The total sum to be paid to the contractor shall not exceed the total contract price, less any payments previously made to the contractor, the proceeds from any sales of goods or manufacturing materials, and the contract price for work not terminated.

3. Contractor's Obligations in the Event of Termination

If the contract is terminated for any reason, or expires pursuant to its terms, the contractor shall transfer and deliver to the Judiciary in the manner and to the extent directed by the Judiciary:

- (a) all finished or unfinished material prepared by the contractor; and
- (b) all material, if any, provided to the contractor by the Judiciary.

For the purposes of the contract, "material" shall include, but is not limited to, goods, supplies, parts, tools, machinery, equipment, furniture, fixtures, information, data, reports, summaries, tables, maps, charts, photographs, studies, recommendations, files, audiotapes, videotapes, records, keys, security badges, and documents.

If the contract is terminated for cause, the contractor shall not be relieved of liability to the Judiciary for damages sustained because of any breach by the contractor. In such event, the Judiciary may retain any amounts which may be due and owing to the contractor until such time as the exact amount of damages due the Judiciary from the contractor has been determined by the Judicial Purchasing Agent. The Judiciary may also set off any damages so determined against the amounts retained.

Upon termination of the contract, the contractor shall stop performance on the date specified, terminate any outstanding orders and subcontracts applicable to the terminated portion of the contract, and shall incur no further commitments or obligations in connection with the terminated performance. The contractor shall settle all liabilities and claims arising out of the termination of subcontracts and order generating from the terminated performance. The Judiciary may direct the contractor to assign the contractor's right, title and interest under terminated orders or subcontracts to the Judiciary or a third party.

Terminations of Purchase Order Contracts or Master Pricing Agreements shall require the signature of the Judicial Purchasing Agent or his designee. Notice of termination by either party shall be submitted in writing to the other party in accordance with the termination clause of the contract, or where no specific termination clause is included, written notice shall be provided no later than thirty (30) days before the expiration of the contract.

Article XV. Presumption of Correctness and Finality of Determinations

Section 15.01 Decision Presumed To Be Correct

The decision of the Judicial Purchasing Committee or any official, agent, or other person designated by the Judiciary concerning any controversy arising under, or in connection with, the solicitation or award of a contract, shall be entitled to a presumption of correctness. The decision

shall not be disturbed unless it was: procured by fraud; in violation of constitutional or statutory provisions; in excess of the statutory authority of the agency; made upon unlawful procedure; affected by other error or law; clearly erroneous in view of the reliable, probative, and substantial evidence on the whole record; arbitrary; capricious; characterized by an abuse of discretion; or clearly unwarranted exercise of discretion.

Section 15.02 Finality of Determinations

The determinations required by Section 10.02(G) (Negotiations After Unsuccessful Competitive Sealed Bidding); Section 10.02(H)(3)(Protest Decision); Section 10.03 (Competitive Negotiations); Section 10.05 (Exceptions); and Article XI (Contractor Prequalification, Qualification and Solicitation) shall be final and conclusive unless they are clearly erroneous, arbitrary, capricious, or contrary to law.

Article XVI. Authority to Resolve Contract and Breach of Contract Controversies

Prior to the institution of arbitration or litigation concerning any contract, claim, or controversy, the Chief Purchasing Officer is authorized, subject to approval of the Judicial Purchasing Committee, to settle, compromise, pay, or otherwise adjust the claim by or against or controversy with, a contractor relating to a contract entered into by the Judiciary, including a claim or controversy based on contract, mistake, misrepresentation, or other cause for contract modification or rescission, but excluding any claim or controversy involving penalties or forfeitures prescribed by statute or regulation where an official other than the Chief Purchasing Officer is specifically authorized to settle or determine such controversy.

Article XVII. Dispute and Appeals Procedure

- Any person, firm, or corporation having a lawfully authorized written contract with the Judiciary may bring an action against the Judiciary on the contract, including, but not limited to actions either for breach of contract, enforcement of contract or for both.
- Any such claim shall be commenced in superior court within three (3) years from the date of completion specified in the contract and shall be tried by the court sitting without a jury. The case shall receive a priority position on the calendar. All defenses in law or equity, except the defense of governmental immunity, shall be preserved to the Judiciary.
- The court shall enter its findings as a judgment of the court and such judgment shall have the same effect and be enforceable as any other judgment of the court in civil cases, subject to the provisions of this chapter.
- Appeals may be taken to the supreme court under the same conditions and under the same practice as appeals are taken from judgments in civil cases rendered by the superior court.
- If damages awarded on any contract claim under this section exceed the original amount of the contract, the excess shall be limited to an amount which is equal to the amount of the original contract.
- No person, firm, or corporation shall be permitted more than one money recovery upon a claim for the enforcement of or for breach of contract with the Judiciary.

The Judiciary shall be immune from any liability that might be incurred as a result of exercising judicial purchasing power, and immune from liability for any and all damages sustained by any person, firm, corporation or entity as a result of good faith determinations made by any member of the Judicial Purchasing Office and/or its designee, in the course of its duties under these rules and regulations.

Article XVIII. Records

The Judiciary shall maintain records of all purchases and sales made under its authority and shall make periodic summary reports of all transactions to the State Court Administrator.

Section 18.01 Report of Noncompetitive Negotiations and Small Purchases

A summary shall be compiled annually by the Judicial Purchasing Agent, within ninety (90) days following the close of the fiscal year, of contracts made under Section 10.05 (Exceptions) during that preceding fiscal year. The summary shall name each contractor; shall state the amount and type of each contract, and shall be retained for a period of five (5) years and available for public inspection.

Article XIX. Grants

"Grants" shall mean monies provided by the Judiciary to or on behalf of individuals or entities to underwrite specific costs of services or programs. Although grants may be distributed for specific purposes, payment is not based upon supply of specific units of service or products.

The Judiciary may obtain services or provide programs on behalf of clients through grants to nonprofit or other entities; however, when the payment of "grant" funds is subject to the provision of services or programs, determination of contract award shall be obtained by a request for proposal procedure to obtain the advantages of competition.

Nonprofit status shall not automatically exempt organizations from being subject to competitive purchasing principles.

The Judiciary may utilize the Department of Administration's Office of Purchases to undertake Request for Proposal procedures; however, Judiciary representatives shall be responsible for assisting in the establishment of evaluation criteria and shall participate in the review and evaluation of responses to the Request for Proposal.

All grant contracts entered into by the Judiciary shall be subject to an audit of competitive practices.

Grants in the form of subsidies or general assistance shall be administered by the Judiciary in accordance with legal mandates restricting or defining the use of such funds.

Section 19.01 Grants Not Considered Procurements

The following grants shall not be considered procurements:

- Grants, subsidies, entitlements or benefits purchased.
- Grants in the form of subsidies or general assistance shall be administered by the Judiciary in accordance with legal mandates restricting or defining the use of such funds.
- Grants, subsidies, entitlements or benefits purchased on behalf of, or paid directly to, individuals. Examples include but shall not be limited to:
 - (a) transportation services - public bus, taxicab, ferry;
 - (b) education and recreation benefits;
 - (c) fees - tuition costs, registration; and
 - (d) medical, dental, food stamps, etc.

Section 19.02 Special Provisions and Requirements for Grants

A. Contracting Authority.

Judicial grantor directors may delegate contracting authority to enter into agreements for the purpose of distributing grants. Delegated contracting authority does not require the issuance of a purchase order.

Grants for the provision of programs, services, and facility improvements shall not be authorized without agreements or contracts which:

- specify the purpose for the grant;
- specify method and terms of payment;
- define service or product, if required;
- outline any legal limitations on the funding;
- set a time limit for distribution of funds;
- require maintenance of records for a specified period of time;
- provide for auditing; and
- provide for termination of the agreement/contract.

Article XX. Fixed Asset Management

The Judiciary will provide SFA12 (Report of Fixed Assets) information and follow the fixed asset thresholds for all assets as set forth by the Department of Administration, to be recorded in the State’s central fixed asset database. The Judiciary will use inventory tags supplied by the Department of Administration Office of Accounts and Control so as to effectuate the expedient processing of invoices relating to capital purchases.

Article XXI. Effective Date

The rules and regulations contained herein shall become effective when filed with the Secretary of State. They are to be considered a public record and available for public inspection.

Article XXII. Amendment and Suspension of Rules and Regulations

These rules and regulations, or any portion thereof, may be amended or rescinded by the State Court Administrator, with the approval of the Chief Justice, provided notice of the

substance of the proposed amendment is submitted in writing. The amendments, rescissions or suspension of rules shall become effective immediately upon filing with the Secretary of State in the same manner as the original rules.

Submitted by:

J. Joseph Baxter
State Court Administrator

With the approval of :

Frank J. Williams
Chief Justice

Dated:

APPENDIX A

<p style="text-align: center;">RHODE ISLAND JUDICIARY GENERAL TERMS AND CONDITIONS OF PURCHASE</p>
--

Preamble

The Judicial Purchasing Office may, from time to time, make amendments to the General Terms and Conditions when the Judicial Purchasing Agent determines that such amendments are in the best interest of the Judiciary. Amendments shall be made available for public inspection at the Office of the Secretary of State but shall not require formal public notice and hearing. Copies of the Terms and Conditions shall be provided to any individual or firm requesting to become a registered bidder. Applicants shall be required, as part of the application process, to certify that they have read the General Terms and Conditions and understand that they apply to all judicial purchases.

JUDICIAL PURCHASING OFFICE GENERAL CONDITIONS OF PURCHASE

All Judicial purchase orders, contracts, solicitations, delivery orders and service requests shall incorporate and be subject to the provisions of Rhode Island General Laws 8-15-4 and the judicial purchasing rules and regulations adopted pursuant thereto, all other applicable provisions of the Rhode Island General Laws, specific requirements described in the Request or Contract, and the following General Conditions of Purchase:

1. **GENERAL**

All purchase orders, contracts, solicitations, delivery orders, and service requests are for specified goods and services, in accordance with express terms and conditions of purchase, as defined herein. For the purposes of this document, the terms "bidder" and "contractor" refer to any individual, firm, corporation, or other entity presenting a proposal indicating a desire to enter into contracts with the Judiciary, or with whom a contract is executed by the Judicial Purchasing Agent, and the term "contractor" shall have the same meaning as "vendor".

2. **ENTIRE AGREEMENT**

The Judiciary's Purchase Order, or other Judiciary contract endorsed by the Judicial Purchasing Office, shall constitute the entire and exclusive agreement between the Judiciary and any contractor receiving an award. In the event any conflict between the bidder's standard terms of sale, these conditions or more specific provisions contained in the solicitation shall govern.

All communication between the Judiciary and any contractor pertaining to any award or contract shall be accomplished in writing.

a. Each proposal will be received with the understanding that the acceptance, in writing, by contract or Purchase Order by the Judicial Purchasing Agent of the offer to do work or to furnish any or all the materials, equipment, supplies or services described therein shall constitute a contract between the bidder and the Judiciary. This shall bind the bidder on his part to furnish and deliver at the prices and in accordance with the conditions of said accepted proposal and detailed specifications and the Judiciary on its part to order from such contractor (except in case of emergency) and to pay for at the agreed prices, all materials, equipment, supplies or services specified and delivered. A contract shall be deemed executory only to the

extent of funds available for payment of the amounts shown on Purchase Orders issued by the Judiciary to the contractors.

b. No alterations or variations of the terms of the contract shall be valid or binding upon the Judiciary unless submitted in writing and accepted by the Judicial Purchasing Agent. All orders and changes thereof must emanate from the Judicial Purchasing Office: no oral agreement or arrangement made by a contractor with an agency or employee will be considered to be binding on the Judicial Purchasing Agent, and may be disregarded.

c. Contracts will remain in force for the contract period specified or until all articles or services ordered before date of termination shall have been satisfactorily delivered or rendered and accepted and thereafter until all terms and conditions have been met, unless:

1. terminated prior to expiration date by satisfactory delivery against orders of entire quantities, or
2. extended upon written authorization of the Judicial Purchasing Agent and accepted by the contractor, to permit ordering of the unordered balances or additional quantities at the contract price and in accordance with the contract terms, or
3. canceled by the Judiciary in accordance with other provisions stated herein.

d. It is mutually understood and agreed that the contractor shall not assign, transfer, convey, sublet or otherwise dispose of this contract or his right, title or interest therein, or his power to execute such contract, to any other person, company or corporation, without the previous consent, in writing, of the Judicial Purchasing Agent.

e. If, subsequent to the submission of an offer or issuance of a purchase order or execution of a contract, the bidder or contractor shall merge with or be acquired by another entity, the contract may be terminated, except as a corporate resolution prepared by the contractor and the new entity ratifying acceptance of the original bid or contract terms, condition, and pricing is submitted to the Judicial Purchasing Office, and expressly accepted.

f. The contractor or bidder further warrants by submission of an offer or acceptance of a purchase order or other contract that he has no knowledge at the time of such action of any outstanding and delinquent or otherwise unsettled debt owed by him to the Judiciary, and agrees that later discovery by the Judicial Purchasing Agent that this warranty was given in spite of such knowledge, except where the matter is pending in hearing or from any appeal therefrom, shall form reasonable grounds for termination of the contract.

3. SUBCONTRACTS

No subcontracts or collateral agreements shall be permitted, except with the Judiciary's express written consent. Upon request, contractors must submit to the Judicial Purchasing Office a list of all subcontractors to be employed in the performance of any Purchase Order or other contract arising from this Request.

4. RELATIONSHIP OF PARTIES

The contractor or bidder warrants, by submission of an offer or acceptance of a purchase order or other contract, that he is not an employee, agent, or servant of the Judiciary, and that he is fully qualified and capable in all material regards to provide the specified goods and services. Nothing herein shall be construed as creating any contractual relationship or obligation between

the Judiciary and any sub-bidder, subcontractor, supplier, or employee of the contractor or offeror.

5. COSTS OF PREPARATION

All costs associated with the preparation, development, or submission of bids or other offers will be borne by the offeror. The Judiciary will not reimburse any offeror for such costs.

6. SPECIFIED QUANTITY REQUIREMENT

Except where expressly specified to the contrary, all solicitations and contracts are predicated on a specified quantity of goods or services, or for a specified level of funding.

a. The Judiciary reserves the right to modify the quantity, scope of service, date of delivery or completion, or funding of any contract, with no penalty or charge, by written notice to the contractor, except where alternate terms have been expressly made a part of the contract.

b. The Judiciary shall not accept quantities in excess of the specified quantity except where the item is normally sold by weight (where sold by weight, the Judiciary will not accept quantities greater than ten per cent [10%] of the specified quantity), or where the Request or Contract provides for awards for other than exact quantities.

c. Purchase Orders or other contracts may be increased in quantity or extended in term without subsequent solicit with the mutual consent of the contractor and the Judiciary, where determined by the Judicial Purchasing Agent to be in the Judiciary's best interest.

7. TERM AND RENEWAL

Where offers have been requested or contracts awarded for terms exceeding periods of twelve (12) months, it is mutually understood and agreed that the Judiciary's commitment is limited to a base term not to exceed twelve (12) months, subject to renewal annually at the Judiciary's sole option for successive terms as otherwise described, except where expressly specified to the contrary. Purchase orders appearing to commit to obligations of funding or terms of performance may be executed for administrative convenience, but are otherwise subject to this provision, and in such cases the Judiciary's renewal shall be deemed to be automatic, conditional on the continued availability of appropriated funds for the purpose, except as written notice of the Judiciary's intent not to renew is served.

8. DELIVERY/COMPLETION

Delivery must be made as ordered and/or projects completed in accordance with the proposal. If delivery qualifications do not appear on the bidder's proposal, it will be interpreted to mean that goods are in stock and that shipment will be made within seven (7) calendar days. If the project completion date is not specified in the proposal, the date shall be determined by the Judicial Purchasing Agent. The decision of the Judicial Purchasing Agent, as to reasonable compliance with the delivery terms, and date of completion shall be final. Burden of proof of delay in receipt of order shall rest with the contractor. No delivery charges shall be added to invoices except when authorized on the Purchase Order.

9. FOREIGN CORPORATIONS

In accordance with Title 7 Chapter 1.1 (“Business Corporations”) of the General Laws of Rhode Island, no foreign corporation shall have the right to transact business in this state until it shall have procured a certificate of authority so to do from the Secretary of State.

10. PRICING

All pricing offered or extended to the Judiciary is considered to be firm and fixed unless expressly provided for to the contrary. All prices shall be quoted F.O.B. Destination with freight costs included in the unit cost to be paid by the Judiciary, except, where the Request or Contract permits, offers reflecting F.O.B. Shipping Point will be considered, and freight costs may then be prepaid and added to the invoice.

11. COLLUSION

Bidder or contractor warrants that he has not, directly or indirectly, entered into any agree participated in any collusion or otherwise taken any action in restraint of full competitive bidding. In special circumstances, an executed affidavit will be required as a part of the bid.

12. PROHIBITION AGAINST CONTINGENT FEES AND GRATUITIES

Bidder or contractor warrants that he has not paid, and agrees not to pay, any bonus, commission, fee, or gratuity to any employee or official of the Judiciary for the purpose of obtaining any contract or award issued by the Judiciary. Bidder or contractor further warrants that no commission or other payment has been or will be received from or paid to any third party contingent on the award of any contract by the Judiciary, except as shall have been expressly communicated to the Judicial Purchasing Agent in writing prior to acceptance of the contract or award in question. Subsequent discovery by the Judiciary of non-compliance with these provisions shall constitute sufficient cause for immediate termination of all outstanding contracts and suspension or debarment of the bidder(s) or contractor(s) involved.

13. AWARDS

Awards will be made with reasonable promptness and by written notice to the successful bidder (only); bids are considered to be irrevocable for a period of sixty (60) days following the bid opening unless expressly provided for to the contrary in the Request, and may not be withdrawn during this period without the express permission of the Judicial Purchasing Agent.

a. Awards shall be made to the bidder(s) whose offer(s) constitutes the lowest responsive price offer (or lowest responsive price offer on an evaluated basis) for the item(s) in question or for the Request as a whole, at the option of the Judiciary. The Judiciary reserves the right to determine those offers which are responsive to the Request, or which otherwise serve its best interests.

b. The Judiciary reserves the right, before making award, to initiate investigations as to whether or not the materials, equipment, supplies, qualifications or facilities offered by the bidder meet the requirements set forth in the proposal and specification, and are ample and sufficient to insure the proper performance of the contract in the event of award. If upon such examination it is found that the conditions of the proposal are not complied with or that articles or equipment proposed to be furnished do not meet the requirements called for, or that the qualifications or facilities are not satisfactory, the Judiciary may reject such a bid. It is distinctly understood, however, that nothing in the foregoing shall mean or imply that it is obligatory upon

the Judiciary to make any examinations before awarding a contract; and it is further understood that if such examination is made, it in no way relieves the contractor from fulfilling all requirements and conditions of the contract.

c. Qualified or conditional offers which impose limitations of the bidder's liability or modify the requirements of the bid, offers for alternate specifications, or which are made subject to different terms and conditions than those specified by the Judiciary may, at the option of the Judiciary, be

1. rejected as being non-responsive, or
2. set aside in favor of the Judiciary's terms and conditions (with the consent of the bidder), or
3. accepted, where the Judicial Purchasing Agent determines that such acceptance best serves the interests of the Judiciary.

Acceptance or rejection of alternate or counter-offers by the Judiciary shall not constitute a precedent which shall be considered to be binding on successive solicitations or procurements.

d. Bids submitted in pencil, or which do not bear an original signature, in ink, by an owner or authorized agent thereof, will not be accepted.

e. Bids must be extended in the unit of measure specified in the Request. In the event of any discrepancy between unit prices and their extensions, the unit price will govern.

f. The Judicial Purchasing Agent reserves the right to determine the responsibility of any bidder for a particular procurement.

g. The Judicial Purchasing Agent reserves the right to reject any and all bids in whole or in part, to waive technical defects, irregularities, and omissions, and to give consideration to past performance of the offerors where, in his judgment the best interests of the Judiciary will be served by so doing.

h. The Judicial Purchasing Agent reserves the right to make awards by items, group of items or on the total low bid for all the items specified as indicated in the detailed specification, unless the bidder specifically indicates otherwise in his bid.

i. Preference may be given to bids on products raised or manufactured in the State of Rhode Island, other things being equal.

j. The impact of discounted payment terms shall not be considered in evaluating responses to any Request.

k. The Judicial Purchasing Agent reserves the right to act in the Judiciary's best interests regarding awards caused by clerical errors by the Judicial Purchasing Office.

14. SUSPENSION AND DEBARMENT

The Judicial Purchasing Agent may suspend or debar any vendor or potential bidder, for good cause shown:

a. A debarment or suspension against a part of a corporate entity constitutes debarment or suspension of all of its divisions and all other organizational elements, except where the action has been specifically limited in scope and application, and may include all known corporate affiliates of a contractor, when such offense or act occurred in connection with the affiliate's performance of duties for or on behalf of the contractor, or with the knowledge, approval, or acquiescence of the contractor or one or more of its principals or directors (or where the contractor otherwise participated in, knew of, or had reason to know of the acts).

b. The fraudulent, criminal or other serious improper conduct of any officer, director, shareholder, partner, employee, or any other individual associated with a contractor may be imputed to the contractor when the conduct occurred in connection with the individual's performance of duties for or on behalf of the contractor, or with the contractor's knowledge, approval or acquiescence. The contractor's acceptance of benefits derived from the conduct shall be evidence of such knowledge, approval, or acquiescence.

c. A vendor or contractor who knowingly engages as a subcontractor for a contract awarded by the Judiciary to a vendor or contractor then under a ruling of suspension or debarment by the Judiciary shall be subject to disallowance of cost, annulment or termination of award, issuance of a stop work order, or debarment or suspension, as may be judged to be appropriate by the Judicial Purchasing Agent.

15. PUBLIC RECORDS

Contractors and bidders are advised that certain documents, correspondence, and other submissions to the Judicial Purchasing Office may be voluntarily made public by the Judiciary absent specific notice that portions of such submittals may contain confidential or proprietary information, such that public access to those items should be withheld.

16. PRODUCT EVALUATION

In all specifications, the words "or equal" are understood after each article when manufacturer's name or catalog are referenced. If bidding on items other than those specified, the bidder must, in every instance, give the trade designation of the article, manufacturer's name and detailed specifications of the item the bidder proposes to furnish; otherwise, the bid will be construed as submitted on the identical commodity described in the detailed specifications. The Judicial Purchasing Agent reserves the right to determine whether or not the item submitted is the approved equal the detailed specifications.

a. Any objections to specifications must be filed by a bidder, in writing, with the Judicial Purchasing Agent at least 96 hours before the time of bid opening to enable the Judicial Purchasing Office to properly investigate the objections.

b. All standards are minimum standards except as otherwise provided for in the Request or Contract.

c. Samples must be submitted to the Judicial Purchasing Office in accordance with the terms of the proposals and detailed specifications. Samples must be furnished free of charge and must be accompanied by descriptive memorandum invoices indicating whether or not the bidder desires their return and specifying the address to which they are to be returned (at the bidder's risk and expense), provided they have not been used or made useless by tests; and absent instructions, the samples shall be considered to be abandoned. Award samples may be held for comparison with deliveries.

d. All samples submitted are subject to test by any laboratory the Judicial Purchasing Agent may designate.

17. PRODUCT ACCEPTANCE

All merchandise offered or otherwise provided shall be new, of prime manufacture, and of first quality unless otherwise specified by the Judiciary. The Judiciary reserves the right to reject all nonconforming goods, and to cause their return for credit or replacement, at the

Judiciary's option. Contract deliverables specified for procurements of services shall be construed to be work products, and subject to the provisions of this section.

a. Failure by the Judiciary to discover latent defect(s) or concealed damage or non-conformance shall not foreclose the Judiciary's right to subsequently reject the goods in question.

b. Formal or informal acceptance by the Judiciary of non-conforming goods shall not constitute a precedent for successive receipts or procurements.

c. Where the contractor fails to promptly cure the defect or replace the goods, the Judiciary reserves the right to cancel the Purchase Order, contract with a different contractor, and to invoice the original contractor for any differential in price over the original contract price.

d. When materials, equipment or supplies are rejected, the same must be removed by the contractor from the premises of the Judiciary within forty-eight (48) hours of notification. Rejected items left longer than two days will be regarded as abandoned and the Judiciary shall have the right to dispose of them as its own property.

18. PRODUCT WARRANTIES

All product or service warranties normally offered by the contractor or bidder shall accrue to the Judiciary's benefit, in addition to any special requirements which may be imposed by the Judiciary. Every unit delivered must be guaranteed against faulty material and workmanship for a period of one year unless otherwise specified, and the Judiciary may, in the event of failure, order its replacement, repair, or return for full credit, at its sole option.

19. PAYMENT

Unless otherwise provided for by the Request or Contract, payment shall not be made until delivery has been made, or services performed, in full, and accepted. Payment shall not be due prior to thirty (30) working days following the latest of completion, acceptance, or the rendering of a properly submitted invoice.

a. Payment terms other than the foregoing may be rejected as being nonresponsive.

b. No partial shipments, or partial completion will be accepted, unless provided for by the Request or Contract.

c. Where a question of quality is involved, or failure to complete a project by the specified due date, payment in whole or part against which to charge back any adjustment required, shall be withheld at the direction of the Judicial Purchasing Agent. In the event a cash discount is stipulated, the withholding of payments, as herein described, will not deprive the Judiciary from taking such discount.

d. Payments for used portion of inferior delivery or late delivery will be made by the Judiciary on an adjusted price basis.

e. Payments on contracts under architectural or engineering supervision must be accompanied by a Certificate of Payment and Statement of Account signed by the architect or engineer and submitted to the Judicial Purchasing Office for approval.

20. THIRD PARTY PAYMENTS

The Judiciary recognizes no assigned or collateral rights to any purchase agreement except as may be expressly provided for in the bid or contract documents, and will not accede to any request for third party or joint payment(s), except as provided for in specific orders by a court of competent jurisdiction, or by express written permission of the Judicial Purchasing

Agent. Where an offer is contingent upon such payment(s), the offeror is obligated to serve affirmative notice in his bid submission.

21. SET-OFF AGAINST PAYMENTS

Payments due the contractor may be subject to reduction equal to the amount of unpaid and delinquent state taxes (or other just debt owed to the State), except where notice of delinquency has not been served or while the matter is pending in hearing or from any appeal therefrom.

22. CLAIMS

Any claim against a contractor may be deducted by the Judiciary from any money due him in the same or other transactions. If no deduction is made in such fashion, the contractor shall pay the Judiciary the amount of such claim on demand. Submission of a voucher and payment, thereof, by the Judiciary shall not preclude the Judicial Purchasing Agent from demanding a price adjustment in any case when the commodity delivered is later found to deviate from the specifications and proposal.

a. The Judicial Purchasing Agent may assess dollar damages against a vendor or contractor determined to be non-performing or otherwise in default of their contractual obligations equal to the cost of remedy incurred by the Judiciary, and make payment of such damages a condition for consideration for any subsequent award. Failure by the vendor or contractor to pay such damages shall constitute just cause for disqualification and rejection, suspension, or debarment.

23. CERTIFICATION OF FUNDING

The Chief Purchasing Officer shall provide certification as to the availability of funds to support the procurement for the current fiscal year ending June 30th only. Where delivery or service requirements extend beyond the end of the current fiscal year, such extensions are subject to both the availability of appropriated funds and a determination of continued need.

24. UNUSED BALANCES

Unless otherwise specified, all unused Blanket Order quantities and/or unexpended funds shall be automatically canceled on the expiration of the specified term. Similarly, for orders encompassing more than one fiscal year, unexpended balances of funding allotted for an individual fiscal year may be liquidated at the close of that fiscal year, at the Judiciary's sole option.

25. MINORITY BUSINESS ENTERPRISES

Pursuant to the provisions of Title 37 Chapter 14.1 of the General Laws, the Judiciary reserves the right to apply additional consideration to offers, and to direct awards to bidders other than the responsive bid representing the lowest price where:

a. the offer is fully responsive to the terms and conditions of the Request, and
b. the price offer is determined to be within a competitive range (not to exceed 5% higher than the lowest responsive price offer) for the product or service, and
c. the firm making the offer has been certified by the R.I. Department of Economic Development to be a small business concern meeting the criteria established to be considered a Minority Business Enterprise. Ten per cent [10%] of the dollar value of the work performed

against contracts for construction exceeding \$5,000 shall be performed by Minority Business Enterprises where it has been determined that subcontract opportunities exist, and where certified Minority Business Enterprises are available. A contractor may count towards its MBE, DBE, or WBE goals 60% of its expenditures for materials and supplies required under a contract and obtained from an MBE, DBE, or WBE regular dealer, and 100% of such expenditures when obtained from an MBE, DBE, or WBE manufacturer. Awards of this type shall be subject to approval, by the Chief Purchasing Officer, of a Subcontracting Plan submitted by the bidder receiving the award.

26. PREVAILING WAGE REQUIREMENT

In accordance with Title 37 Chapter 13 of the General Laws of Rhode Island, payment of the general prevailing rate of per diem wages and the general prevailing rate for regular, overtime and other working conditions existing in the locality for each craft, mechanic, teamster, or type of workman needed to execute this work is a requirement for both contractors and subcontractors for all public works.

27. EQUAL OPPORTUNITY COMPLIANCE, HANDICAPPED ACCESS AND AFFIRMATIVE ACTION

Contractors of the Judiciary are required to demonstrate the same commitment to equal opportunity as prevails under federal contracts controlled by Federal Executive Orders 11246, 11625, 11375 and 11830, and Title 28 Chapter 5.1 of the General Laws of Rhode Island.

Affirmative action plans shall be submitted by the contractor for review by the State Equal Opportunity Office. A contractor's failure to abide by the rules, regulations, contract terms and compliance reporting provisions as established shall be grounds for forfeiture and penalties as shall be established, including but not limited to suspension.

28. DRUG-FREE WORKPLACE REQUIREMENT

Contractors who do business with the Judiciary and their employees shall abide by the State's drug-free workplace policy and the contractor shall so attest by signing a certificate of compliance.

29. TAXES

The Judiciary is exempt from payment of excise, transportation and sales tax imposed by the Federal or State Government. These taxes should not be included in the proposal price. Exemption Certificates will be furnished upon request.

30. INSURANCE

All construction contractors, independent tradesmen, or firms providing any type of maintenance, repair, or other type of service to be performed on judicial premises, buildings, or grounds are required to purchase and maintain coverage with a company or companies licensed to do business in the state as follows:

- a. Comprehensive General Liability Insurance
 - 1) Bodily Injury \$1,000,000 each occurrence/ \$1,000,000 annual aggregate
 - 2) Property Damage \$500,000 each occurrence /\$500,000 annual aggregate
- Independent Contractors

- Contractual - including construction hold harmless and other types of contracts or agreements in effect for insured operations
- Completed Operations
- Personal Injury (with employee exclusion deleted)
- b. Automobile Liability Insurance
 - Combined Single Limit \$1,000,000 each occurrence
 - Bodily Injury
 - Property Damage, and in addition non-owned and/or hired vehicles and equipment
- c. Workers' Compensation Insurance
 - Coverage B \$100,000

The Judicial Purchasing Agent reserves the right to consider and accept alternate forms and plans of insurance or to require additional or more extensive coverage for any individual requirement. Successful bidders shall provide certificates of coverage, reflecting the Rhode Island Judiciary as an additional insured, to the Judicial Purchasing Office, forty-eight (48) hours prior to the commencement of work, as a condition of award. Failure to comply with this provision shall result in rejection of the offeror's bid.

31. BID SURETY

When requested, a bidder must furnish a Bid Bond or Certified Check for 5% of his bid, or for the stated amount shown in the solicitation. Bid Bonds must be executed by a reliable Surety Company authorized to do business in the State of Rhode Island. Failure to provide Bid Surety with bid may be cause for rejection of bid. The Bid Surety of any three bidders in contention will be held until an award has been made according to the specifications of each proposal. All others will be returned by mail within 48 hours following the bid opening. Upon award of a contract, the remaining sureties will be returned by mail unless instructed to do otherwise.

32. PERFORMANCE AND LABOR AND PAYMENT BONDS

A performance bond and labor and payment bond of up to 100% of an award may be required by the Judicial Purchasing Agent. Bonds must meet the following requirements:

- a. Corporation: The Bond must be signed by an official of the corporation above his/her official title and the corporate seal must be affixed over his/her signature.
- b. Firm or Partnership: The Bond must be signed by all of the partners and must indicate that they are "Doing Business As (name of firm)."
- c. Individual: The Bond must be signed by the individual owning the business and indicate "Owner."
- d. The Surety Company executing the Bond must be licensed to do business in the State of Rhode Island or Bond must be countersigned by a company so licensed.
- e. The Bond must be signed by an official of the Surety Company and the corporate seal must be affixed over his signature.
- f. Signatures of two witnesses for both the principal and the Surety must appear on the Bond.
- g. A Power of Attorney for the official signing of the Bond for the Surety Company must be submitted with the Bond.

33. SUSPENSION, DEFAULT AND TERMINATION

a. Suspension of a Contract by the Judiciary

The Judiciary reserves the right at any time and for any reason to suspend all or part of this contract, for a reasonable period, not to exceed sixty days, unless the parties agree to a longer period. The Judiciary shall provide the contractor with written notice of the suspension order signed by the Purchasing Agent or his or her designee, which shall set forth the date upon which the suspension shall take effect, the date of its expiration, and all applicable instructions. Upon receipt of said order, the contractor shall immediately comply with the order and suspend all work under this contract as specified in the order. The contractor shall take all reasonable steps to mitigate costs and adverse impact to the work specified in the contract during the suspension period. Before the order expires, the Judiciary shall either:

1. cancel the suspension order;
2. extend the suspension order for a specified time period not to exceed thirty (30) days; or
3. terminate the contract as provided herein.

The contractor shall resume performance once a suspension order issued under this section is canceled or expires. If as a result of the suspension of performance, there is a financial or schedule impact upon the contract, an appropriate adjustment may be made by, or with the approval of, the Judicial Purchasing Agent. Any adjustment shall be set forth in writing. After a suspension order has been canceled or expires, the contractor shall provide any request for adjustment to the Judicial Purchasing Agent within thirty (30) days after resuming work performance.

b. Termination of a Contract by the Judiciary

1. Termination for Default or Nonperformance

If, for any reason, the contractor breaches the contract by failing to satisfactorily fulfill or perform any obligations, promises, terms, or conditions, and having been given reasonable notice of and opportunity to cure such default, fails to take satisfactory corrective action within the time specified by the Judiciary, the Judiciary may terminate the contract, in whole or in part, the termination of all outstanding contracts or sub-contracts held by the contractor, and the suspension or debarment of the contractor from future procurements by giving written notice to the contractor specifying the date for termination. The Judiciary shall endeavor to provide such notice at least seven (7) calendar days before the effective date of the termination.

A contractor who fails to commence within the time specified or complete an award made for repairs, alterations, construction, or any other service will be considered in default of contract. If contractor consistently fails to deliver quantities or otherwise perform as specified, the Judicial Purchasing Agent reserves the right to terminate the contract and contract for completion of the work with another contractor and seek recourse from the defaulting contractor or his surety. In the event of a termination for default or nonperformance, in whole or in part, the Judiciary may procure similar goods or services in a manner and upon terms it deems appropriate, and the contractor shall be liable for the excess costs incurred by the Judiciary as a result of the contractor's default. The contractor, or its surety, agrees to promptly reimburse the

Judiciary for the excess costs, but shall have no claim to the difference should the replacement cost be less.

2. Termination Without Cause

The Judiciary may terminate the contract in whole or in part without cause at any time by giving written notice to the contractor of such termination at least thirty (30) days before the effective date of such termination. The notice shall specify the part(s) of the contract being terminated and the effective termination date.

Within thirty (30) days of the effective date of the termination of the contract the contractor shall compile and submit to the Judiciary an accounting of the work performed up to the date of termination. The Judiciary may consider the following claims in determining reasonable compensation owed to the contractor for work performed up to the date of termination:

- (a) contract prices for goods or services accepted under the contract;
- (b) costs incurred in preparing to perform and performing the terminated portion of the contract; or
- (c) any other reasonable costs incurred by the contractor as a result of the termination.

The total sum to be paid to the contractor shall not exceed the total contract price, less any payments previously made to the contractor, the proceeds from any sales of goods or manufacturing materials, and the contract price for work not terminated.

3. Contractor's Obligations in the Event of Termination

If the contract is terminated for any reason, or expires pursuant to its terms, the contractor shall transfer and deliver to the Judiciary in the manner and to the extent directed by the Judiciary:

- all finished or unfinished material prepared by the contractor; and
- all material, if any, provided to the contractor by the Judiciary.

For the purposes of the contract, "material" shall include, but is not limited to, goods, supplies, parts, tools, machinery, equipment, furniture, fixtures, information, data, reports, summaries, tables, maps, charts, photographs, studies, recommendations, files, audiotapes, videotapes, records, keys, security badges, and documents.

If the contract is terminated for cause, the contractor shall not be relieved of liability to the Judiciary for damages sustained because of any breach by the contractor. In such event, the Judiciary may retain any amounts which may be due and owing to the contractor until such time as the exact amount of damages due the Judiciary from the contractor has been determined by the Judicial Purchasing Agent. The Judiciary may also set off any damages so determined against the amounts retained.

Upon termination of the contract, the contractor shall stop performance on the date specified, terminate any outstanding orders and subcontracts applicable to the terminated portion of the contract, and shall incur no further commitments or obligations in connection with the terminated performance. The contractor shall settle all liabilities and claims arising out of the termination of subcontracts and order generating from the terminated performance. The Judiciary may direct the contractor to assign the contractor's right, title and interest under terminated orders or subcontracts to the Judiciary or a third party.

Terminations of Purchase Order Contracts or Master Pricing Agreements shall require the signature of the Judicial Purchasing Agent or his designee. Notice of termination by either party shall be submitted in writing to the other party in accordance with the termination clause of the contract, or where no specific termination clause is included, written notice shall be provided no later than thirty (30) days before the expiration of the contract.

34. INDEMNITY

The contractor guarantees:

a. To save the Judiciary, its agents and employees, harmless from any liability imposed upon the Judiciary arising from the negligence, either active or passive, of the contractor, as well as for the use of any copyrighted or uncopyrighted composition, secret process, patented or unpatented invention, article or appliance furnished or used in the performance of the contract of which the contractor is not the patentee, assignee or licensee.

b. To pay for all permits, licenses and fees and give all notices and comply with all laws, ordinances, rules and regulations of the city or town in which the installation is to be made and of the State of Rhode Island.

c. That the equipment offered is standard new equipment, latest model of regular stock product with all parts regularly used with the type of equipment offered; also, that no attachment or part has been substituted or applied contrary to manufacturer's recommendations and standard practice.

35. CONTRACTOR'S OBLIGATIONS

In addition to the specific requirements of the contract, construction and building repair contractors bear the following standard responsibilities:

a. To furnish adequate protection from damage for all work and to repair damages of any kind, for which he or his workmen are responsible, to the building or equipment, to his own work, or to the work of other contractors;

b. The contractor, its subcontractor(s) and their employees and/or agents, shall protect and preserve property in the contractor or subcontractor's possessions in which the Judiciary has an interest, and any and all materials provided to the contractor or subcontractor by the Judiciary;

c. To clear and remove all debris and rubbish resulting from his work from time to time, as directed or required, a completion of the work leave the premises in a neat unobstructed condition, broom clean, and in satisfactory order and repair;

d. To store equipment, supplies, and material at the site only upon approval by the Judiciary, and at his own risk;

e. To perform all work so as to cause the least inconvenience to the Judiciary, and with proper consideration for the rights of other contractors and workmen;

f. To acquaint themselves with conditions to be found at the site, and to assume responsibility for the appropriate dispatching of equipment and supervision of his employees during the conduct of the work;

g. To ensure that his employees are instructed with respect to special regulations, policies, and procedures in effect for any judicial facility or site, and that they comply with such rules, including but not limited to security policies or practices and/or criminal background checks for any employees and/or subcontractors;

h. The contractor shall ensure that its employees or agents are experienced and fully qualified to engage in the activities and services required under the contract;

i. The contractor shall ensure that at all times while services are being performed under this contract at least one of its employees or agents on the premises has a good command of the English language and can effectively communicate with the Judiciary and its staff;

j. The contractor and contractor's employees or agents shall comply with all applicable licensing and operating requirements required by federal or state law and shall meet accreditation and other generally accepted standards of quality in the applicable field of activity;

k. The contractor shall secure and retain all employee-related insurance coverage for its employees and agents as required by law; and

l. The contractor, subcontractor, and his or her employees and agents shall not disclose any confidential information of the Judiciary to a third party. Confidential information means:

- (1) any information of a sensitive or proprietary nature, whether or not specially identified as confidential or proprietary; or
- (2) any information about the Judiciary gained during the performance of a contract that is not already lawfully in the public domain.

36. FORCE MAJEURE

All orders shall be filled by the contractor with reasonable promptness, but the contractor shall not be held responsible for any losses resulting if the fulfillment of the terms of the contract shall be delayed or prevented by wars, acts of public enemies, strikes, fires, floods, acts of God, or for any other acts not within the control of the contractor and which by the exercise of reasonable diligence, the contractor is unable to prevent.

McGRATH JUDICIAL COMPLEX FIRE ALARM UPGRADES

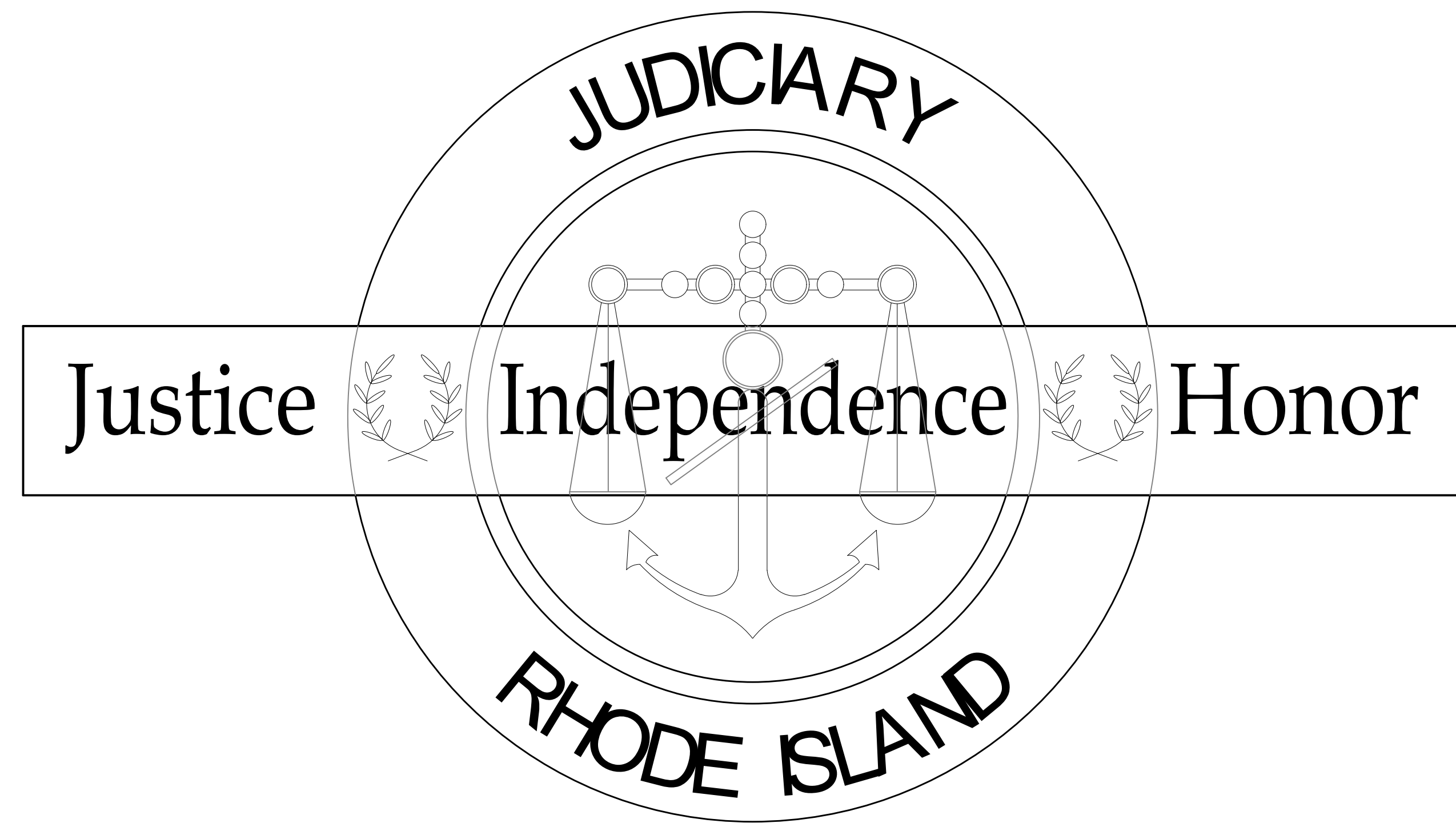

4800 TOWER HILL ROAD,
WAKEFIELD, RHODE ISLAND

JANUARY 30, 2020

Edward Rowse ARCHITECTS

400 Massasoit Avenue
Suite 300, Second Floor
East Providence, Rhode Island
p. (401) 331-9200
f. (401) 331-9270

2 Hampshire Street
Suite 106, First Floor
Foxboro, Massachusetts
p. (774) 215-0290
f. (774) 215-0497

e-mail: rowse@rowsearch.com

Building Engineering Resources
Consultants in Mechanical, Electrical, Plumbing, & Fire Protection
Engineering



100 Midway Road - Suite 23
Cranston, RI 02920
p. (401) 942-3500
f. (401) 228-6205
ber@ber-engineering.com



McGRATH JUDICIAL COMPLEX
4800 TOWER HILL ROAD, WAKEFIELD, RI

LIST OF DRAWINGS

TITLE SHEET	1 OF 6
ELECTRICAL	
E0.01 ELECTRICAL LEGEND, FIXTURE SCHEDULE AND NOTES	2 OF 6
ED1.00 LOWER LEVEL FIRE ALARM DEMOLITION PLAN	3 OF 6
ED1.01 FIRST FLOOR FIRE ALARM DEMOLITION PLAN	4 OF 6
E1.00 LOWER LEVEL FIRE ALARM PLAN	5 OF 6
E1.01 FIRST FLOOR FIRE ALARM PLAN	6 OF 6

Edward Rowse
ARCHITECTS
400 Massasoit Avenue
Suite 300, Second Floor
East Providence, Rhode Island
p. (401) 331-9200
f. (401) 331-9270
e-mail: rowse@rowsearch.com

McGRATH JUDICIAL COMPLEX
FIRE ALARM UPGRADES
4800 TOWER HILL ROAD, WAKEFIELD, RHODE ISLAND

SET NUMBER
MAY 31, 2019

LEGEND

- MOUNTING HEIGHTS SHALL BE AS INDICATED UNLESS SHOWN OTHERWISE ON ELECTRICAL DRAWINGS OR ARCHITECTURAL ELEVATIONS
- ALL SYMBOLS MAY NOT BE SHOWN ON PLANS

RACEWAYS AND WIRING

- P4-1,3,5 SINGLE PHASE HOMERUNS TO PANELBOARD. "P4" DENOTES PANEL "1,3,5" DENOTES CIRCUIT NUMBERS. (3) 20A, 1P CIRCUITS NUMBER OF SLASH MARKS DENOTES NUMBER OF #12AWG CONDUCTORS IN MINIMUM 3/4" CONDUIT UNLESS OTHERWISE INDICATED.
- P4-2 MULTI-POLE HOMERUN TO PANELBOARD. "P4" DENOTES PANEL, "2" DENOTES CIRCUIT NUMBER, 20 AMP 3 POLE C/B. NUMBER OF SLASH MARKS DENOTES NUMBER OF #12AWG CONDUCTORS IN MINIMUM 3/4" CONDUIT.
- NOTES:
 - GREEN GROUND CONDUCTOR NOT INDICATED BUT SHALL BE INCLUDED IN EACH RACEWAY. SIZE SHALL BE #12AWG UNLESS OTHERWISE.
- 2#10,#100 EMERGENCY ONLY WIRING

RECEPTACLES (MOUNTED 18" AFF OR AS INDICATED ON ARCHITECTURAL PLANS)

- IC 2 DUPLEX RECEPTACLE. "2" DENOTES CIRCUIT NUMBER, "02" DENOTES GROUND FAULT CIRCUIT INTERRUPTER TYPE DEVICE, "IC" DENOTES ISOLATED GROUND TYPE DEVICE, "WP" DENOTES WEATHER PROOF COVER

FIRE ALARM SYSTEM

- MANUAL PULL STATION MOUNTED 48" AFF
- AUDIO/VISUAL ALARM MOUNTED 80" AFF. "C" DENOTES CEILING MOUNTED
- VISUAL ONLY UNIT MOUNTED 80" AFF.
- PHOTOELECTRIC SMOKE DETECTOR: "I" DENOTES IONIZATION SMOKE DETECTOR
- COMBINATION PHOTOELECTRIC SMOKE DETECTOR/CARBON MONOXIDE DETECTOR
- 135° FIXED TEMPERATURE HEAT DETECTOR. "190°" INDICATES 190°F FIXED TEMPERATURE
- DUCT MOUNTED SMOKE DETECTOR WITH SAMPLING TUBE
- REMOTE TEST STATION FOR DUCT SMOKE DETECTOR WITH NAMEPLATE LABELED ACCORDINGLY
- REMOTE ALARM INDICATOR
- FIRE ALARM CONTROL PANEL
- FIRE ALARM REMOTE ANNUNCIATOR
- NOTIFICATION APPLIANCE POWER SUPPLY PANEL
- ADDRESSABLE CONTROL MODULE
- ADDRESSABLE MONITOR MODULE
- ISOLATION MODULE
- DELAYED EGRESS DOOR RELAY
- REMOTE MOUNTED FIRE ALARM SYSTEM DRILL SWITCH. COORDINATE THE EXACT LOCATION WITH THE ARCHITECT PRIOR TO INSTALLING.
- RADIO MASTER BOX AES CORPORATION #7707P-88-ULP-M INTELLIGENT 2.0 FIRE SUBSCRIBER WITH #77-FACPA BATTERY, ALARM-SAF-AS-PSS AUXILIARY POWER SUPPLY, TWO (2) 12 A/H SEALED LEAD ACID BATTERIES AND A EXTERNAL HIGH GAIN FIBER GLASS ANTENNA KIT LITE.
- EXISTING TO BE REMOVED FIRE ALARM MASTER BOX
- EXISTING TO BE REUSED EXTERIOR FIRE ALARM BEACON
- EXISTING TO BE REUSED FIRE DEPARTMENT KEY REPOSITORY BOX
- EXISTING TO BE REUSED SPRINKLER TAMPER SWITCH
- EXISTING TO BE REUSED SPRINKLER WATER FLOW SWITCH

MISCELLANEOUS

- JUNCTION BOX, SIZED PER NEC
- GROUND

MECHANICAL EQUIPMENT TAG ABBREVIATIONS

- AN 1 DENOTES EQUIPMENT TYPE
- 1 DENOTES UNIT NUMBER
- ACC AIR-COOLED CONDENSER
- AHU AIR HANDLING UNIT
- B BOILER
- CH CHILLER
- CUH CABINET UNIT HEATER
- EBB ELECTRIC BASEBOARD
- EF EXHAUST FAN
- EH EXHAUST HOOD
- EWH ELECTRIC WALL HEATER
- FC FAN COIL
- HP HEAT PUMP
- MAU MAKE-UP AIR UNIT
- P PUMP
- RTU ROOF TOP UNIT
- UH UNIT HEATER
- VAV VARIABLE AIR VOLUME BOX
- WH ELECTRIC WATER HEATER

ABBREVIATIONS

- 3R NEMA 3R RATING
- 4X NEMA 4X RATING
- A AMPERES
- AFB ABOVE FINISHED FLOOR
- AFG ABOVE FINISHED GRADE
- ACC AMPERE INTERRUPTING CAPACITY
- ARCH ARCHITECT
- AWG AMERICAN WIRE GAUGE
- C CONDUIT
- C/B CIRCUIT BREAKER
- CAT CATALOG
- CKT CIRCUIT
- CU COPPER
- DWG DRAWING
- EC ELECTRICAL CONTRACTOR
- EM EMERGENCY
- ETD EXISTING TO BE DEMOLISHED
- ETR EXISTING TO REMAIN
- ETRL EXISTING TO BE RELOCATED
- ETRP EXISTING TO BE REPLACED
- G GROUND
- GC GENERAL CONTRACTOR
- GFI GROUND FAULT INTERRUPTER
- HVAC HEATING, VENTILATION, AIR CONDITIONING CONTRACTOR
- KVA KILOVOLT-AMPERES
- KVAR KILOVOLT-AMPERES REACTIVE
- KW KILOWATTS
- MCB MAIN CIRCUIT BREAKER
- MLO MAIN LUGS ONLY
- NC NORMALLY CLOSED
- NEC NATIONAL ELECTRICAL CODE
- NL NIGHT LIGHT
- NO NORMALLY OPEN
- NTS NOT TO SCALE
- Ø PHASE
- P POLE
- RL NEW LOCATION OF RELOCATED DEVICE
- SM SURFACE MOUNT
- T/D TEL/DATA
- TEL TELEPHONE
- UNO UNLESS NOTED OTHERWISE
- V VOLT
- VF VERIFY IN FIELD
- W WATT
- WP WEATHERPROOF

DEMOLITION AND REMOVAL WORK

- REMOVE ALL ELECTRICAL EQUIPMENT, WIRING, AND OTHER ELECTRICAL WORK AS REQUIRED. DISCONNECT LOAD AND LINE END OF CONDUCTORS FEEDING DEVICES WHICH ARE TO BE REMOVED OR ABANDONED. REMOVE CONDUCTORS NO LONGER IN USE. CUT BACK TO FLOOR, WALL, OR CEILING AND PLUG BOTH ENDS OF CONCEALED CONDUITS MADE OBSOLETE BY THIS ALTERATION. REMOVE EXPOSED OR ABANDONED CIRCUITS AND OUTLETS. REMOVE MATERIAL AND EQUIPMENT AND DISPOSE OF AS DIRECTED.
- WHEREVER IT IS REQUIRED TO DISCONNECT OR REMOVE ANY PART OF AN EXISTING CIRCUIT, IMMEDIATELY RECONNECT THAT CIRCUIT OR REESTABLISH SERVICE IN THE REMAINING PORTION OF THE CIRCUIT.
- THE WORK SHALL ALSO INCLUDE THE REMOVAL OF MATERIALS AS DIRECTED. PRIOR TO REMOVING EQUIPMENT AND MATERIAL FROM PROJECT SITE, THE BUILDING MANAGER OR OWNER WILL INSPECT AND ADVISE WHICH ITEMS WILL BE STORED.
- WHERE PRESENT WORK IS DAMAGED IN THE EXECUTION OF THIS CONTRACT, OR WHERE OPENINGS ARE LEFT DUE TO THE REMOVAL OF CONDUITS, EQUIPMENT, OR APPARATUS, THE SAME SHALL BE REPAIRED OR CLOSED UP TO CORRESPOND IN MATERIAL, QUALITY, SHAPE, AND FINISH WITH THAT OR SIMILAR AND ADJOINING WORK, UNLESS OTHERWISE CALLED FOR.
- SHOULD ANY DAMAGE DUE TO THE EXECUTION OF THIS CONTRACT OCCUR TO THE FURNITURE, FIXTURES, OR ANY OTHER EQUIPMENT OR APPARATUS, SUCH DAMAGES SHALL BE PROPERLY REPAIRED WITH THE SUPPLY OF NEW ARTICLES AND MADE GOOD WITHOUT EXTRA CHARGE.
- WHERE REMOVAL OF EXISTING ELECTRICAL EQUIPMENT WILL RESULT IN OUTAGES IN AREA NOT TO BE DEMOLISHED, THIS CONTRACTOR SHALL COORDINATE IN ADVANCE AND OBTAIN THE APPROVAL OF THE BUILDING MANAGER OR OWNER.

BRANCH CIRCUIT WIRING NOTES:

- WIRING IS SHOWN ON DRAWINGS ONLY FOR SPECIFIC ROUTES OR SPECIAL CONDITIONS.
- WIRING AND CONDUIT SHALL BE REQUIRED BETWEEN ALL OUTLETS INDICATED WITH CIRCUIT NUMBERS AND PANEL DESIGNATIONS.
- ALL SWITCH CONTROLS SHALL BE PROVIDED WITH WIRING AND CONDUIT AS REQUIRED.
- ALTHOUGH ALL BRANCH CIRCUIT WIRING AND CONDUIT IS NOT SHOWN, IT IS THE INTENT OF THESE DOCUMENTS THAT A COMPLETE BRANCH CIRCUIT WIRING SYSTEM BE INSTALLED.
- A GREEN GROUNDING CONDUCTOR SHALL BE RUN WITH ALL CIRCUITS. VERIFY CONDUIT SIZE TO ENSURE IT CAN ACCOMMODATE ALL PHASE, NEUTRAL AND GROUND CONDUCTORS.

NOTES FOR THE ELECTRICAL WORK

- THE JOBSITE WORKING HOURS FOR THIS PROJECT IS MONDAY THRU FRIDAY FROM 5:00 PM TO 12:00 AM.
- THE ELECTRICAL CONTRACTOR SHALL INCLUDE ALL COSTS ASSOCIATED WITH THE FIRE ALARM SYSTEM SHUTDOWNS SUCH AS THE FOLLOWING: THE WAKEFIELD FIRE DEPARTMENT COSTS, FIRE ALARM CONTROL PANEL'S MANUFACTURER'S FIELD TECHNICIANS, ETC. THE ELECTRICAL CONTRACTOR SHALL INCLUDE THE ABOVE REFERENCED COSTS IN THE ELECTRICAL BID.

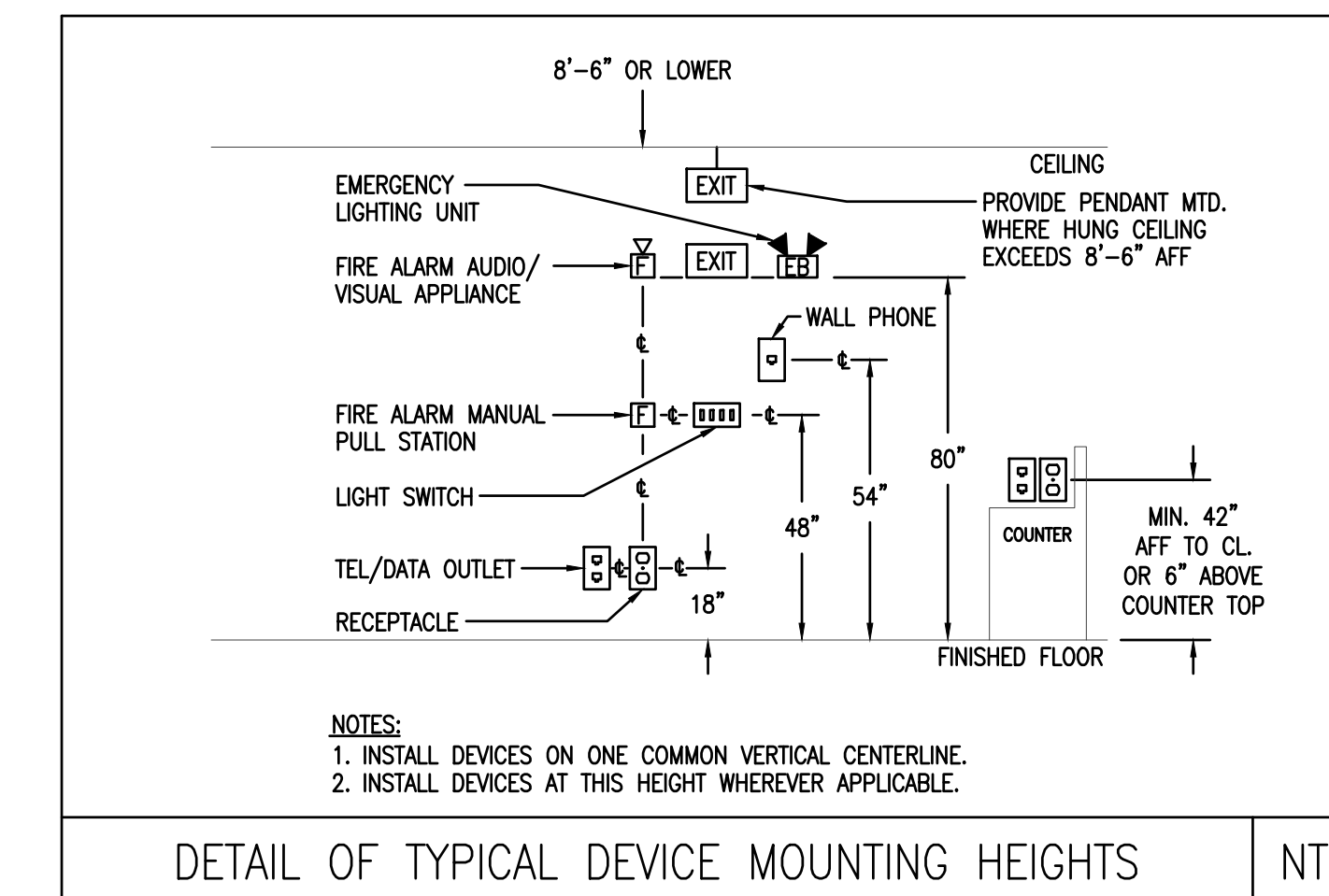

- NOTES:**
- INSTALL DEVICES ON ONE COMMON VERTICAL CENTERLINE.
 - INSTALL DEVICES AT THIS HEIGHT WHEREVER APPLICABLE.

DETAIL OF TYPICAL DEVICE MOUNTING HEIGHTS NTS

NOTES FOR FIRE ALARM SYSTEM RISER DIAGRAM:

- REFER TO FLOOR PLANS FOR EXACT QUANTITIES AND LOCATIONS OF ALL DEVICES. NOT ALL DEVICES AND APPLIANCES ARE INDICATED ON THE FIRE ALARM RISER DIAGRAM.
- THE FIRE ALARM SYSTEM SHALL CONFORM WITH THE REQUIREMENTS OF THE LOCAL FIRE DEPARTMENT. SHOP DRAWINGS SHALL BE SUBMITTED TO THE LOCAL FIRE DEPARTMENT FOR APPROVAL.
- ALL FIRE ALARM WIRING SHALL BE CLASS "X" PER THE MANUFACTURER'S RECOMMENDATIONS AND SHALL BE INSTALLED IN A MINIMUM 3/4" EMT CONDUIT.
- ALL FIRE ALARM WORK SHALL BE IN ACCORDANCE WITH THE LATEST EDITIONS OF NFPA, STATE, AND LOCAL BUILDING CODES AND THE AMERICANS WITH DISABILITIES ACT (ADA).
- THE ELECTRICAL CONTRACTOR SHALL PROVIDE A NON-ILLUMINATED GRAPHIC MAP. THE EXACT LAYOUT OF NON-ILLUMINATED GRAPHIC MAP SHALL BE APPROVED BY THE LOCAL FIRE DEPARTMENT.
- THE ELECTRICAL CONTRACTOR SHALL PROVIDE THE ANTENNA AND ANTENNA WIRING FOR THE FIRE ALARM RADIO MASTER BOX.
- THE ELECTRICAL CONTRACTOR SHALL PROVIDE TWO (2) DEDICATED TELEPHONE LINES IN A 1" CONDUIT TO THE MAIN COMMUNICATIONS BACKBOARD LOCATED IN TEL/DATA ROOMS.
- THE ELECTRICAL CONTRACTOR SHALL PROVIDE THE ISOLATION MODULE. (NOTE: PROVIDE A MINIMUM OF ONE (1) ISOLATION MODULE PER FLOOR AND ONE (1) ISOLATION MODULE PER EVERY TWENTY FIVE (25) DEVICES.)

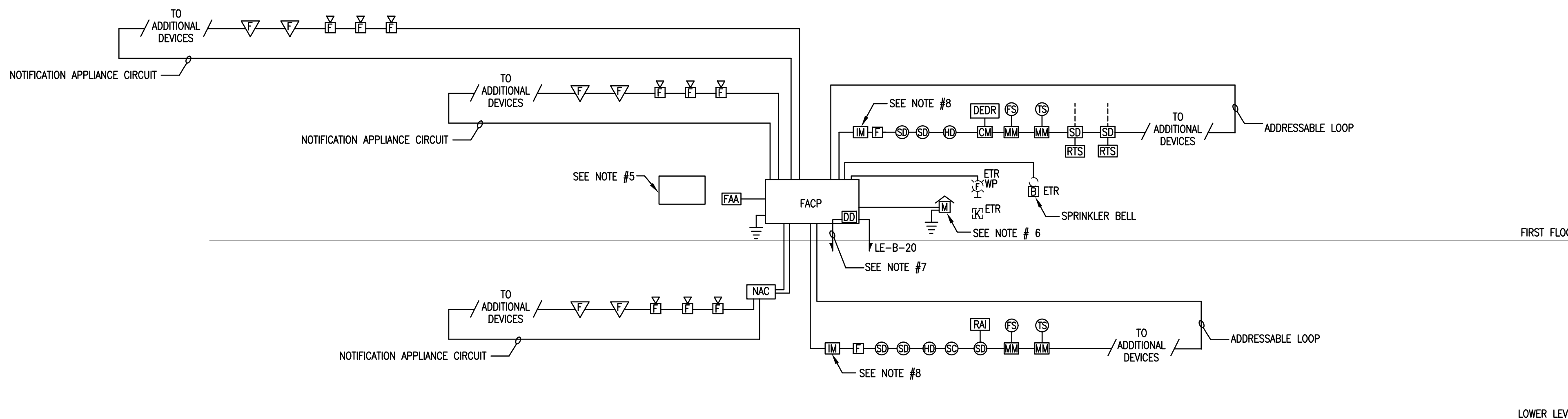

1 FIRE ALARM SYSTEM RISER DIAGRAM SCALE: NTS

FIRE ALARM UPGRADES
McGRATH JUDICIAL COMPLEX

400 Massachusetts Avenue
East Providence, Rhode Island
p. (401) 331-9200
f. (401) 331-9270

2 Hampshire Street
Suite 106, First Floor
Foxboro, Massachusetts
p. (774) 215-0200
f. (774) 215-0407

e-mail: rowse@rowsearch.com

Edward Rowse ARCHITECTS

OWNERSHIP AND USE OF DOCUMENTS, DRAWINGS AND SPECIFICATIONS AS INSTRUMENTS OF PROFESSIONAL SERVICE, ARE AND SHALL REMAIN, THE PROPERTY OF THE ARCHITECT. THESE DOCUMENTS ARE NOT TO BE USED, IN WHOLE OR IN PART, FOR ANY OTHER PROJECTS OR PURPOSES, OR BY ANY OTHER PARTIES THAN THOSE EXPRESSLY AUTHORIZED BY CONTRACT WITHOUT THE EXPRESS AUTHORIZATION OF THE ARCHITECT.

Date: JANUARY 30, 2020

Drawn by: cs Proj. Mgr.: dc

Revisions

No.	Date	Description

ELECTRICAL LEGEND, FIXTURE SCHEDULE AND NOTES

E0.01

EXISTING CONVENTIONAL FIRE ALARM SYSTEM ZONE SCHEDULE	
ZONE #1	FIRST FLOOR EAST - MANUAL PULL STATIONS, SMOKE DETECTORS, FLOW SWITCHES AND TAMPERS SWITCHES
ZONE #2	FIRST FLOOR WEST - MANUAL PULL STATIONS, SMOKE DETECTORS, FLOW SWITCHES AND TAMPERS SWITCHES
ZONE #3	RTU 10 EAST - DUCT SMOKE DETECTORS
ZONE #4	RTU 17 EAST - DUCT SMOKE DETECTORS
ZONE #5	RTU 11 EAST - DUCT SMOKE DETECTORS
ZONE #6	RTU 15 EAST - DUCT SMOKE DETECTORS
ZONE #7	RTU 16 EAST - DUCT SMOKE DETECTORS
ZONE #8	RTU 12 EAST - DUCT SMOKE DETECTORS
ZONE #9	RTU 8 EAST - DUCT SMOKE DETECTORS
ZONE #10	RTU 13 EAST - DUCT SMOKE DETECTORS
ZONE #11	RTU 14 EAST - DUCT SMOKE DETECTORS
ZONE #12	RTU 1 WEST - DUCT SMOKE DETECTORS
ZONE #13	RTU 2 WEST - DUCT SMOKE DETECTORS
ZONE #14	RTU 7 WEST - DUCT SMOKE DETECTORS
ZONE #15	RTU 3 WEST - DUCT SMOKE DETECTORS
ZONE #16	RTU 6 WEST - DUCT SMOKE DETECTORS
ZONE #17	RTU 9 WEST - DUCT SMOKE DETECTORS
ZONE #18	RTU 4 WEST - DUCT SMOKE DETECTORS
ZONE #19	RTU 5 WEST - DUCT SMOKE DETECTORS
ZONE #20	BASEMENT - MANUAL PULL STATION, PHOTOELECTRIC SMOKE DETECTOR, FLOW SWITCH AND TAMPERS SWITCH
ZONE #21	SPRINKLER MAIN - FLOW SWITCH AND TAMPERS SWITCH
ZONE #22	HALON SYSTEM

GENERAL NOTES:

- THE EXISTING FIRE ALARM SYSTEM SHALL REMAIN OPERATION UNTIL THE NEW ADDRESSABLE FIRE ALARM SYSTEM IS TESTED AND APPROVED BY THE LOCAL FIRE DEPARTMENT. AFTER THE APPROVAL OF THE NEW ADDRESSABLE FIRE ALARM SYSTEM, THE ELECTRICAL CONTRACTOR SHALL REMOVE THE EXISTING FIRE ALARM SYSTEM.
- THE ELECTRICAL CONTRACTOR SHALL PROVIDE "FIRE ALARM DEVICE NOT OPERATIONAL" SIGNS ON ALL THE EXISTING TO BE REMOVED FIRE ALARM DEVICES DURING THE FIRE ALARM SYSTEM DEMOLITION PHASE OF THE PROJECT.
- IF THE EXISTING FIRE ALARM SYSTEM BACK BOXES AND CONDUITS ARE INSTALLED IN THE BUILDING STRUCTURE, THEN THE BACK BOXES AND CONDUITS SHALL REMAIN AND THE FIRE ALARM SYSTEM WIRING CONDUCTORS SHALL BE REMOVED. PROVIDE METAL BEVELED BLANK PLATES FOR THE BACK BOXES AND CAP THE EMPTY CONDUITS.

NOTES FOR THE LOWER LEVEL FIRE ALARM DEMOLITION PLAN:

- THE ELECTRICAL CONTRACTOR SHALL DISCONNECT AND REMOVE THE EXISTING FIRE ALARM SYSTEM WIRING AT THE EXISTING TO BE REUSED SPRINKLER WATER FLOW SWITCH.
- THE ELECTRICAL CONTRACTOR SHALL DISCONNECT AND REMOVE THE EXISTING FIRE ALARM SYSTEM WIRING AT THE EXISTING TO BE REUSED SPRINKLER TAMPERS SWITCH.

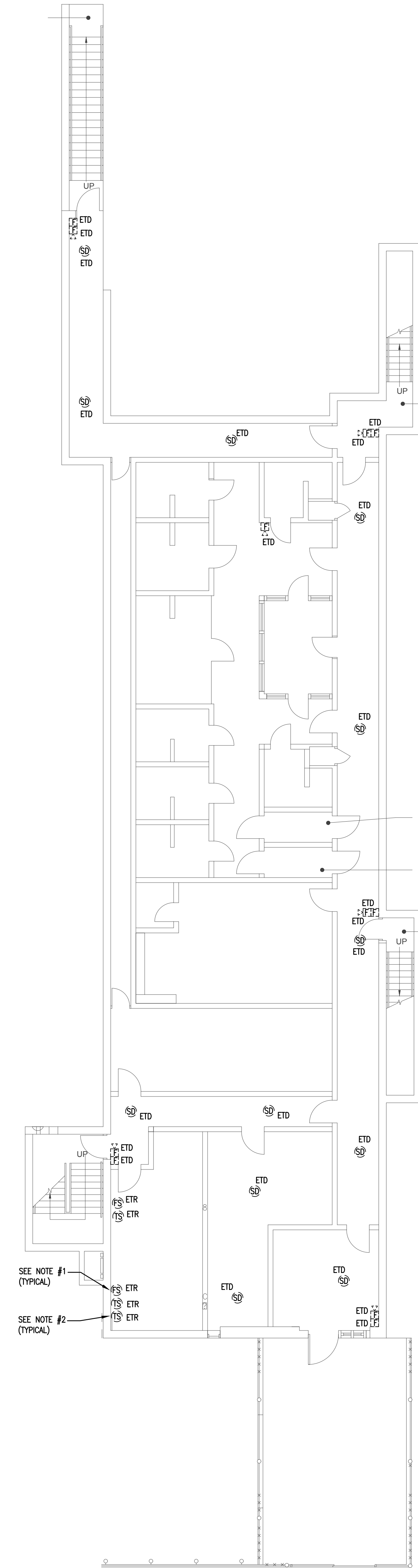

1 ED1.00 LOWER LEVEL FIRE ALARM DEMOLITION PLAN
SCALE: 1/8" = 1'-0"

OWNERSHIP AND USE OF DOCUMENTS, DRAWINGS AND SPECIFICATIONS AS INSTRUMENTS OF PROFESSIONAL SERVICE, ARE AND SHALL REMAIN THE PROPERTY OF THE ARCHITECT. THESE DOCUMENTS ARE NOT TO BE USED, IN WHOLE OR IN PART, FOR ANY OTHER PROJECTS OR PURPOSES, OR BY ANY OTHER PARTIES THAN THOSE PROPERLY AUTHORIZED BY CONTRACT WITHOUT THE EXPRESS AUTHORIZATION OF THE ARCHITECT.

Date: JANUARY 30, 2020
Drawn by: cs Proj. Mgr.: dc

Revisions		
No.	Date	Description

LOWER LEVEL FIRE ALARM DEMOLITION PLAN

FIRE ALARM UPGRADES

McGRATH JUDICIAL COMPLEX

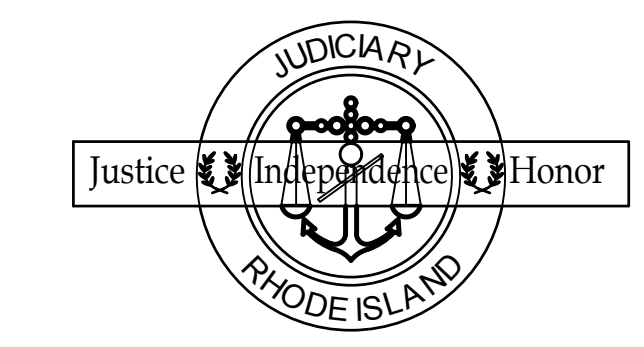

4800 TOWER HILL ROAD
WAKEFIELD, RHODE ISLAND

Edward Rowse ARCHITECTS

400 Massachusetts Avenue Suite 300, Second Floor East Providence, Rhode Island p. (401) 331-9200 f. (401) 331-9270
21 Hampshire Street Suite 106, First Floor Foxboro, Massachusetts p. (774) 215-0200 f. (774) 215-0497
e-mail: rowse@rowsearch.com

OWNERSHIP AND USE OF DOCUMENTS, DRAWINGS AND SPECIFICATIONS AS INSTRUMENTS OF PROFESSIONAL SERVICE, ARE AND SHALL REMAIN THE PROPERTY OF THE ARCHITECT. THESE DOCUMENTS ARE NOT TO BE USED, IN WHOLE OR IN PART, FOR ANY OTHER PROJECTS OR PURPOSES, OR BY ANY OTHER PARTIES THAN THOSE EXPRESSLY AUTHORIZED BY CONTRACT WITHOUT THE EXPRESS AUTHORIZATION OF THE ARCHITECT.

GENERAL NOTES:

- A. THE EXISTING FIRE ALARM SYSTEM SHALL REMAIN OPERATION UNTIL THE NEW ADDRESSABLE FIRE ALARM SYSTEM IS TESTED AND APPROVED BY THE LOCAL FIRE DEPARTMENT. AFTER THE APPROVAL OF THE NEW ADDRESSABLE FIRE ALARM SYSTEM, THE ELECTRICAL CONTRACTOR SHALL REMOVE THE EXISTING FIRE ALARM SYSTEM.
- B. THE ELECTRICAL CONTRACTOR SHALL PROVIDE "FIRE ALARM DEVICE NOT OPERATIONAL" SIGNS ON ALL THE EXISTING TO BE REMOVED FIRE ALARM DEVICES DURING THE FIRE ALARM SYSTEM DEMOLITION PHASE OF THE PROJECT.
- C. IF THE EXISTING FIRE ALARM SYSTEM BACK BOXES AND CONDUITS ARE INSTALLED IN THE BUILDING STRUCTURE, THEN THE BACK BOXES AND CONDUITS SHALL REMAIN AND THE FIRE ALARM SYSTEM WIRING CONDUCTORS SHALL BE REMOVED. PROVIDE METAL BEVELED BLANK PLATES FOR THE BACK BOXES AND CAP THE EMPTY CONDUITS.

NOTES FOR THE FIRST FLOOR FIRE ALARM DEMOLITION PLAN:

1. THE EXISTING CONNECTIONAL SMOKE DETECTOR IN CORRIDOR 171 IS MOUNTED ON THE ANGLED BEAM.
2. THE ELECTRICAL CONTRACTOR SHALL DISCONNECT AND REMOVE THE EXISTING FIRE ALARM SYSTEM WIRING AT THE EXISTING TO BE REUSED SPRINKLER WATER FLOW SWITCH.
3. THE ELECTRICAL CONTRACTOR SHALL DISCONNECT AND REMOVE THE EXISTING FIRE ALARM SYSTEM WIRING AT THE EXISTING TO BE REUSED SPRINKLER TAMPER SWITCH.
4. THE ELECTRICAL CONTRACTOR SHALL DISCONNECT AND REMOVE THE EXISTING FIRE ALARM SYSTEM WIRING AT THE EXISTING TO BE REUSED HALON SYSTEM CONTROL PANEL.
5. THE ELECTRICAL CONTRACTOR SHALL REMOVE THE FIRE ALARM MASTER BOX WIRING. PROVIDE A NECA 3R BLANK PLATE FOR THE FIRE ALARM MASTER BOX RECESSED ENCLOSURE.

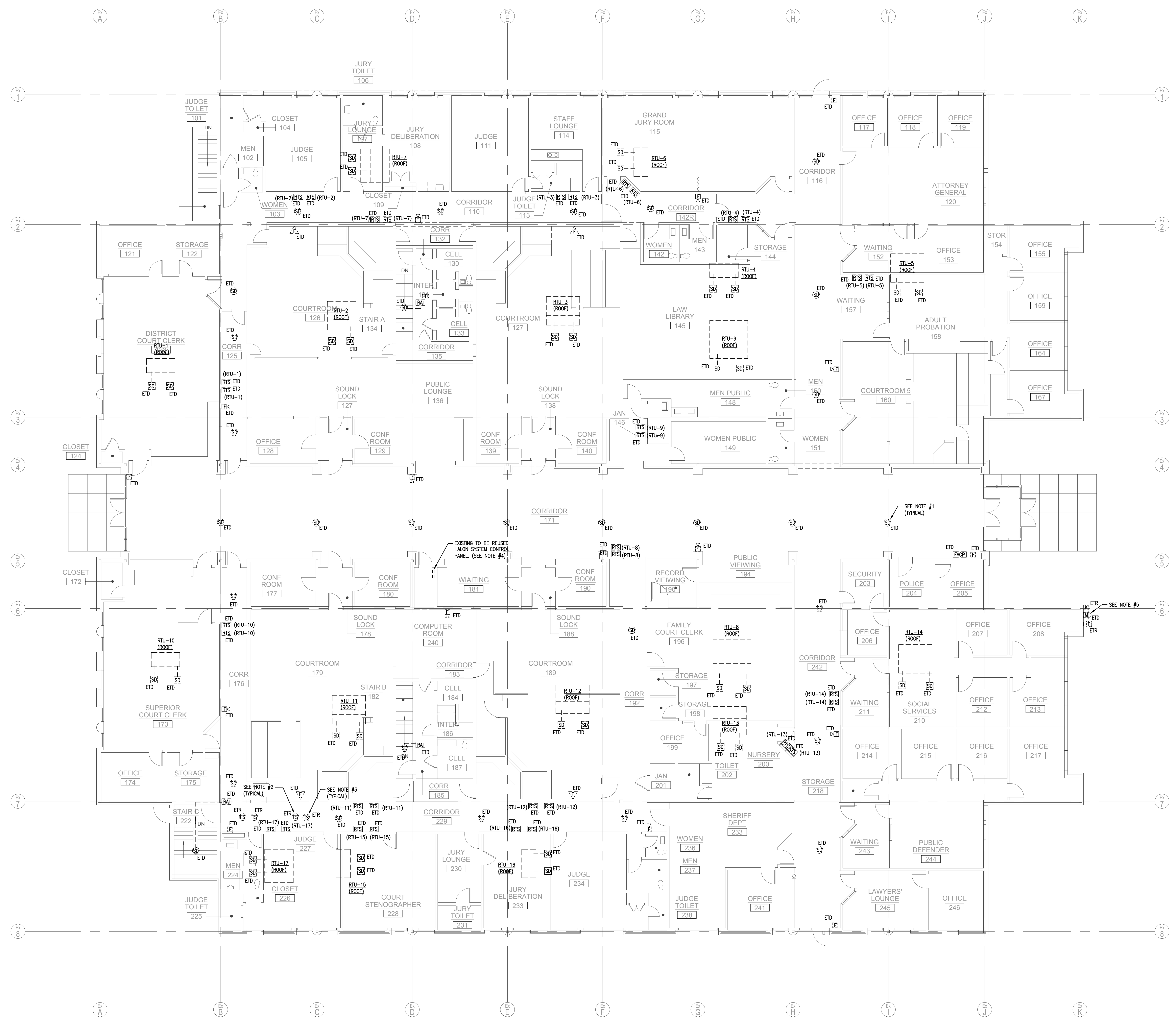

1 FIRST FLOOR FIRE ALARM DEMOLITION PLAN
ED1.01 SCALE: 1/8" = 1'-0"

FIRST FLOOR FIRE ALARM DEMOLITION PLAN

ED1.01

**FIRE ALARM
UPGRADES**

McGRATH JUDICIAL COMPLEX

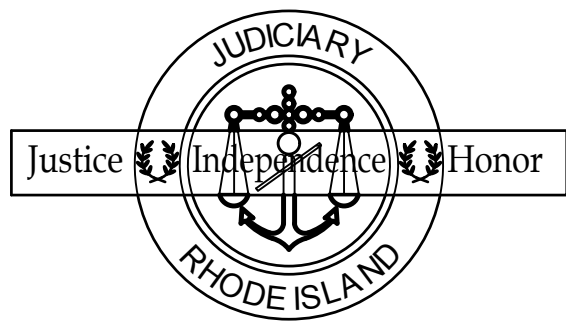

4800 TOWER HILL ROAD
WAKEFIELD, RHODE ISLAND

**Edward Rowse
ARCHITECTS**

400 Massachusetts Avenue Suite 300, Second Floor East Providence, Rhode Island p. (401) 331-9200 f. (401) 331-9270 e-mail: rowse@rowsearch.com
2 Hampshire Street Suite 106, First Floor Foxboro, Massachusetts p. (774) 215-0200 f. (774) 215-0497

OWNERSHIP AND USE OF DOCUMENTS, DRAWINGS AND SPECIFICATIONS AS INSTRUMENTS OF PROFESSIONAL SERVICE, ARE, AND SHALL REMAIN, THE PROPERTY OF THE ARCHITECT. THESE DOCUMENTS ARE NOT TO BE USED, IN WHOLE OR IN PART, FOR ANY OTHER PROJECTS OR PURPOSES, OR BY ANY OTHER PARTIES THAN THOSE EXPRESSLY AUTHORIZED BY CONTRACT WITHOUT THE EXPRESS AUTHORIZATION OF THE ARCHITECT.

GENERAL NOTES:

- A. THE NEW FIRE ALARM SYSTEM DEVICES SHALL BE SURFACE MOUNTED ON BLOCK WALLS. THE NEW FIRE ALARM DEVICES INSTALLED ON BLOCK WALLS SHALL HAVE THE FIRE ALARM SYSTEM WIRING INSTALLED IN SURFACE METAL RACEWAY.
- B. THE NEW FIRE ALARM REMOTE ANNUNCIATOR IN THE CONTROL ROOM SHALL BE SURFACE MOUNTED.

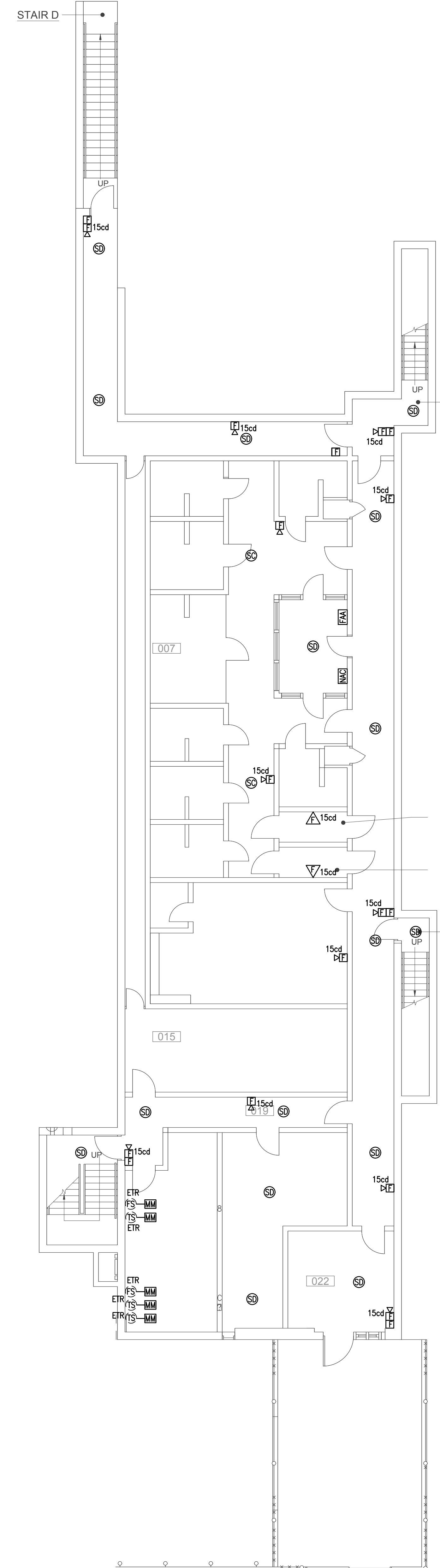

1 LOWER LEVEL FIRE ALARM PLAN
E1.00 SCALE: 1/8" = 1'-0"

Date: JANUARY 30, 2020
 Drawn by: cs Proj. Mgr.: dc
Revisions

No.	Date	Description

**LOWER LEVEL
FIRE ALARM
PLAN**

E1.00

FIRE ALARM UPGRADES

McGRATH JUDICIAL COMPLEX

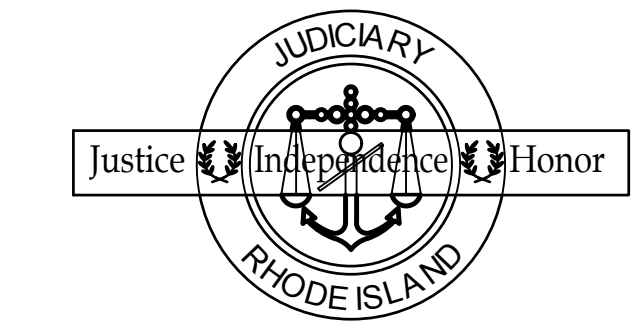

4800 TOWER HILL ROAD
WAKEFIELD, RHODE ISLAND

Edward Rowse ARCHITECTS

400 Massachusetts Avenue Suite 300, Second Floor East Providence, Rhode Island p. (401) 331-9000 f. (401) 331-9270
21 Hampshire Street Suite 106, First Floor Foxboro, Massachusetts p. (774) 215-0200 f. (774) 215-0497
e-mail: rowse@rowsearch.com

OWNERSHIP AND USE OF DOCUMENTS, DRAWINGS AND SPECIFICATIONS AS INSTRUMENTS OF PROFESSIONAL SERVICE, ARE AND SHALL REMAIN THE PROPERTY OF THE ARCHITECT. THESE DOCUMENTS ARE NOT TO BE USED, IN WHOLE OR IN PART, FOR ANY OTHER PROJECTS OR PURPOSES, OR BY ANY OTHER PARTIES THAN THOSE EXPRESSLY AUTHORIZED BY CONTRACT WITHOUT THE EXPRESS AUTHORIZATION OF THE ARCHITECT.

NOTES FOR THE FIRST FLOOR FIRE ALARM PLAN:

- THE NEW ADDRESSABLE SMOKE DETECTOR IN CORRIDOR 117 IS MOUNTED ON THE ANGLE BEAM.
- THE ELECTRICAL CONTRACTOR SHALL PROVIDE THE RADIO MASTER BOX WIRING IN A 1" CONDUIT. (NOTE: THE ELECTRICAL CONTRACTOR SHALL INSTALL THE EXTERNAL HIGH GAIN FIBERGLASS ANTENNA AND ANTENNA WIRING. COORDINATE THE ANTENNA LOCATION IN THE FIELD PRIOR TO INSTALLING.)
- THE ELECTRICAL CONTRACTOR SHALL PROVIDE A CATEGORY 6 CABLE IN A 3/4" CONDUIT FROM THE FIRE ALARM CONTROL PANEL ETHERNET PORT TO THE COMPUTER PATCH PANELS. COORDINATE PATCH PANEL AND PORT NUMBER WITH THE OWNER'S PROJECT REPRESENTATIVE.
- THE ELECTRICAL CONTRACTOR SHALL WIRE THE REMOVE FIRE ALARM SYSTEM DRILL SWITCH TO THE FIRE ALARM CONTROL PANEL. PROVIDE WIRING PER THE FIRE ALARM SYSTEM MANUFACTURER'S REQUIREMENTS.
- THE ELECTRICAL CONTRACTOR SHALL INSTALL THE FIRE ALARM ANNUNCIATOR IN THE EXISTING FIRE ALARM CONTROL PANEL BACK BOX. PROVIDE NEW METAL FACEPLATE FOR THE EXISTING TO BE REUSED FIRE ALARM CONTROL PANEL BACK BOX.
- THE ELECTRICAL CONTRACTOR SHALL RELOCATE THE EXISTING TO BE REUSED FIRE ALARM BEACON FIRE ALARM WIRING FROM THE EXISTING TO BE REMOVED FIRE ALARM CONTROL PANEL TO THE NEW FIRE ALARM CONTROL PANEL. MODIFY THE ABOVE REFERENCED FIRE ALARM WIRING AS REQUIRED.



SEE NOTE #1
(TYPICAL)

SEE NOTE #5

SEE NOTE #6

SEE NOTE #4

SEE NOTE #2

SEE NOTE #3

SEE NOTE #6

1 FIRST FLOOR FIRE ALARM PLAN
E1.01 SCALE: 1/8" = 1'-0"

Date: JANUARY 30, 2020		
Drawn by: cs Proj. Mgr.: dc		
Revisions		
No.	Date	Description

FIRST FLOOR FIRE ALARM PLAN

E1.01